

PERSPECTIVE

using vanishing points

By Peter Legun

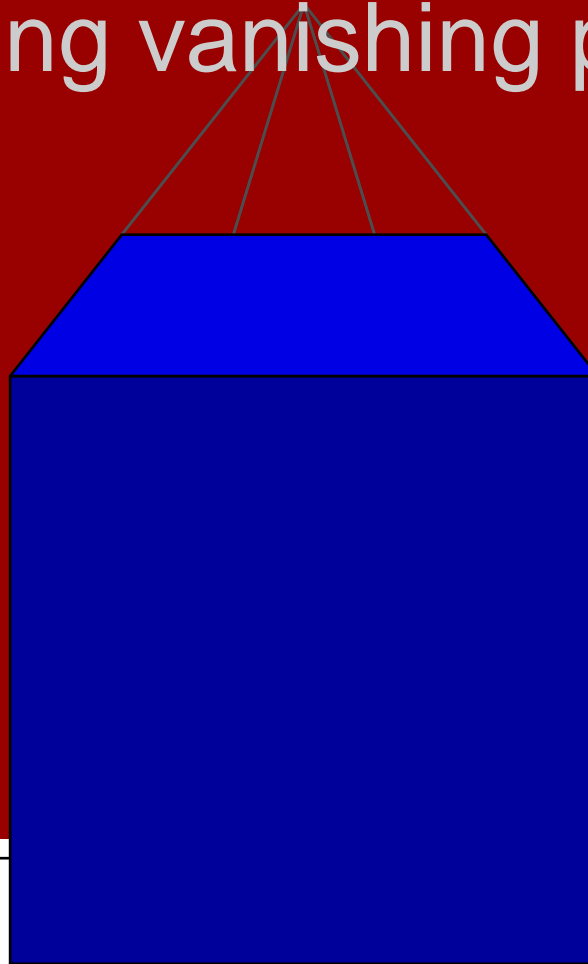

This text is based on perspective as used by the masters of the renaissance. It focuses on the use of vanishing points for drawing a cube. Although there are no numbers, the process is entirely reliant on mathematics and the concept of euclidean space. The numbers are contained in the lines and the geometry, and are relatively unimportant. What is important is the relationships of the lines to each other. Because of the lack of numerical calculations involved, it should be possible for anybody to learn perspective regardless of arithmetic ability. In fact, it is entirely feasible to teach a ten year old child all the rules of perspective drawing, which speaks of the limitations imposed by applying numbers and abstract variables to the understanding of physical relationships. The invention of perspective cannot be credited to one man, but certainly one of the greatest contributors was Leon Battista Alberti (1404 — 1472) who was one of the first to provide a thorough text. Giotto di Bondone (c. 1267 - 1337) also deserves credit for painting using perspective far before its time.

The Horizon:

Draw a straight line through the approximate center of the page. you can pick any straight line, and it need not be parallel to the bottom of the page; however, the horizon line represents your eyelevel. If you put it near the bottom, it will appear as if you are looking up. If you put it near the top, it will appear as if you are looking down. If the horizon line is tilted, it will look like the viewer is tilted or standing on a tilted surface.

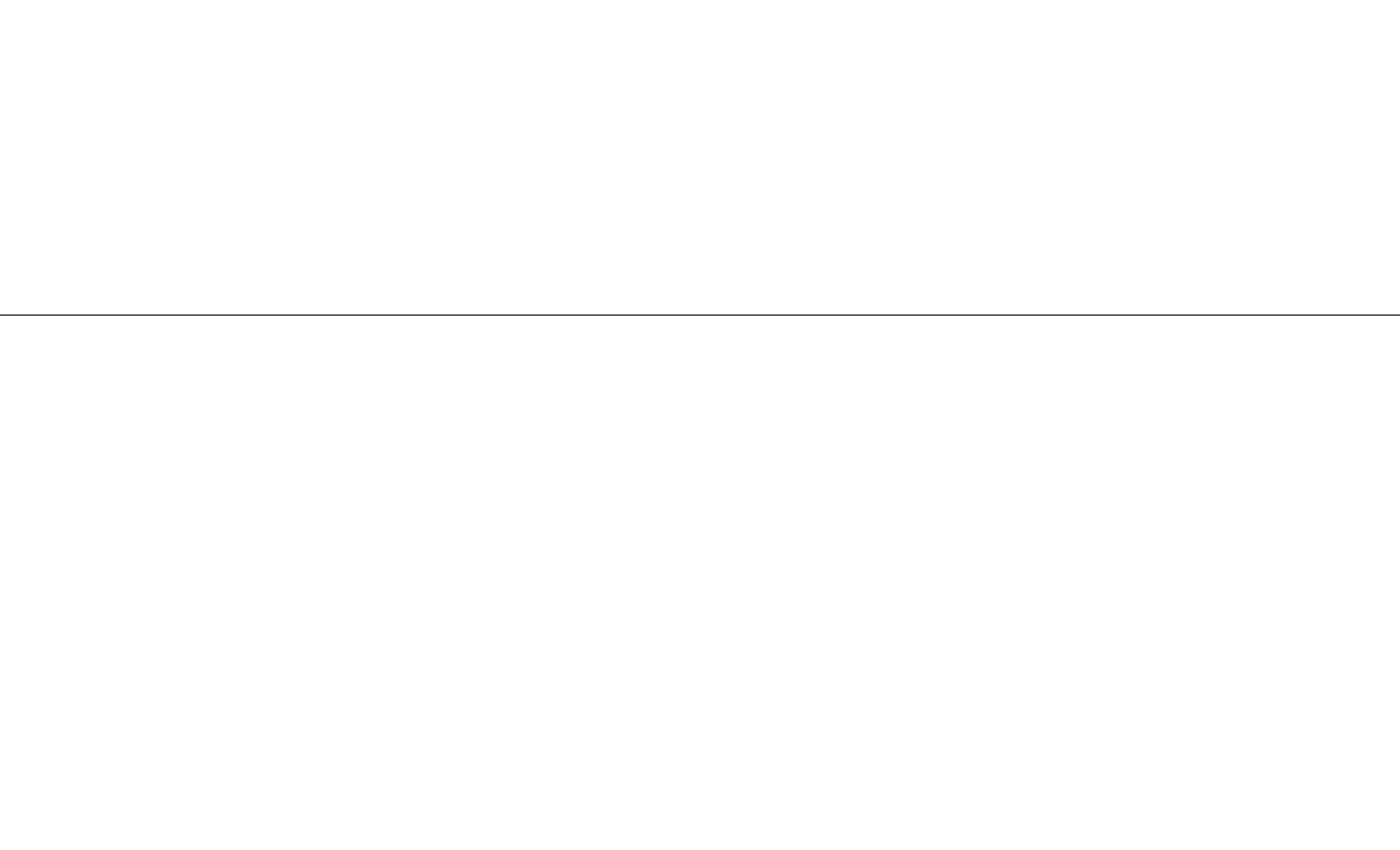

The Vanishing-Point:

Pick a point on the horizon line near the center. This is the point to which all lines perpendicular to the plane of the page will converge. This is called "single-point perspective." It is really just a special case of "three-point perspective," which will be explained later. Single-point perspective works well for drawing things in a limited depth of field, where objects are about the same size as the viewer.

VP



Drawing a cube using a single vanishing point:

The front and the back face of the cube must appear to be squares, because they are parallel to the picture plane. It is easiest to start with the front face.

VP

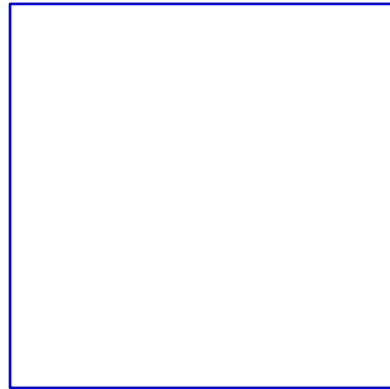

VP

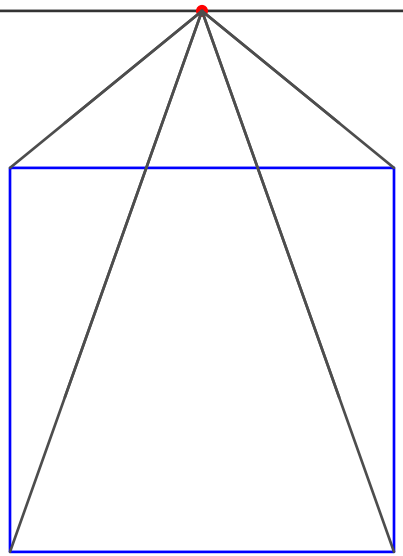

VP

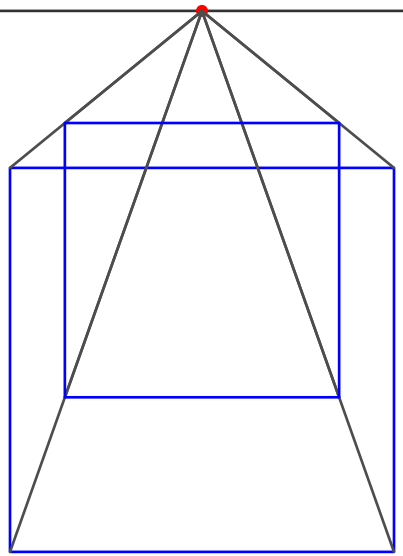

Now draw a line from each corner of the square to the vanishing-point. You can pick the back face of the cube arbitrarily within the diverging lines.

VP

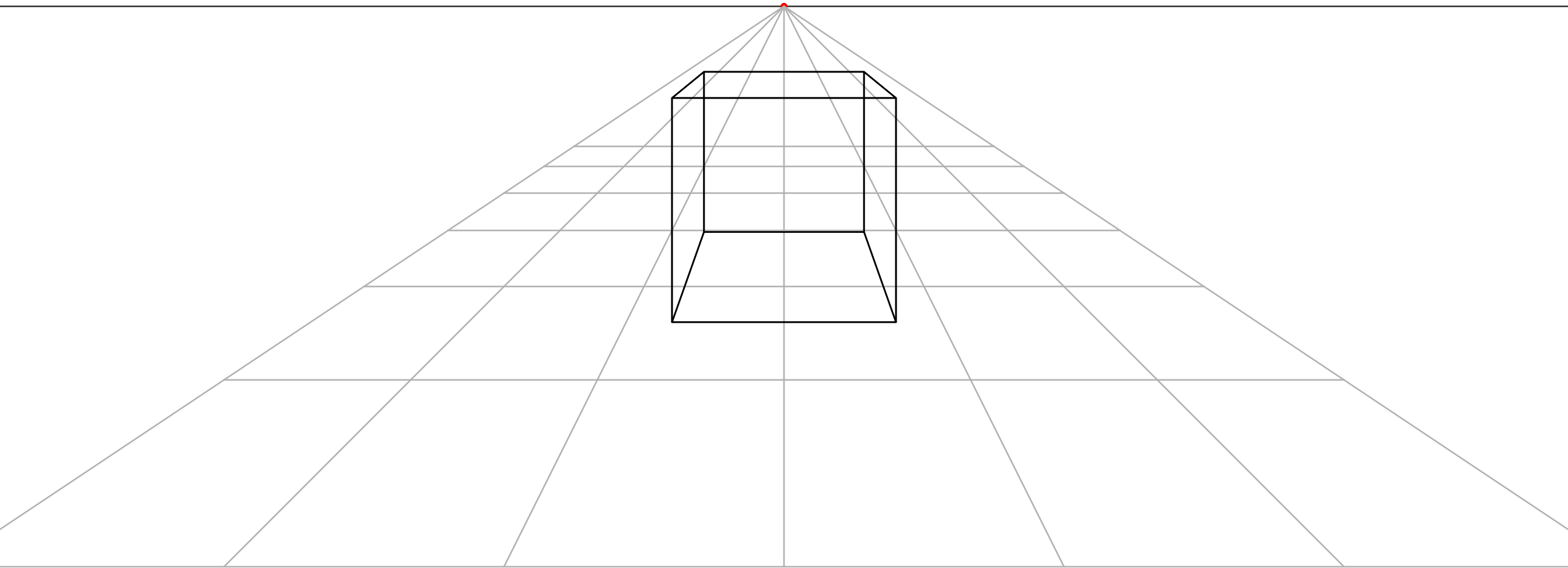

Here I have added a grid to indicate the floor. It is still ambiguous whether the cube is on the floor or above it. To solve this a shadow is required. An in depth treatment of the perspective of shadows will be left for another occasion.

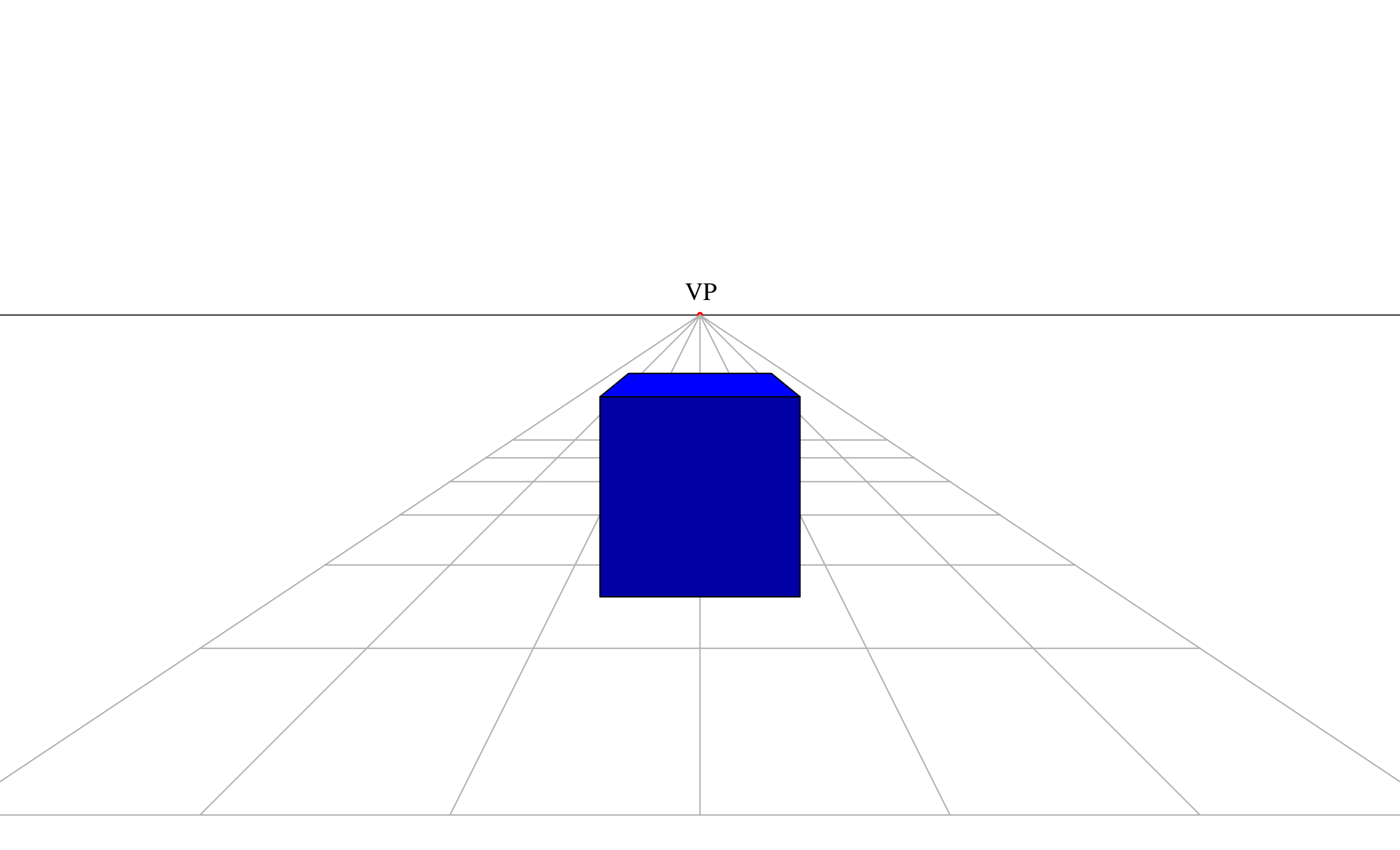

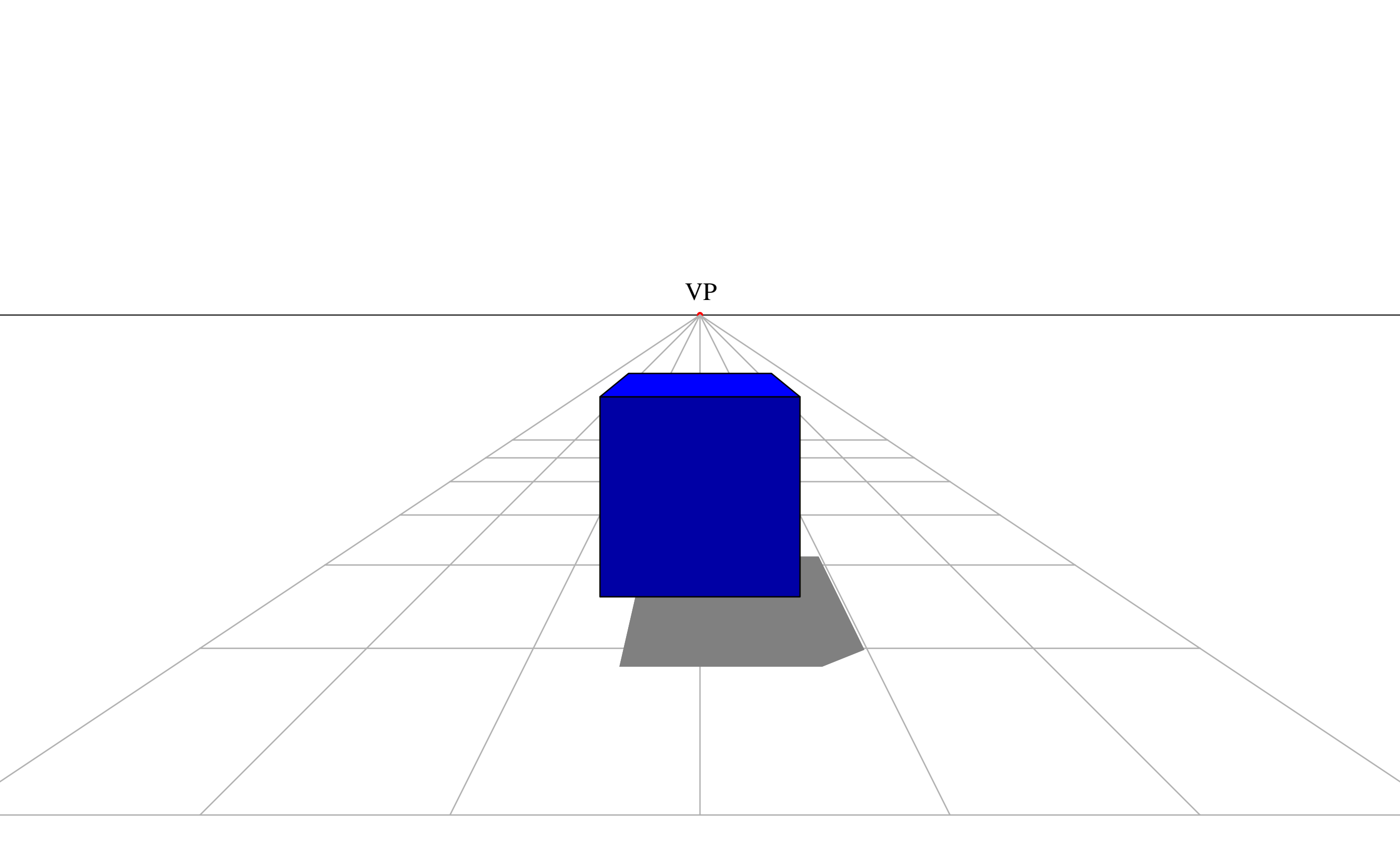

Notice that if the cube is constructed very far to the side of the page, it looks incorrect. This is the limit of the single point approximation. If the front face of the cube is parallel to the picture plane then in reality, that is the only face we should see and the other sides should be hidden.

VP

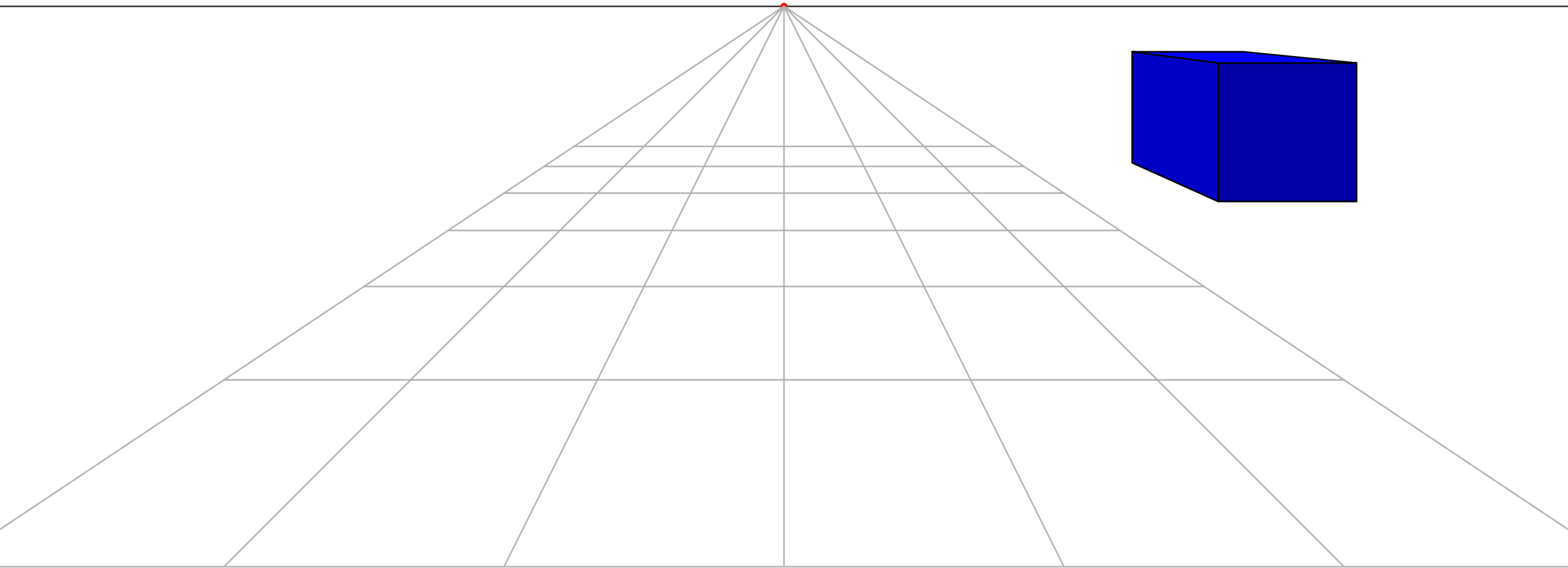

Single-point perspective is a special case of two-point perspective, where the horizontal lines converge at infinity. By rotating around the vertical axis, the second vanishing point can be brought into view.

VP

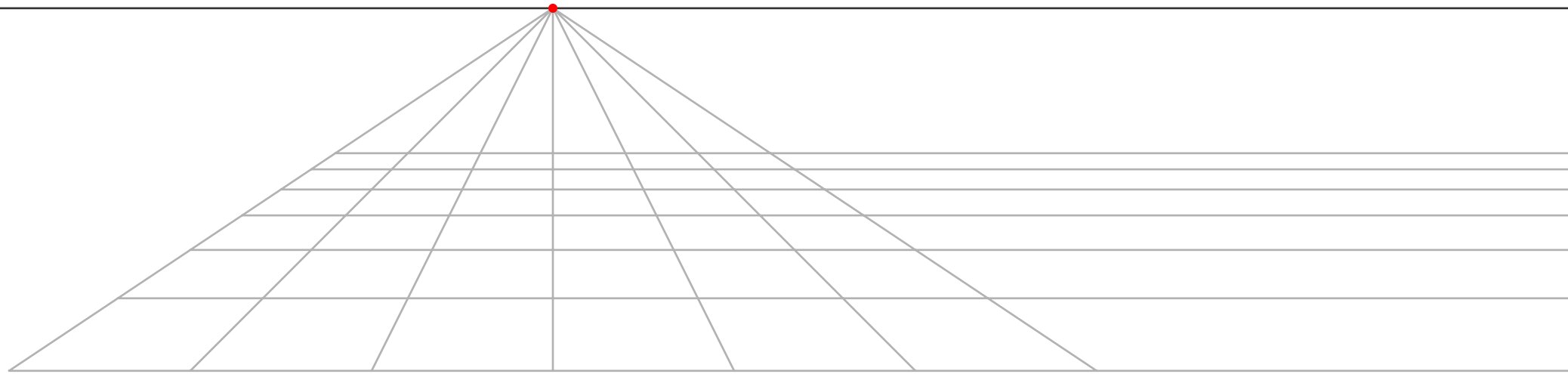

VP

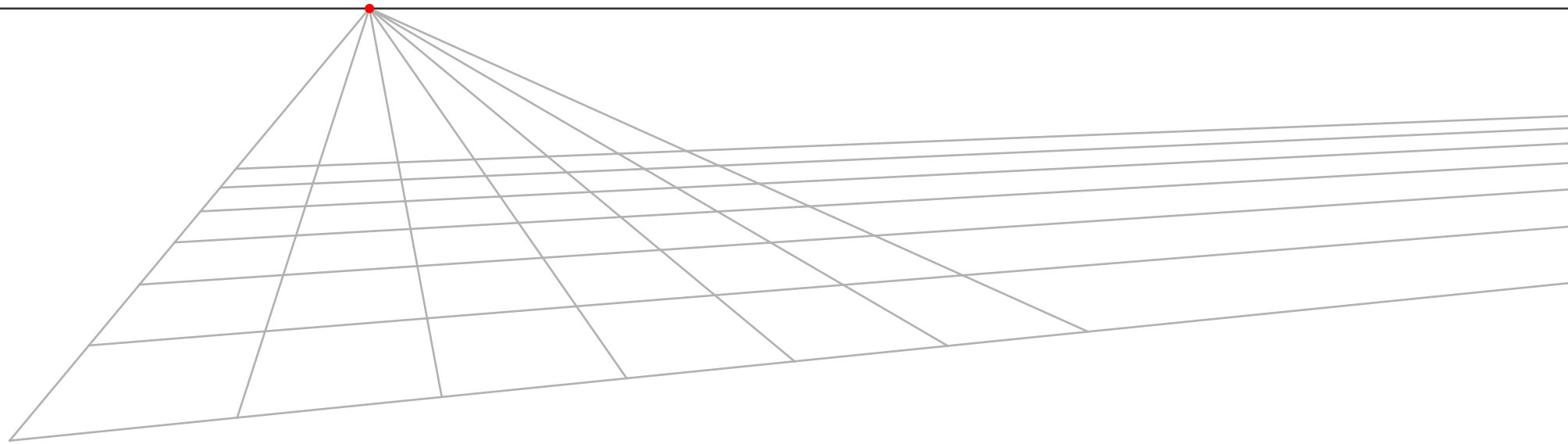

VP

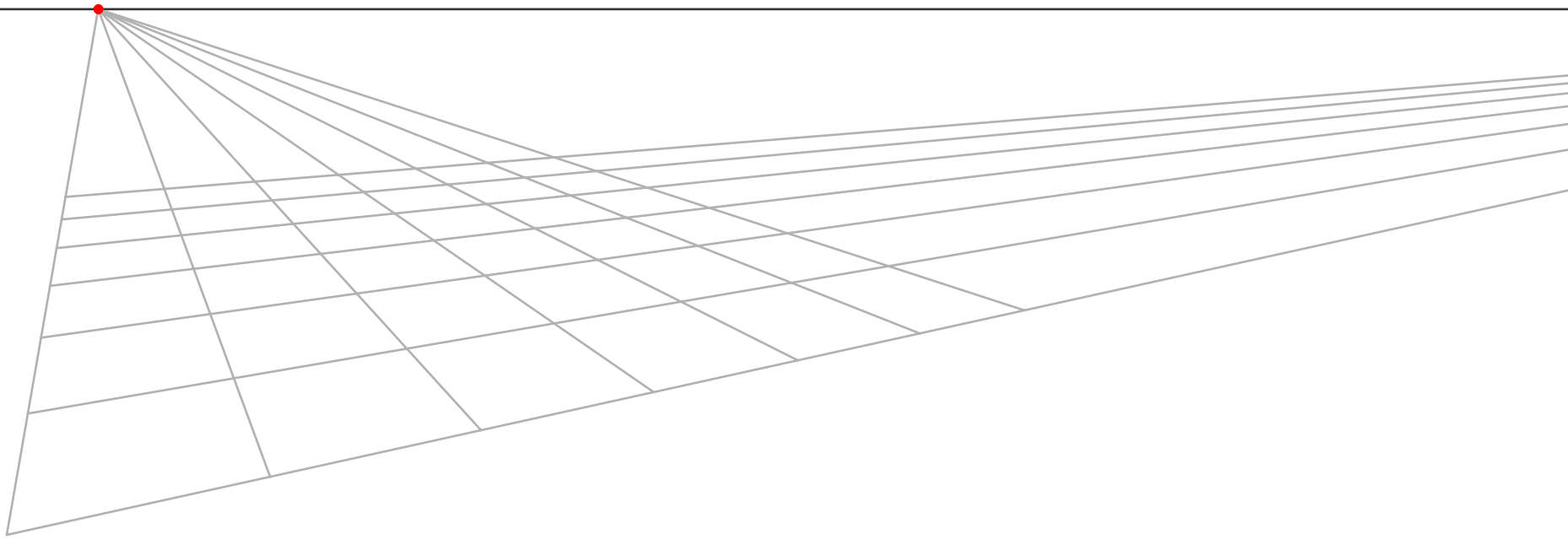

VP

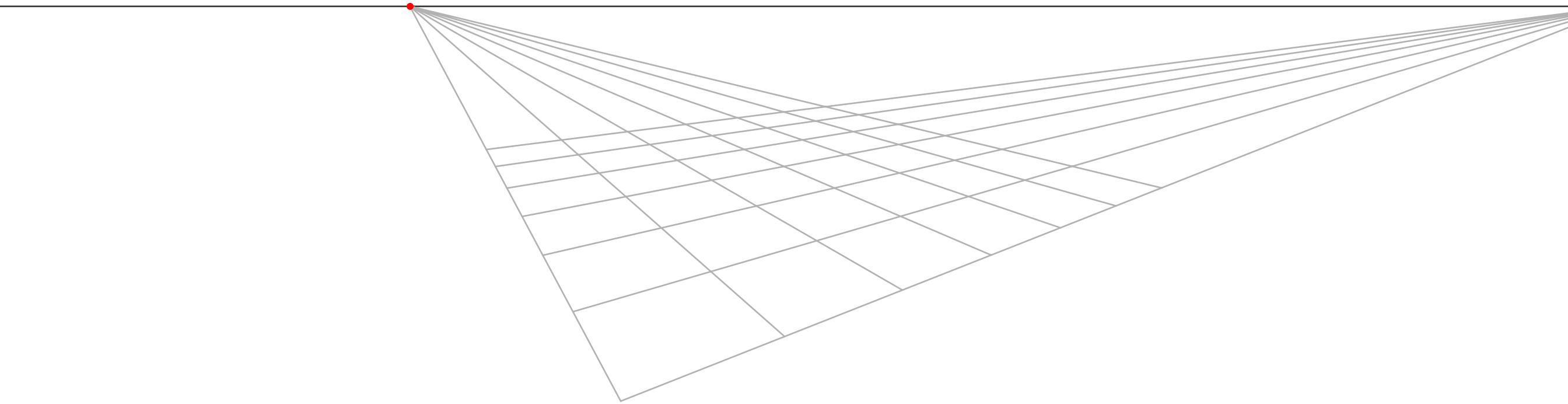

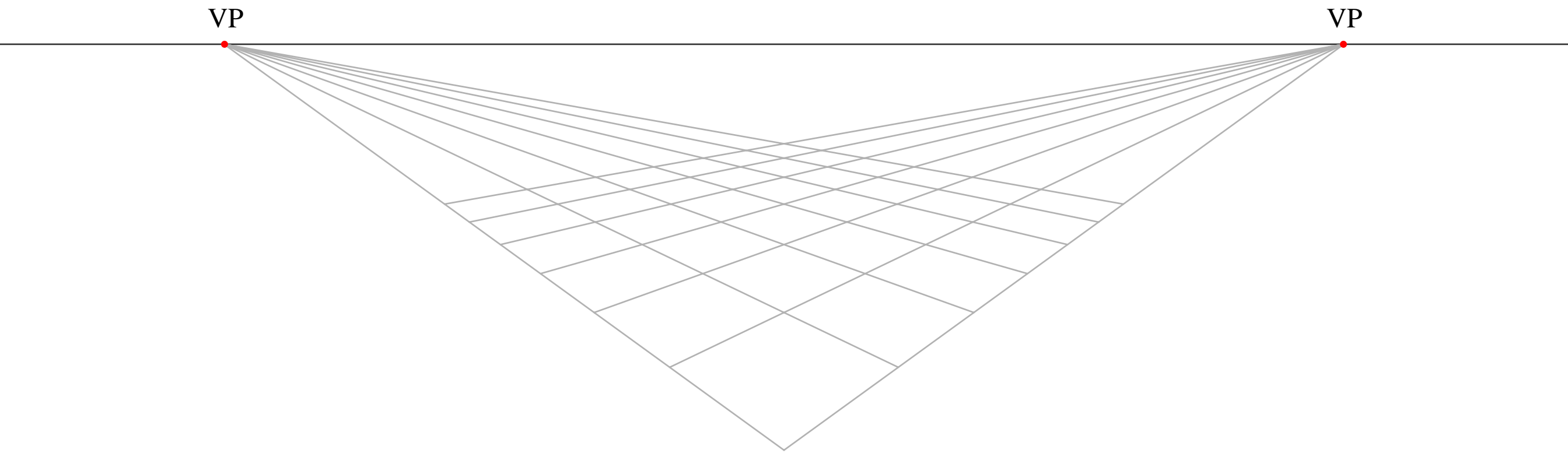

Two-point perspective:

Now there are two axes converging on the page. Instead of the front and back faces of a cube being parallel to the picture plane as in single-point perspective, the four vertical edges of a cube are now parallel.

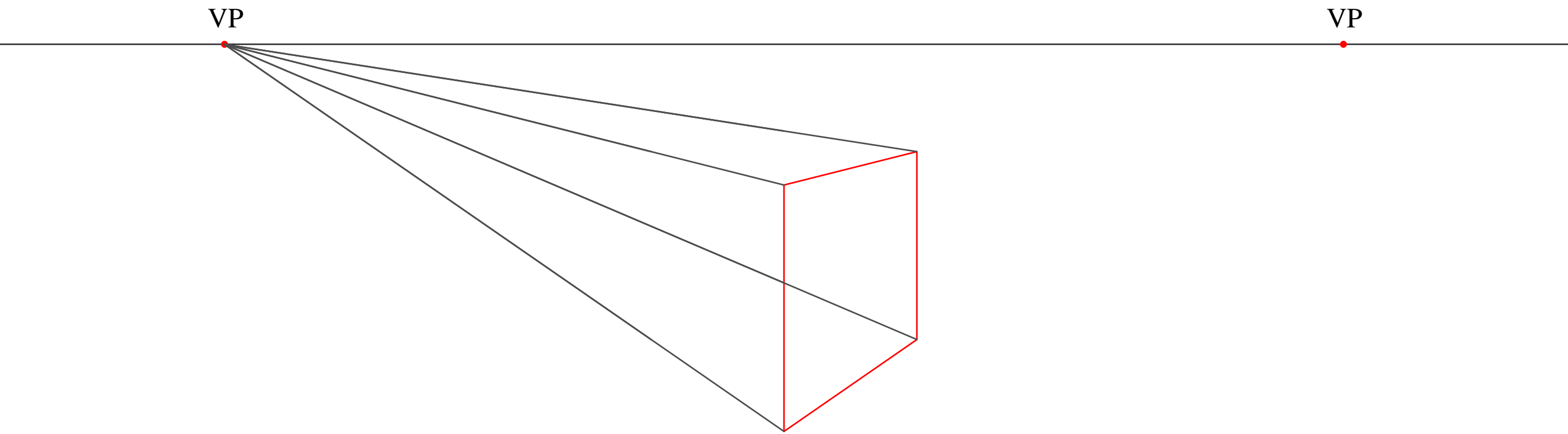

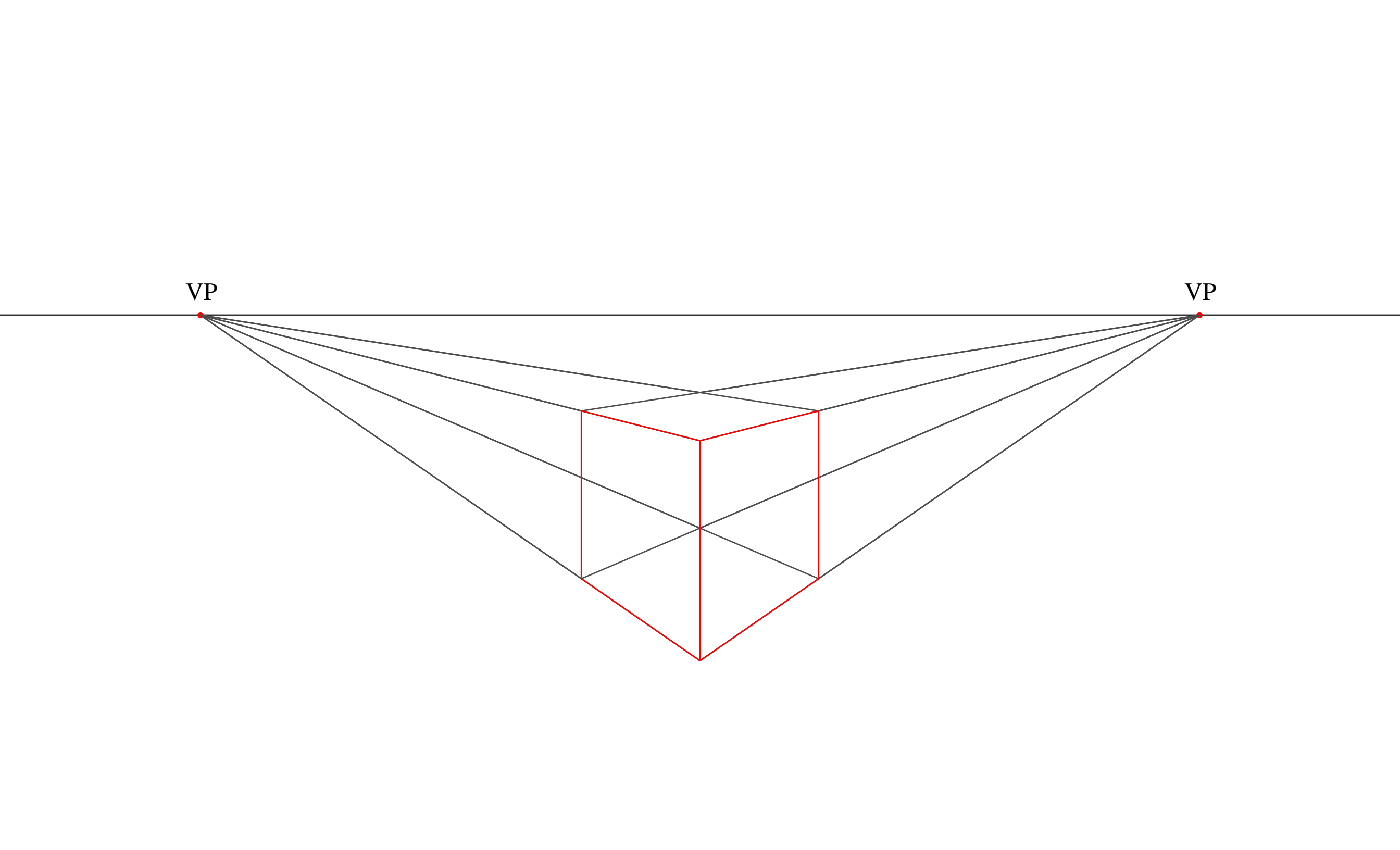

VP

VP

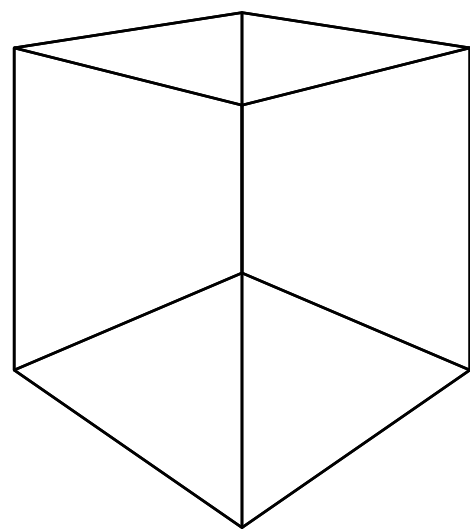

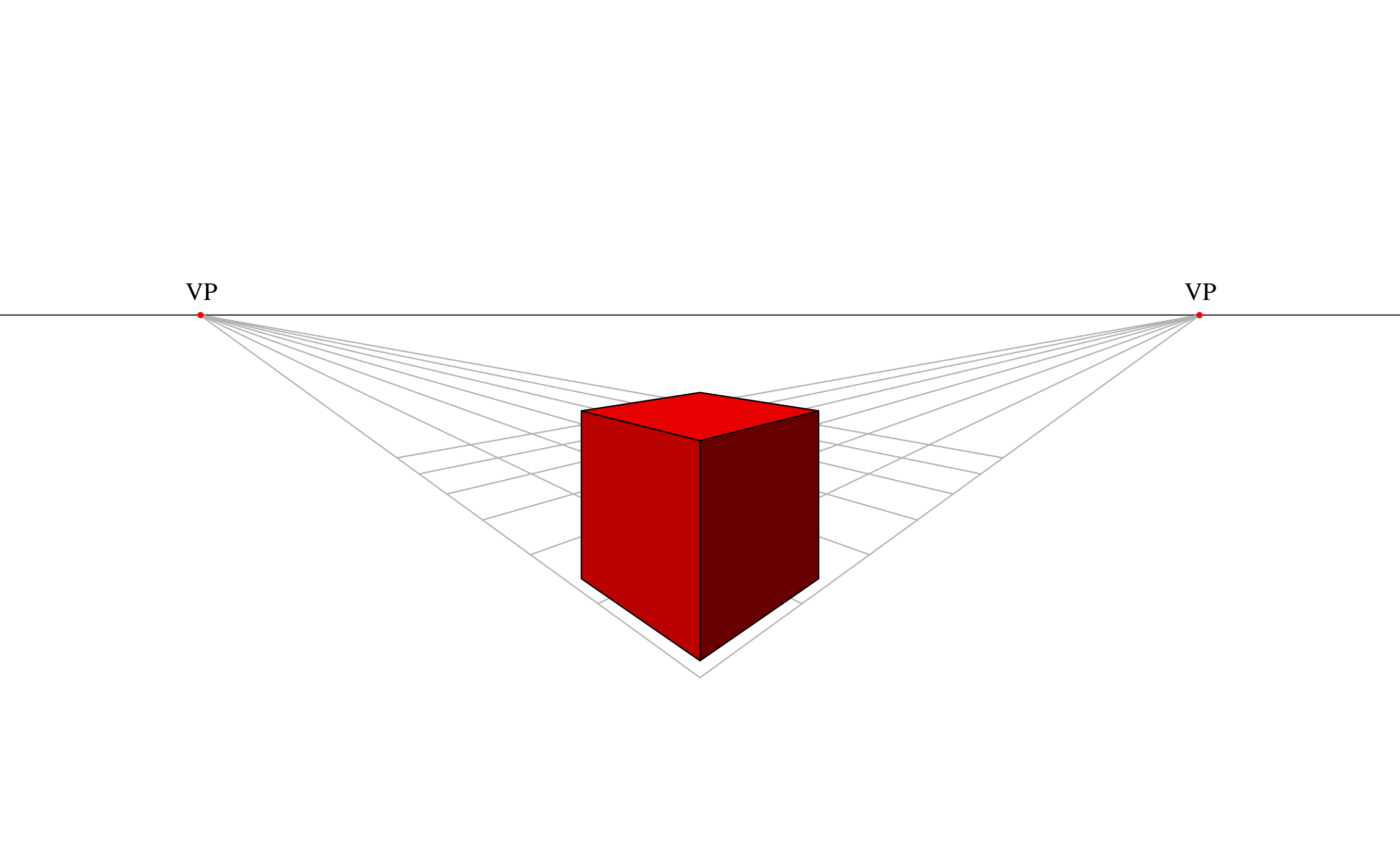

Two-point perspective is a special case of three-point perspective where the last vanishing point is at infinity along a line perpendicular to the horizon line. This "vertical horizon line" intersects the horizon at the mid-point of the two first vanishing points.

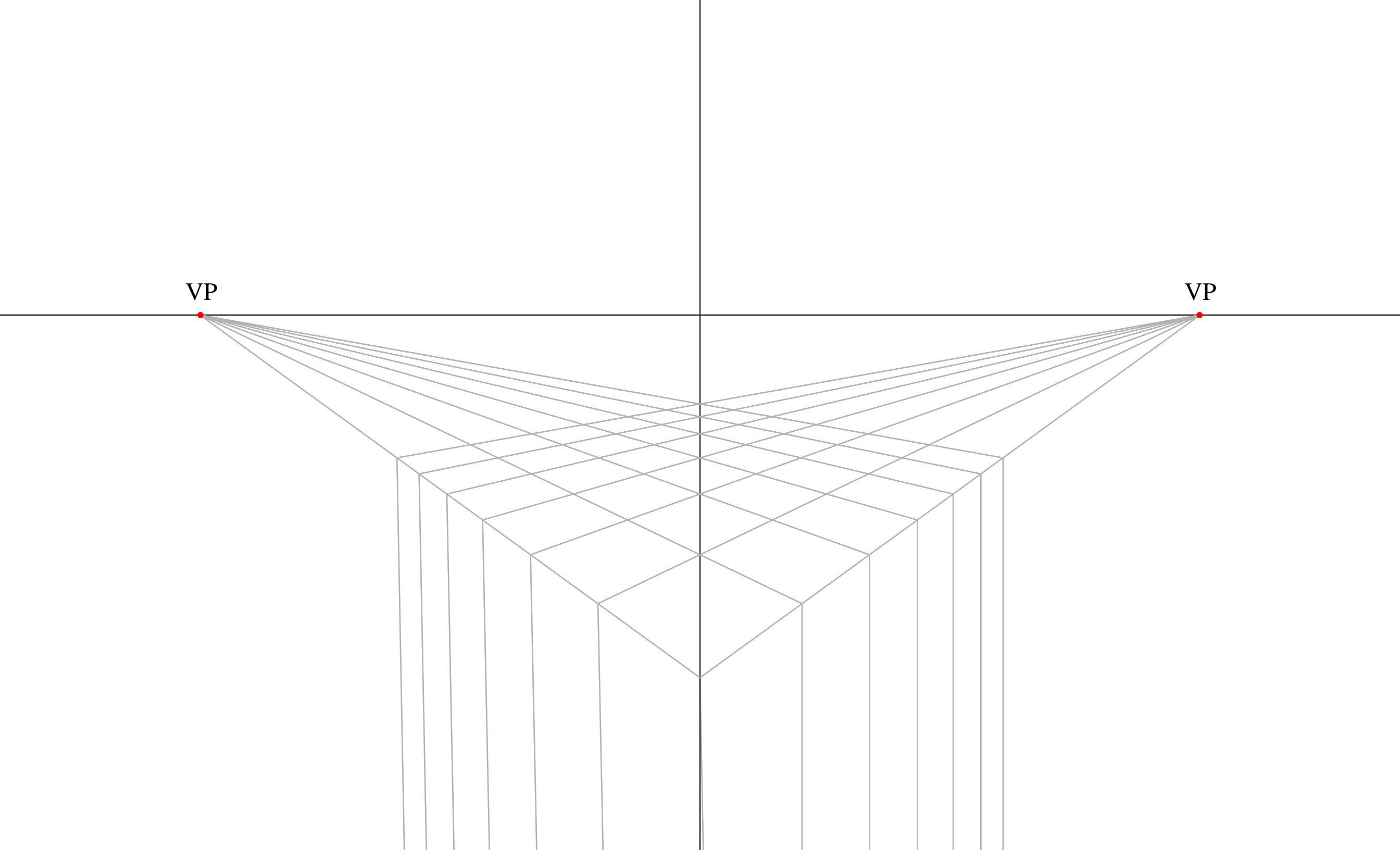

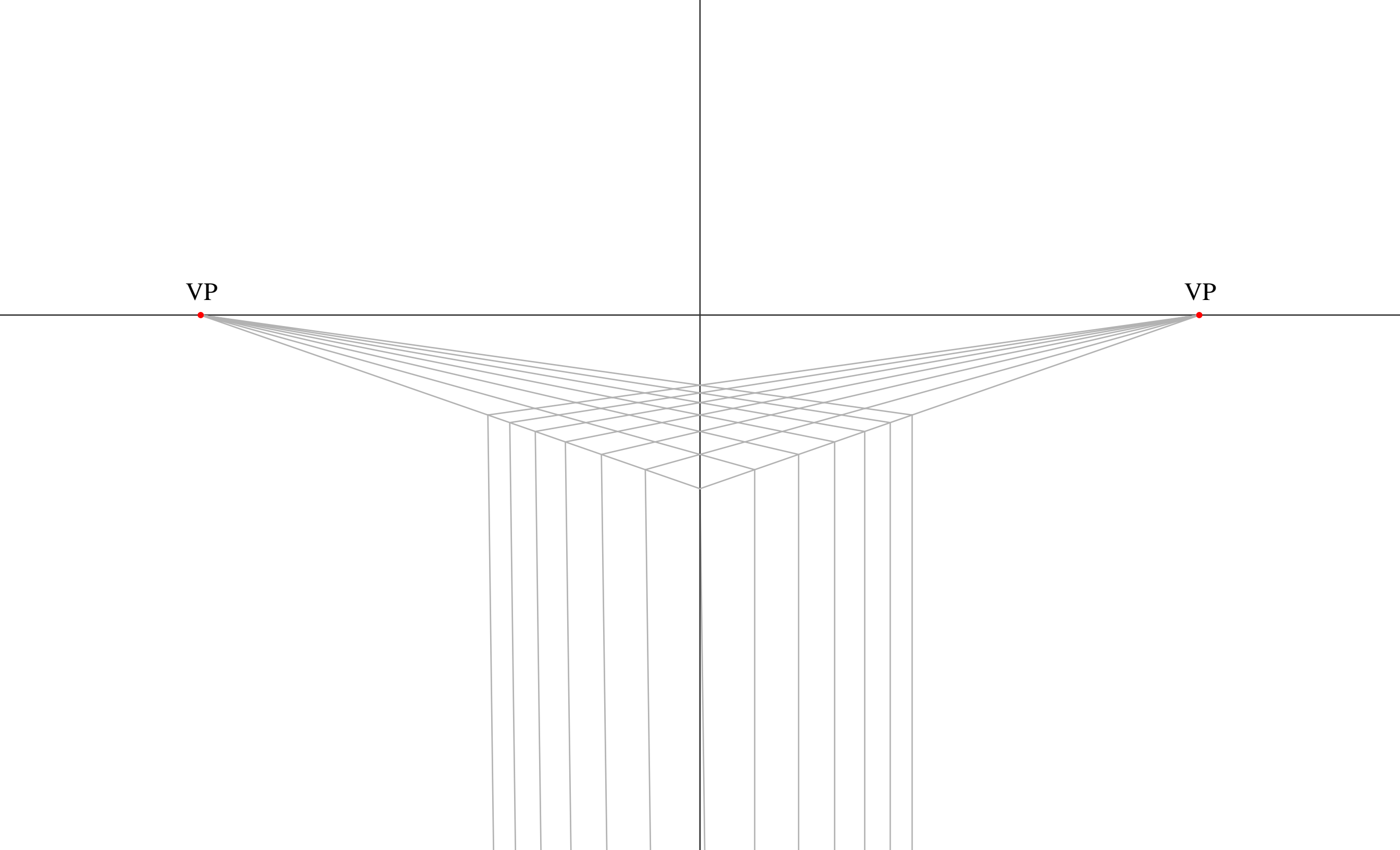

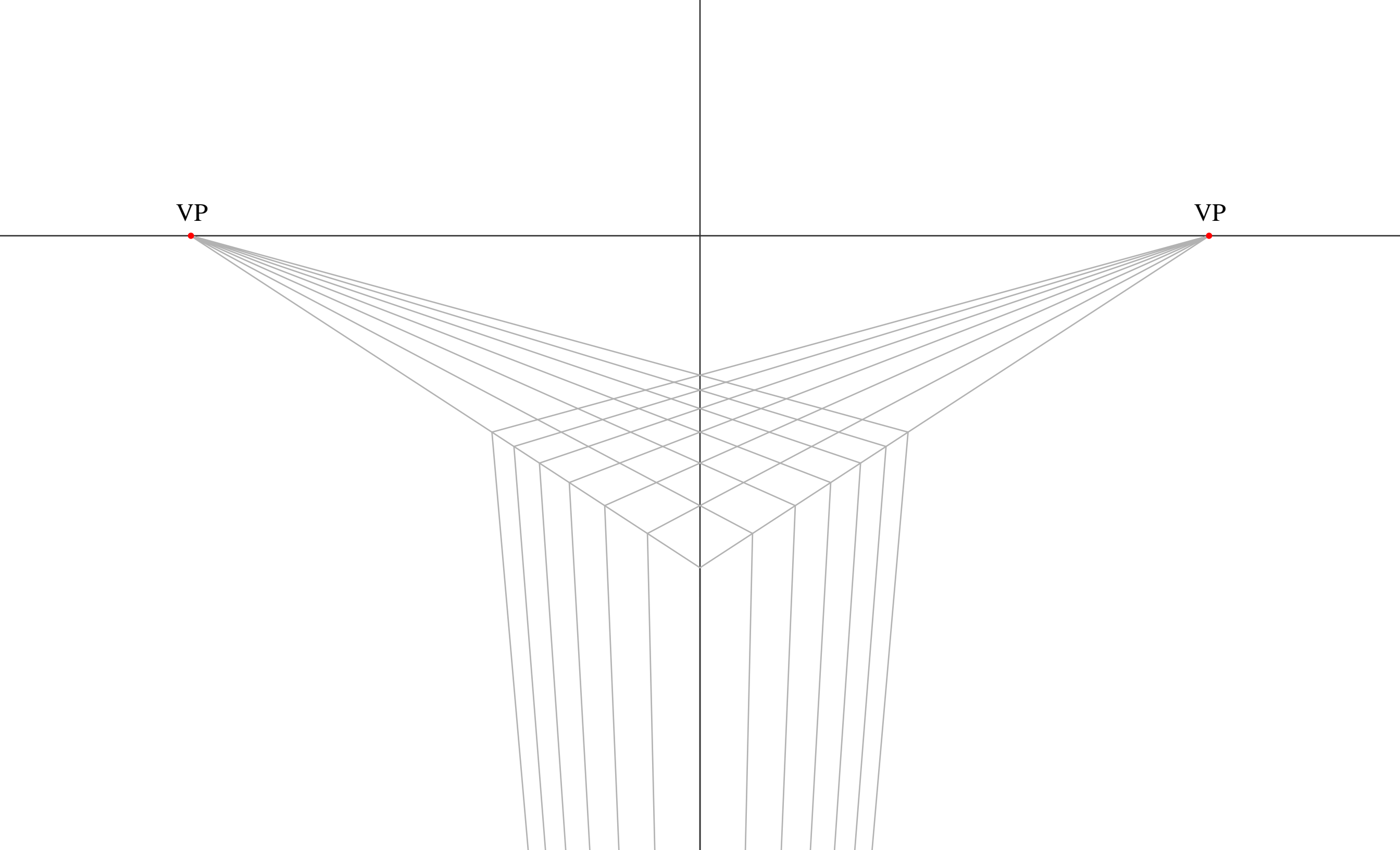

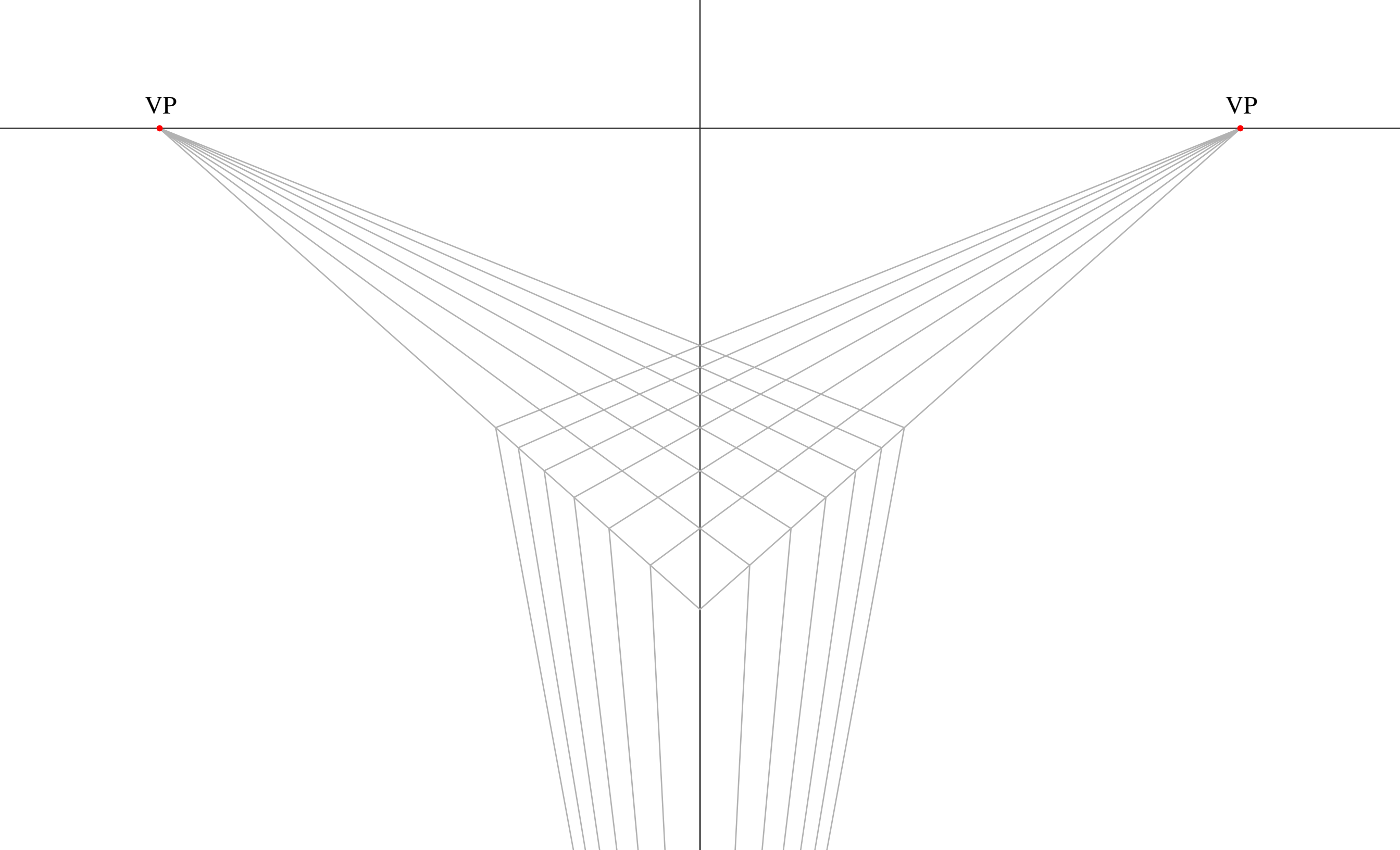

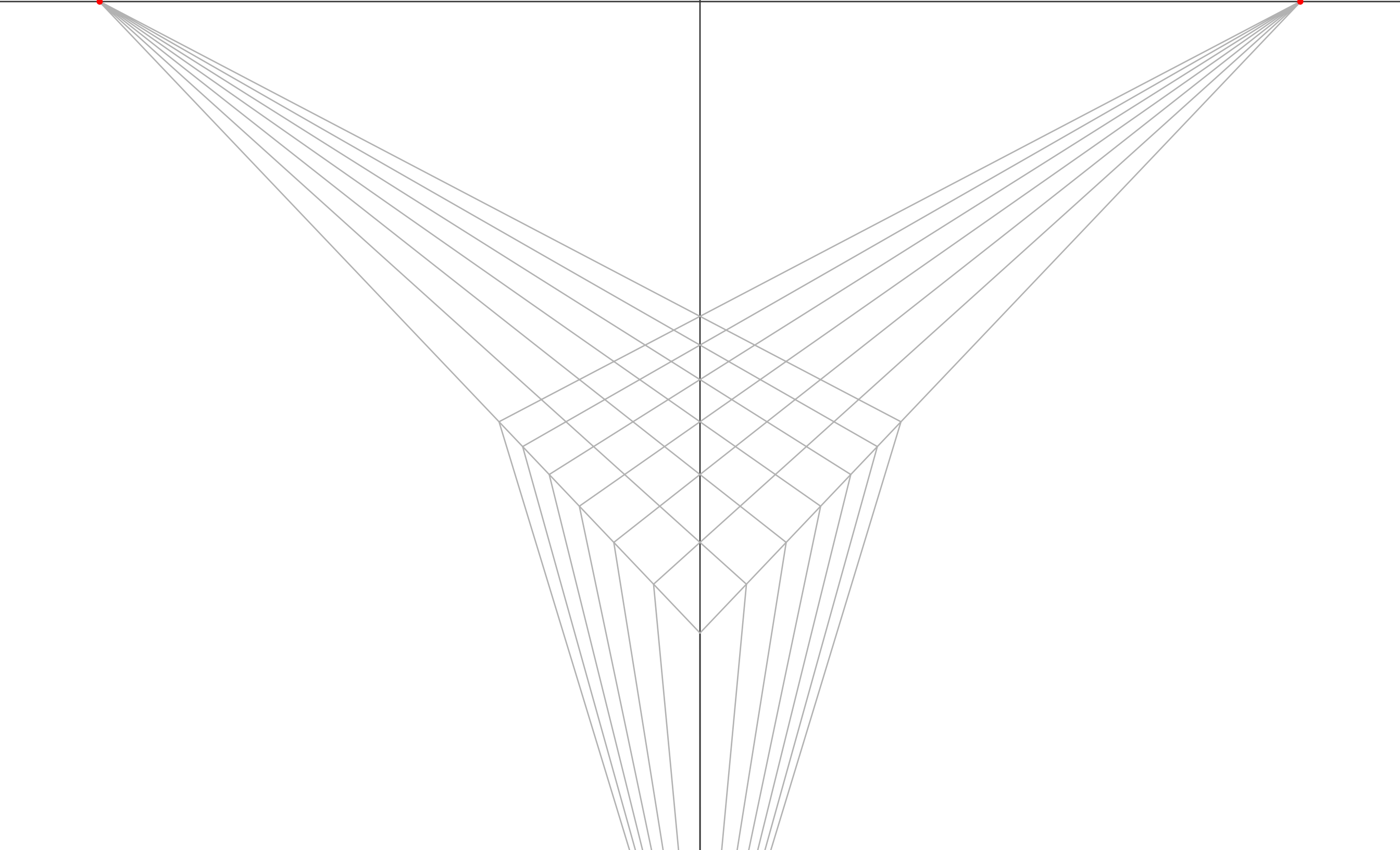

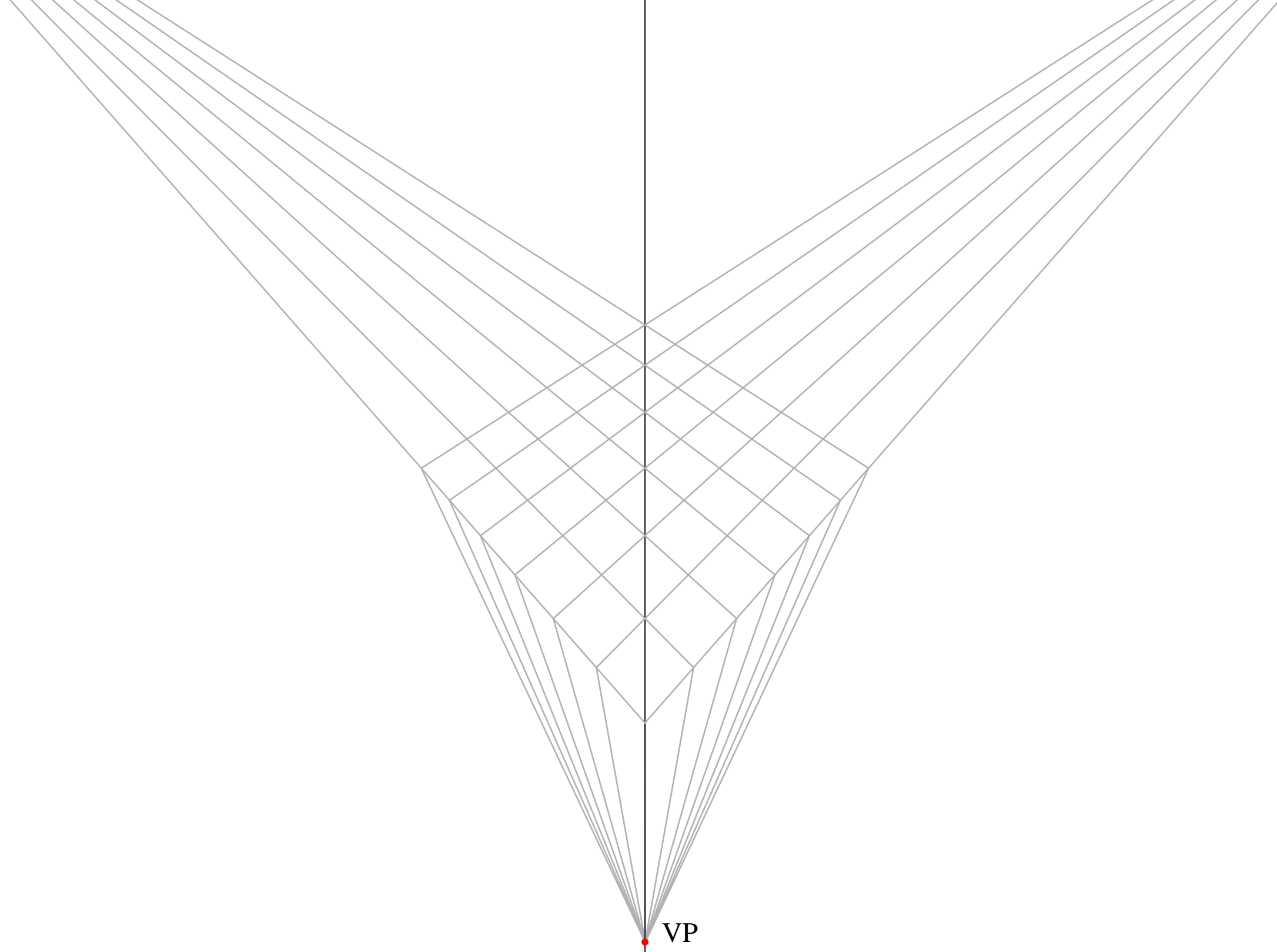

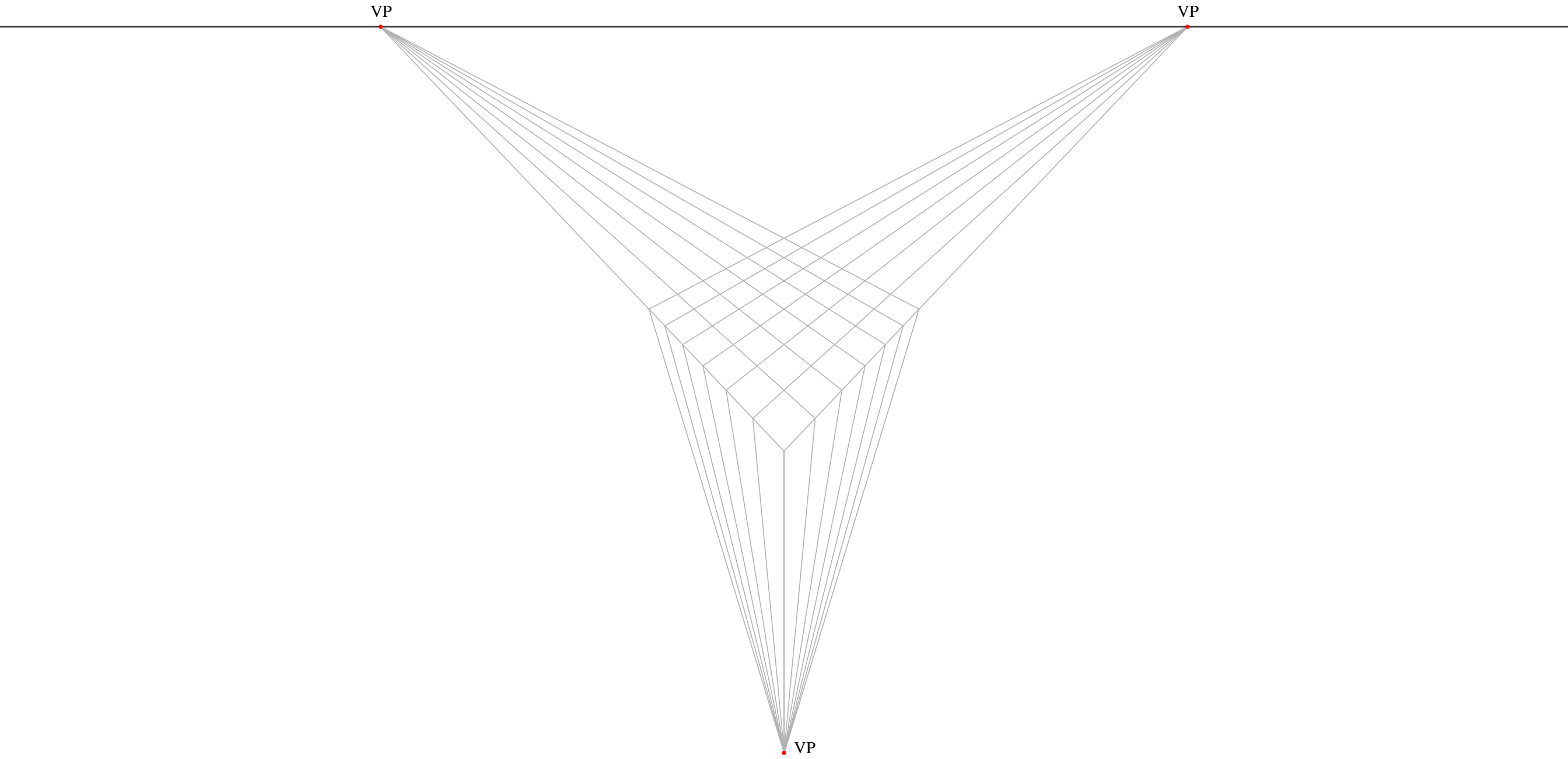

Three-point perspective:

All three axes now converge to vanishing points on the page. Usually, a drafter using three-point perspective would place all the vanishing points off the page, on a larger page behind the drawing so that the perspective does not seem unnatural.

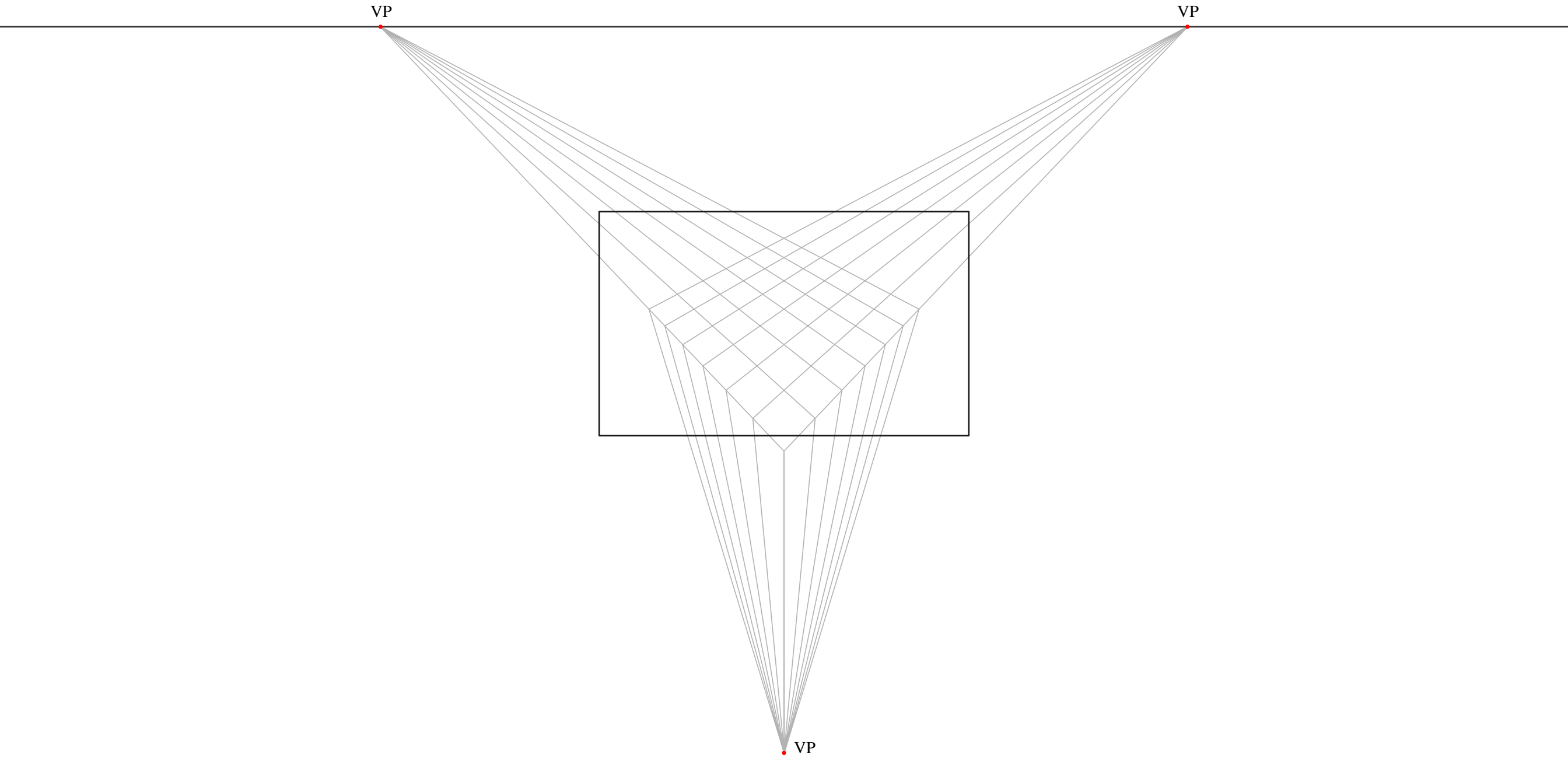

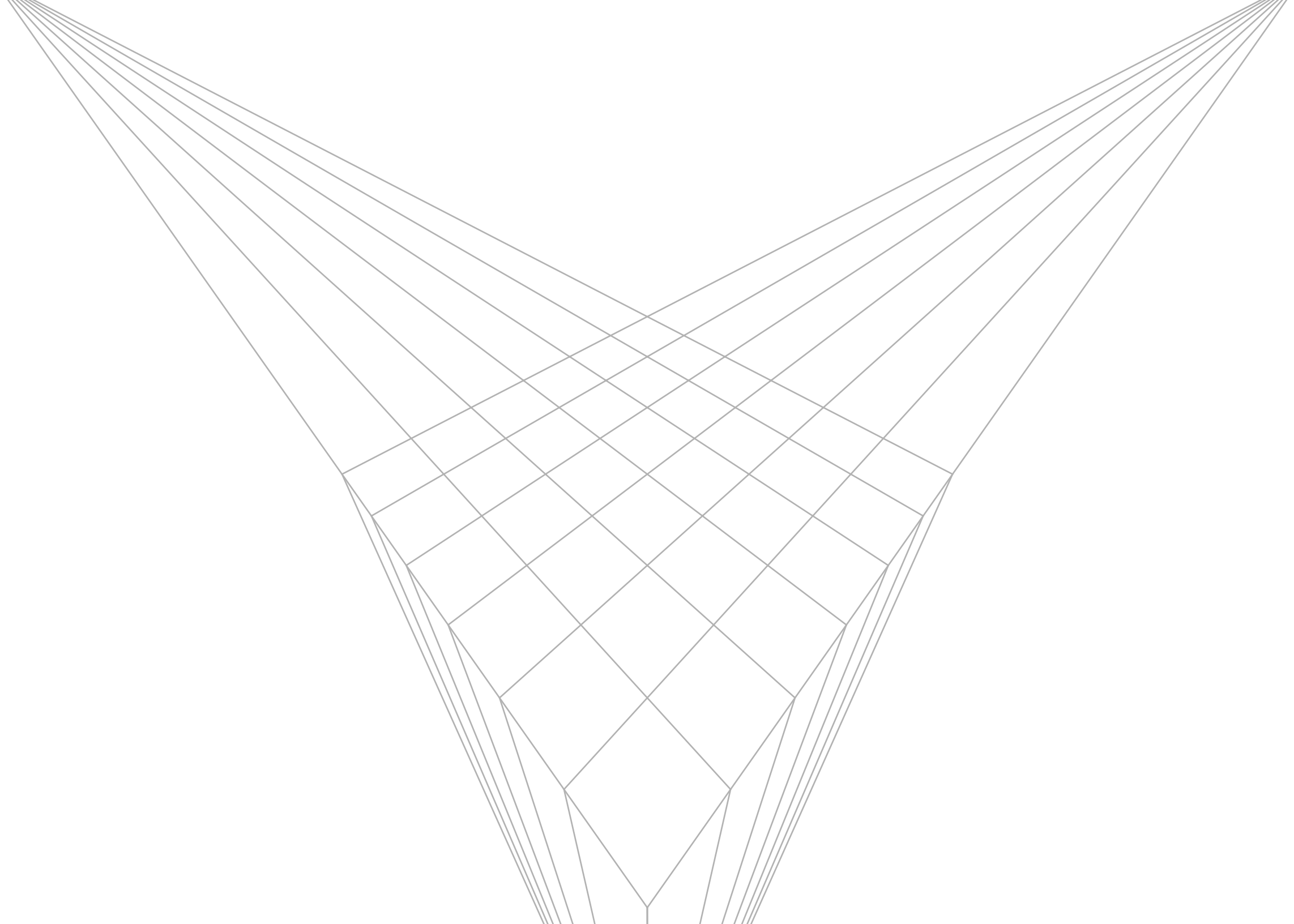

Drawing a Cube using three-point perspective:

There are no parallel lines or faces to the picture plane as there were in the first two cases. It is rather time consuming to draw using three point-perspective, but it is particularly usefull for drawing large-scale objects reletive to the viewer, either from a "birds-eye view" or a "mouse's view." Here is the birds-eye view...

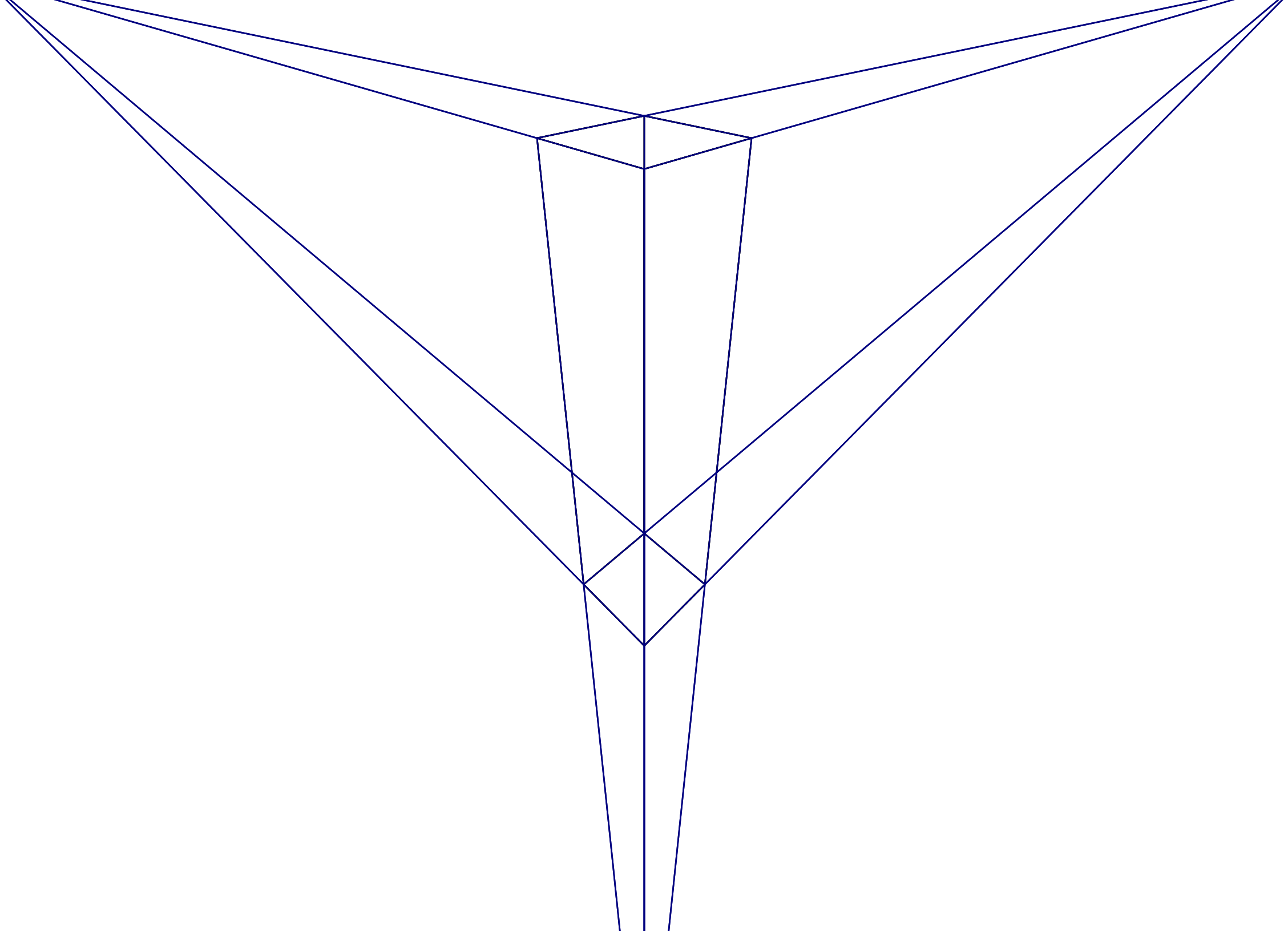

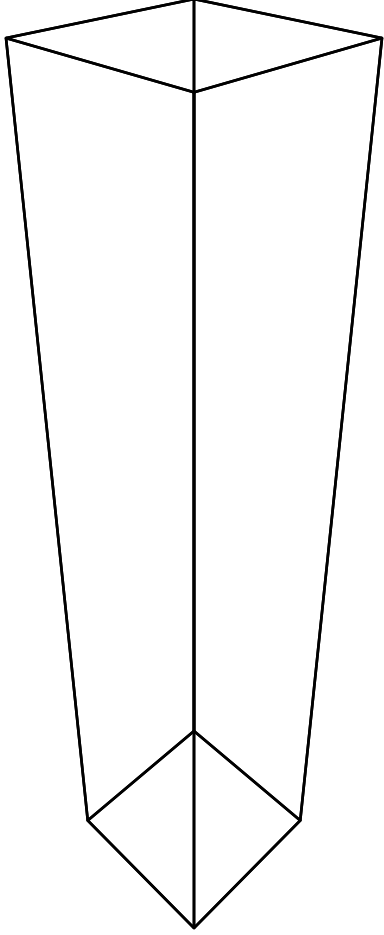

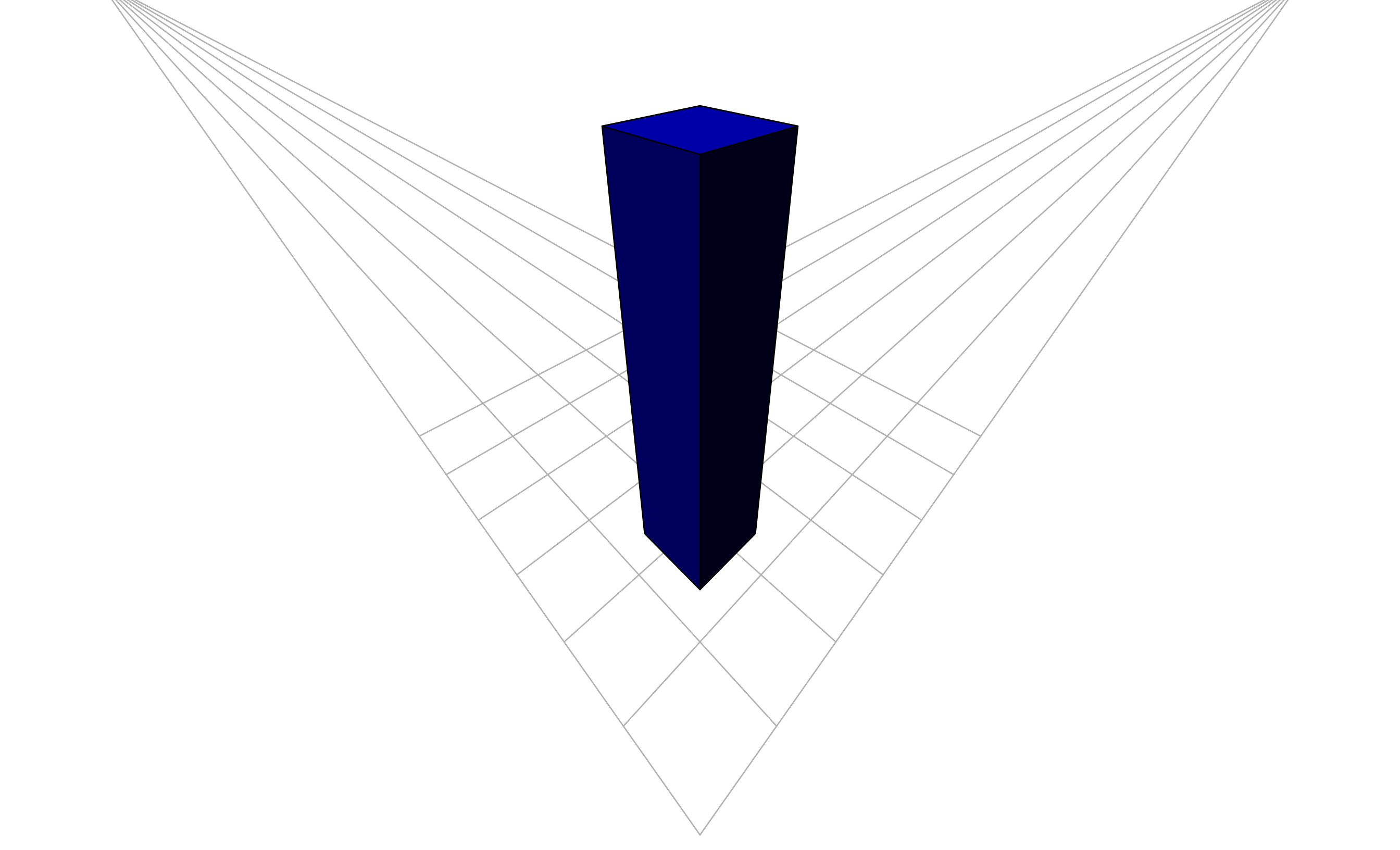

Here is the mouse's view...

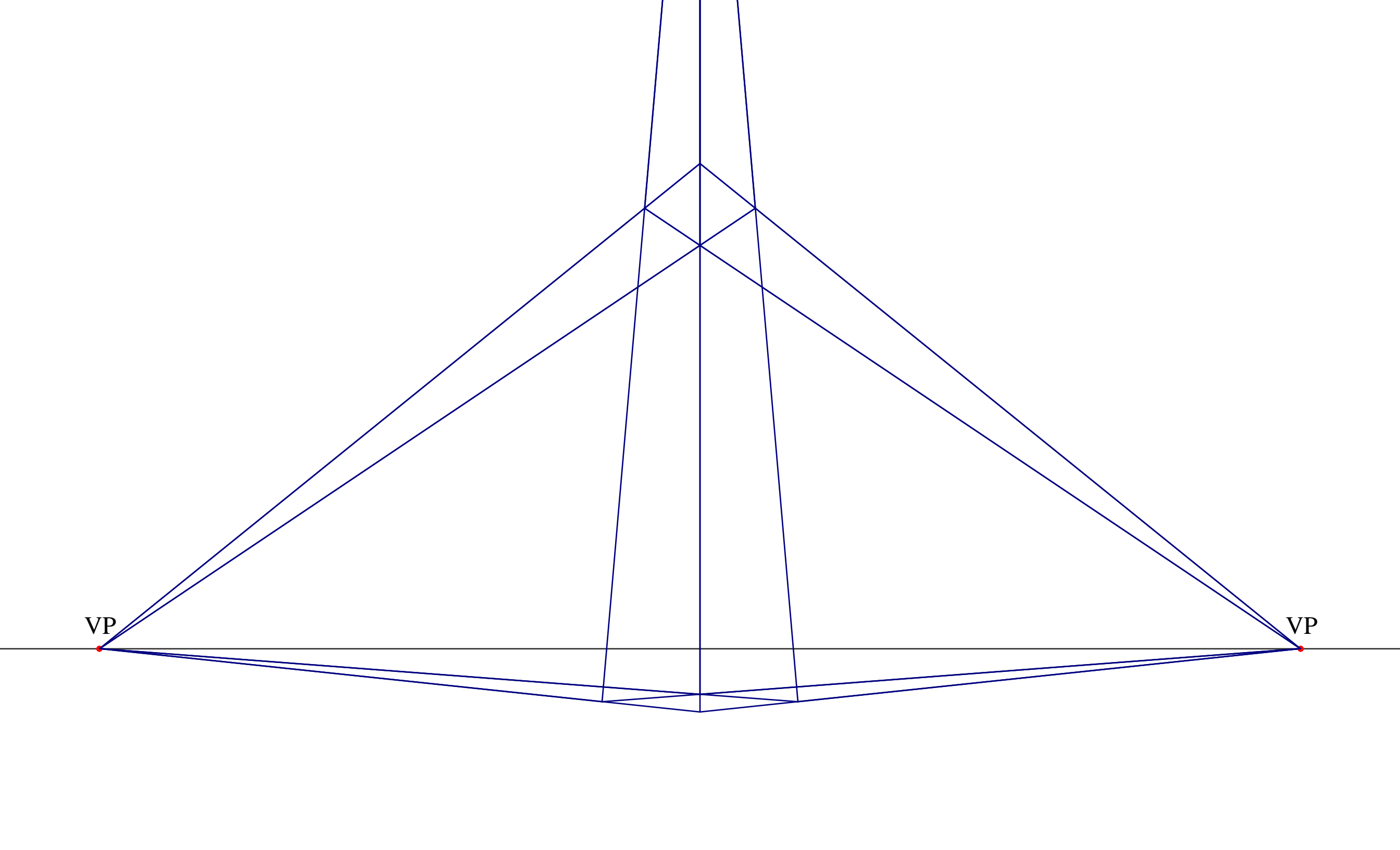

VP

VP

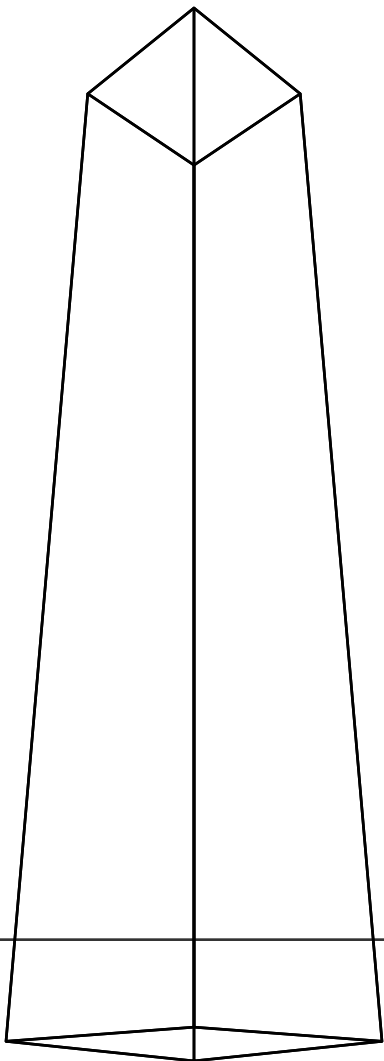

VP

VP

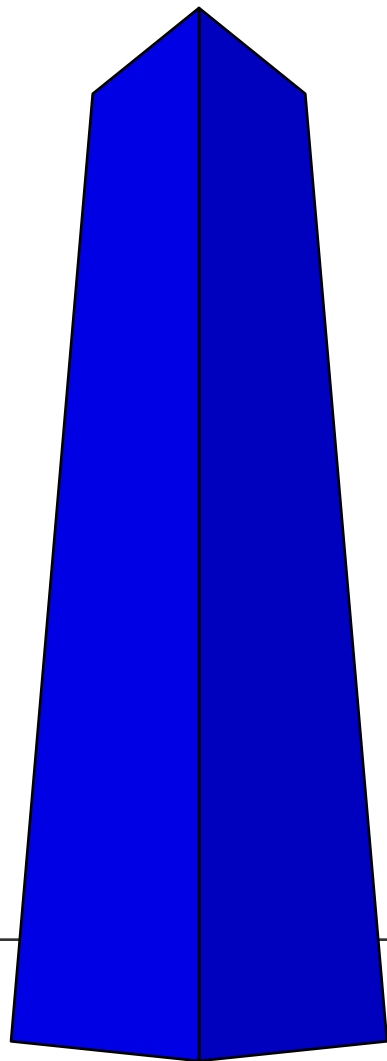

THE END.