

UBC Math 100: Differential Calculus

Textbook for AY 2024/25

This text is intended for UBC Math 100. It consists primarily of content drawn from three open-source textbooks:

- *CLP-1 Differential Calculus* by Joel Feldman, Andrew Rechnitzer, and Elyse Yeager
Copyright © 2016–24 CC-BY-NC-SA 4.0
- *Differential Calculus for the Life Sciences* by Leah Edelstein-Keshet
Copyright © 2020 CC-BY-NC-SA 4.0
- *Optimal, Integral, Likely* prepared by Bruno Belevan, Parham Hamidi, Nisha Malhotra, and Elyse Yeager
Copyright © 2020-21 CC-BY-NC-SA, which is itself largely based on
CLP-3 Multivariable Calculus by Joel Feldman, Andrew Rechnitzer, and Elyse Yeager
Copyright © 2016–2024 CC-BY-NC-SA 4.0

This document was typeset on Thursday 31st October, 2024.

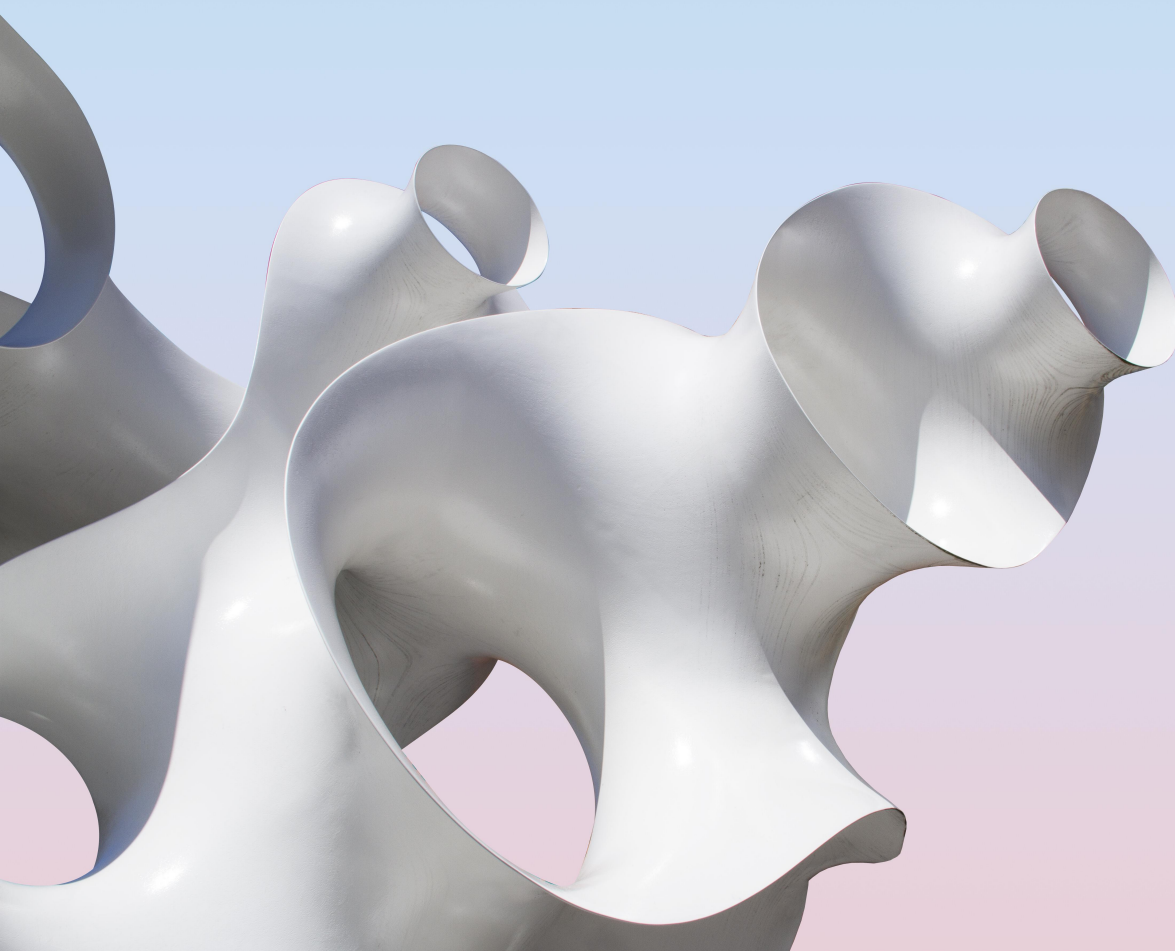

►► Licenses and attributions

Copyright ©2024 Kelly Paton, Elyse Yeager

Cover art: **Bulbous structure with shadows** by **Simone Hutsch** is reproduced with a **Royalty-Free Commercial License**. It is *not* creative commons.

Except where otherwise noted, this work is licensed under the Creative Commons Attribution-NonCommercial-ShareAlike 4.0 International License. You can view a copy of the license at <https://creativecommons.org/licenses/by-nc-sa/4.0/>.



The public-facing webpage for the project is <https://personal.math.ubc.ca/~elyse/Math100Text/>.

Source files can be found at the repository [on gitlab](#) (public version pending).

The creation of this resource was supported by a **UBC OER Grant**.

This text contains new material as well as material adapted from open sources.

- Chapter 0 is original content.
- Chapter 1 is adapted from Keshet, chapter 1.
- Chapter 2 is adapted from CLP and Keshet, with new content.
 - The introduction is adapted from Keshet Appendix D.
 - 2.1 is adapted from CLP section 1.3.
 - 2.1.1 is adapted from CLP section 1.4.
 - 2.1.2 is adapted from CLP section 1.5.
 - 2.2 is new content.
 - 2.3 is adapted from CLP section 1.6.
- Chapter 3 is adapted from CLP and Keshet, with new content.
 - Section 3.1 is new content.
 - Section 3.2 is adapted from Keshet Ch 2 and CLP 2.1, with new content .
 - Subsection 3.3.1 is adapted from CLP section 2.1.
 - Subsection 3.3.2 is adapted from CLP sections 2.1-2.3.
 - Section 3.4 is adapted from CLP section 2.14.
 - Section 3.5 is adapted from CLP section 2.7 and Keshet chapter 10.
- Chapter 4 is adapted from CLP
 - Section 4.1 is adapted from section 2.4.
 - The unnumbered section ”Proofs of the arithmetic of derivatives (starting on page 116) is adapted from section 1.9.

-
- The unnumbered section “Using the arithmetic of derivatives – examples” (starting page 118 in the textbook) is adapted from section 2.6.
 - Section 4.2 is adapted from section 2.8.
 - Section 4.3 is adapted from section 2.9.
 - Section 4.4 is adapted from section 2.10.
 - Section 4.5 is adapted from section 2.11.
 - Section 4.6 is adapted from sections 0.6 and 2.12.
 - The introduction to Chapter 4.7 is adapted from the introduction to chapter 3. The rest of section 4.7 is adapted from section 2.12.
- Chapter 5 is adapted from CLP section 3.2.
 - Chapter 6 is adapted from CLP section 3.7.
 - Chapter 7 is adapted from CLP section 3.6. (*Signs of factored functions* is new content.)
 - Chapter 8 is adapted from both CLP and Keshet.
 - The introduction and Sections 8.1, 8.2, and 8.3 are adapted from CLP section 3.5.
 - Section 8.4 is adapted from Keshet, chapter 7.
 - Chapter 9 is adapted from CLP section 3.4.
 - Chapter 10 is adapted from CLP appendix C.1.
 - Chapter 11 is adapted from Keshet chapter 11.
 - Chapter 12 is adapted from Keshet chapter 12.
 - Chapter 13 is adapted from Keshet Chapter 13.
 - Chapter 14 is adapted from OIL Chapter 1, which is itself based on CLP–3 Chapter 1; except subsection 14.1.1, which was Appendix A.1 in OIL, and does not appear in CLP–3.
 - Chapter 15 is adapted from OIL Sections 2.1-2.2, which are based on CLP–2 chapter 2.
 - Chapter 16 is adapted from OIL Sections 2.3-2.5, which are based on CLP–3 chapter 2.

CONTENTS

0	Introduction	1
0.1	About this book	1
0.1.1	Origins	1
0.1.2	Learning objectives	1
0.1.3	Flavours	2
0.1.4	Optional sections	2
0.2	Writing mathematics	2
	Pre-calculus	4
1	Power functions as building blocks	5
1.1	Power functions	5
1.2	First steps in graph sketching	9
1.3	Rate of reaction	14
1.4	(optional) Predator response	18
1.5	Familiar functions	21
2	Limits	27
2.1	Quick review of limits	27
2.1.1	Calculating limits with limit laws	37
2.1.2	Limits at infinity	47
2.2	Asymptotes	56
2.3	Limits and continuity	63
	Differentiation	69
3	Introduction to the Derivative	73
3.1	Review: lines	73
3.1.1	Equations and sketches	73
3.1.2	Different equation forms	75

3.1.3	Slopes at different points	78
3.2	Slopes and rates of change	79
3.2.1	Lines and rate of change	80
3.2.2	Nonlinear functions and average rates of change	82
3.3	The Derivative	85
3.3.1	Slope at a point	86
3.3.2	Definition of the derivative (1)	88
3.3.3	Tangent lines and linear approximations	91
3.3.4	Definition of the derivative (2)	94
3.3.5	Instantaneous rate of change	103
3.4	Higher order derivatives	105
3.5	Derivatives of exponential functions	107
4	Computing Derivatives	113
4.1	Arithmetic of derivatives	113
4.2	Trigonometric functions and their derivatives	128
4.3	The chain rule	137
4.4	Logarithmic differentiation	147
4.5	Implicit differentiation	154
4.6	Inverse functions	164
4.7	Inverse trig functions and their derivatives	169
	Applications of Differentiation	177
5	Related Rates	183
6	L'Hôpital's Rule and Indeterminate Forms	193
6.1	Standard examples	196
6.2	Variations	202
6.3	(optional) Even more variations	207
7	Sketching Graphs	213
7.1	Domain, intercepts and asymptotes	213
7.2	First derivative — increasing or decreasing	219
7.3	Second derivative — concavity	223
7.4	Symmetries	229
7.5	A checklist for sketching	237
7.6	Sketching examples	238
8	Optimization	249
8.1	Local and global maxima and minima	250
8.2	Finding global maxima and minima	258
8.3	Max/min examples	262
8.4	Sample optimization problems	280
8.4.1	Density dependent (logistic) growth in a population	280
8.4.2	Wine for Kepler's wedding	282
8.4.3	Optimal foraging	285

8.5	Summary	289
9	Approximating Functions Near a Specified Point— Taylor Polynomials	291
9.1	Zeroth approximation — the constant approximation	292
9.2	Linear approximation	294
9.3	Quadratic approximation	296
9.4	Still better approximations — Taylor polynomials	300
9.5	Some examples	302
9.6	(Flavour A) Error in Taylor Polynomials	308
9.7	(Optional) — Derivation of the error formulae	316
10	(Flavour A) Newton's Method	321
	Differential Equations	328
11	(Flavours A, B) Introduction to Differential Equations	331
11.1	Introducing a new kind of equation	331
11.2	Differential equation for unlimited population growth	335
11.3	Radioactive decay	342
11.4	Summary	346
12	(Flavours A, B) Solving differential equations	349
12.1	Verifying that a function is a solution	349
12.2	Equations of the form $y'(t) = a - by$	352
12.3	Euler's method and numerical solutions	362
12.4	Summary	368
13	(Flavours A, B) Qualitative methods for differential equations	371
13.1	Linear and nonlinear differential equations	371
13.2	The geometry of change	376
13.3	(Flavour B) State-space diagrams	380
13.4	Applying qualitative analysis to biological models	386
13.5	Summary	395
	Application to Multivariable Functions	397
14	(Flavour C) Geometry in Three Dimensions	399
14.1	Points and planes	399
14.1.1	(optional) Folding the first octant of \mathbb{R}^3	402
14.2	Functions of two variables	403
14.3	Sketching surfaces in 3D	409
15	(Flavour C) Partial Derivatives	429
15.1	Partial derivatives	429
15.2	Higher order derivatives	437

16 (Flavour C) Optimization of Multivariable Functions	441
16.1 Local maximum and minimum values	441
16.1.1 Critical points	442
16.1.2 Classifying critical points	452
16.2 Absolute minima and maxima	462
16.3 Lagrange multipliers	471
16.3.1 Motivation for the method	472
16.3.2 Using the method	474
16.3.3 Bounded vs unbounded Constraints	483
A List of learning objectives	489

INTRODUCTION

Welcome to UBC Math 100, Differential Calculus.

0.1 ▲ About this book

0.1.1 ►► Origins

In previous years, Math 100 students were directed to different chapters in three different books. This document is, more-or-less, the relevant parts of those three texts stapled together, with some added content where needed.

You may notice differences from section to section in formatting and tone. In the practice book, some questions have solutions, and some do not, due to the different source materials for the questions. In particular, textbooks that do not contain solutions generally do so for pedagogical reasons; if we were to publish solutions to their questions here, it would compromise the integrity of their work.

We are making efforts to ensure that the content here matches the Math 100 learning goals exactly, but it is a work in progress.

0.1.2 ►► Learning objectives

The learning objectives for the class are included in this text, in grey boxes. Generally, these are printed at the start of a subsection. You can also see a printout of objectives for the entire course in the [Appendix A](#).

There are some overarching learning objectives for this course that are not tied to any particular section. These are given below.

Learning Objectives

- Solve a long question by breaking it up into smaller pieces.
- Apply mathematical concepts to models of physical processes.
- Apply concepts creatively to unfamiliar contexts.

- Be able to clearly and effectively communicate mathematical content in prose.
- Understand some basic ideas about what constitutes a proof in mathematics; understand the differences between how something is defined and how it is computed.
- Correctly and appropriately manipulate algebraic and trigonometric expressions: simplification, solving, etc.

Learning objectives can also help you distinguish between key ideas and examples of key ideas. If you see a long applied example about (say) cell structure, you might wonder how much of it is assessable, and how much of it is an example of using assessable material. The learning objectives can help you distinguish.

0.1.3 ►► Flavours

Math 100 has three flavours. All of them use this document. Some content is shared between all flavours, and some is not.

Content that isn't shared by all flavours is marked. For example, Chapter 14 has “Flavour C” in its title, and a coloured bar running along the left margin. If you're in Flavour C, this content will be covered in class and homework, and is examinable. If you're in flavours A or B, this chapter won't show up in class or on exams. You may wish to self-study content from other flavours (especially smaller pieces of content, like a single example) for personal interest, or to deepen your familiarity with common concepts, but doing so is purely optional.

Sometimes content looks a lot like one flavour (for example, an exercise about finding interest on an investment would look like Flavour C) but uses mathematics common to all flavours. These are generally not marked as flavoured, since the content may be helpful for all flavours.

0.1.4 ►► Optional sections

We've made an effort for this book to match the Math 100 syllabus as closely as possible, with exceptions clearly labelled. Unless otherwise announced in class, sections marked 'optional' are not assessable. They may include ideas that are interesting in their own right; they may also include examples of using assessable material. So, while studying them may help you study for the class, learning their precise content is optional.

0.2 ▲ Writing mathematics

Writing answers to questions in mathematics is much less about simply getting the correct result somewhere on the page, and much more about communicating *how* you arrived at that result. As in any discipline, the type of communication required will vary depending on the circumstances. Think about the difference between writing yourself jot notes in English class, versus writing a formal English essay. Both types of writing need to make sense, but they have different expectations in terms of style, presentation, and level of detail.

If you are writing *informally* (e.g., solving an exam question under time pressure, or solving a problem on a worksheet), your written mathematics should follow these basic guidelines:

- Use the symbols given in the problem statement (e.g., x). If you need to introduce a new symbol, clearly define it (e.g., “let y = length of desk”, or label it on a diagram).
- Make sure your statements are unambiguous. In general, the standalone fragment “= 5” is incomplete and unclear (what is it that “equals five”?), but “ $x = 5$ ” is a complete mathematical statement (as long as your reader knows what x represents).
- Be particularly careful with ambiguity and clarity when doing multi-line calculations. For instance, although it is reasonable to not repeat the left-hand side of an equality if it remains the same line by line, e.g.

$$\begin{aligned} f(x) &= (x + 5)(x - 2) \\ &= x^2 + 3x - 10, \end{aligned}$$

ensure you do not neglect the left-hand side if it changes:

$$\begin{aligned} f(x) &= (x + 5)(x - 2) \\ &= x^2 + 3x - 10 \\ 2f(x) &= 2x^2 + 6x - 20. \end{aligned}$$

- Use English words to explain any reasoning that is not captured by your mathematical notation.
- If you perform multiple different calculations within one solution, label them (e.g., “finding critical pts”, “finding minimum”).
- If you make any assumptions, state them.

If you are writing a solution more *formally*, such as for a written assignment, then you should follow the above guidelines, and additionally:

- Explain what you are doing *at each step*. For instance, are you taking a derivative of a function $f(x)$? Write it: “Taking the derivative of $f(x)$ reveals $f'(x) = \dots$ ”.
- Be clear. Instead of “It is nonzero because...”, write “*The function* is nonzero because...”.
- Use appropriate spelling, grammar, and punctuation – including ending sentences with a period – even when you are using mathematical notation. Although “ $x = 5$ ” might suffice on an exam, on an assignment you would write something like “We get $x = 5$.”, complete with period.
- Format your mathematics appropriately. For instance, the exponential function should look like e^x : italicized, with the x as a superscript. In LaTeX, this would be typed in math mode as “ $\$e \wedge x\$$.” In Word or Google Docs, you can use the equation editor, or manually format the expression in italics and superscript the x .
- Ensure your entire solution is readable from start to finish, like a paragraph or an essay (instead of like jot notes, which would suffice for an *informal* solution). You can test this by reading the entire solution out loud to someone (even yourself). A readable solution almost always requires including additional English sentences to explain what you are doing, and it often involves enclosing your mathematical equations within English sentences.

Following these guidelines, one way to more formally write the informal calculation shown above is: “Consider the function $f(x) = (x + 5)(x - 2)$, which expands to $f(x) = x^2 + 3x - 10$. We multiply f by 2 to get $2f(x) = 2x^2 + 6x - 20$.” There are of course many ways to write this formally; this is just an example. Many solutions in this textbook choose to present solutions as an indented chunk of properly-formatted equations surrounded by English sentences; for instance:

“ Consider the function

$$\begin{aligned} f(x) &= (x + 5)(x - 2) \\ &= x^2 + 3x - 10. \end{aligned} \qquad \text{(expanded)}$$

Multiply by two to get:

$$2f(x) = 2x^2 + 6x - 20. \qquad \text{”}$$

POWER FUNCTIONS AS BUILDING BLOCKS

Like tall architectural marvels that are made of simple units (beams, bricks, and tiles), many interesting functions can be constructed from simpler building blocks. In this chapter, we study a family of simple functions, the power functions — those of the form $f(x) = x^n$.

Our first task is to understand properties of the members of this “family”. We will see that basic observations of power functions such as x^2, x^3 lead to insights into significant considerations such as the sustainability of life on planet Earth (for example). Later, we use power functions as “building blocks” to construct polynomials and rational functions¹. We then develop important approaches to sketch the shapes of the resulting graphs.

1.1 ▲ Power functions

Learning Objectives

- Sketch functions of the form $f(x) = x^n$, where n is a real number (power functions); interpret the shapes of power functions relative to one another.
- Determine which term in a polynomial function will dominate for small x and for large x .

Let us consider the power functions, that is, functions of the form

$$y = f(x) = x^n,$$

where n is a real number. Power functions are among the most elementary and “elegant” functions - we only need multiplications to compute their value at any point. They are thus easy to calculate, very predictable and smooth, and, from the point of view of calculus, very easy to handle.

1 Now would be a good time to check in with your understanding of these terms. Can you define *function*? Can you give an example of a polynomial function? What about an example of a rational function?

 Click on this link and then adjust the slider on this interactive **desmos** graph to see how the power n affects the shape of a power function in the first quadrant.

From Figure 1.1, we see that the power functions ($y = x^n$ for powers $n = 2, \dots, 5$) intersect² at $x = 0$ and $x = 1$. This is true for all positive integer powers. The same figure also demonstrates another fact helpful for curve-sketching: the greater the power n , the *flatter* the graph near the origin and the *steeper* the graph beyond $x > 1$. This can be restated in terms of the relative size of the power functions. We say that *close to the origin, the functions with lower powers dominate, while far from the origin, the higher powers dominate*.

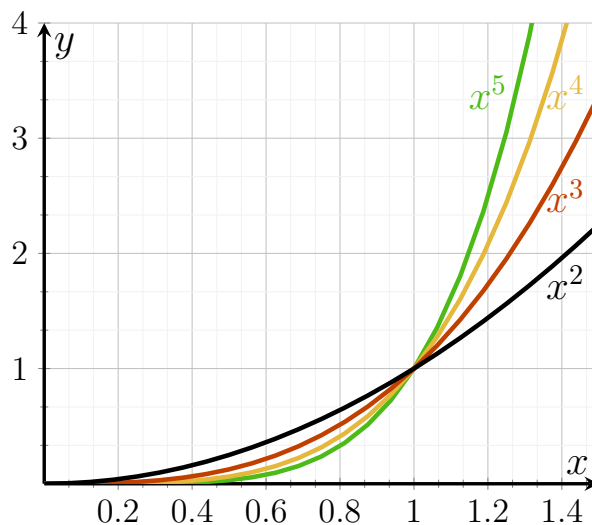

Figure 1.1: Graphs of a few power functions $y = x^n$. All intersect at $x = 0, 1$. As the power n increases, the graphs become flatter close to the origin, $(0, 0)$, and steeper at large x -values.

More generally, a power function has the form

$$y = f(x) = K \cdot x^n$$

where n is a real number and K , sometimes called the **coefficient**, is a constant.

So far, we have compared power functions whose coefficient is $K = 1$. We can extend our discussion to a more general case as well.

Example 1.1.1

Find points of intersection and compare the sizes of the two power functions

$$y_1 = ax^n, \quad \text{and} \quad y_2 = bx^m.$$

where a and b are constants. You may assume that both a and b are positive.

This comparison is a slight generalization of the previous discussion. First, we note that the coefficients a and b merely scale the vertical behaviour (i.e. stretch the graph along the y axis). It is still true that the two functions intersect at $x = 0$; further, as before, the higher the power, the flatter the graph close to $x = 0$, and the steeper for large positive or negative values of x . However, now another point of intersection of the graphs occur when

$$ax^n = bx^m \quad \Rightarrow \quad x^{n-m} = (b/a).$$

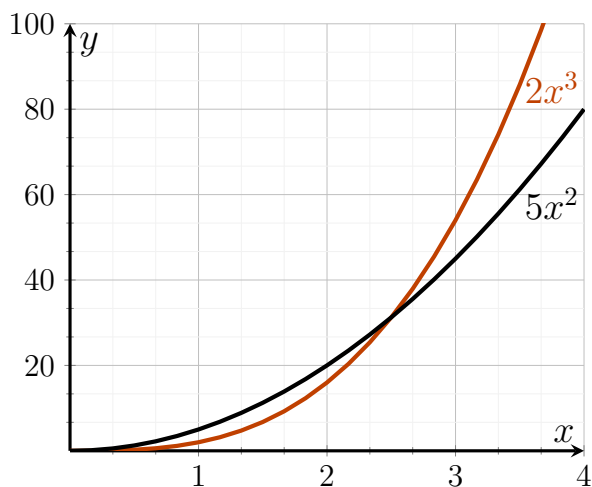

Figure 1.2: Graphs of two power functions, $y = 5x^2$ and $y = 2x^3$.

We can solve this further to obtain a solution in the first quadrant³:

$$x = (b/a)^{1/(n-m)}. \quad (1.1.1)$$

This is shown in Figure 1.2 for the specific example of $y_1 = 5x^2, y_2 = 2x^3$. Close to the origin, the quadratic power function has a larger value, whereas for large x , the cubic function has larger values. The functions intersect when $5x^2 = 2x^3$, which holds for $x = 0$ or $x = \frac{5}{2} = 2.5$. \diamond

If b/a is positive, then in general the value given in (1.1.1) is a real number.

Example 1.1.1

Example 1.1.2

Determine points of intersection for the following pairs of functions:

- (a) $y_1 = 3x^4$ and $y_2 = 27x^2$,
- (b) $y_1 = \left(\frac{4}{3}\right)\pi x^3$ and $y_2 = 4\pi x^2$.

Following the steps outlined above in Example 1.1.1 (calculations not shown in detail here — this is a good place for you to try the calculations yourself), we find the following intersections:

- (a) Intersections occur at $x = 0$ and at $\pm(27/3)^{1/(4-2)} = \pm\sqrt{9} = \pm 3$.
- (b) These functions intersect at $x = 0, 3$ but there are no other intersections at negative values of x .

Example 1.1.2

- 2 How comfortable are you with interpreting graphs? Check in: use Figure 1.1 to approximate when $x^5 = 2$.
- 3 Another good check-in point: If asked to draw a solution in the first quadrant, you should know that this means the upper right-hand corner of the graph, which is where both x and y are positive.

Note that in many cases, the points of intersection are irrational numbers⁴ whose decimal approximations can only be obtained by a scientific calculator or by some approximation method (such as Newton's Method, studied in Chapter 10).

With only these observations we can examine the issue of energy balance and the sustainability of life on Earth — as seen next.

►► Sustainability and energy balance on Earth

The sustainability of life on planet Earth depends on a fine balance between the temperature of its oceans and land masses and the ability of life forms to tolerate climate change. We introduce a simple energy balance model to track incoming and outgoing energy and determine a rough estimate for the Earth's temperature. We use the following basic assumptions:

1. Energy input from the sun, given the Earth's radius r , can be approximated as⁵

$$E_{in} = (1 - a)S\pi r^2, \quad (1.1.2)$$

where S is incoming radiation energy per unit area (also called the **solar constant**), and $0 \leq a \leq 1$ is the fraction of that energy reflected; a is also called the **albedo**, and depends on cloud cover, and other planet characteristics (such as percent forest, snow, desert, and ocean).

2. Energy lost from Earth due to radiation into space depends on the current temperature of the Earth T , and is approximated as

$$E_{out} = 4\pi r^2 \varepsilon \sigma T^4, \quad (1.1.3)$$

where ε is the **emissivity** of the Earth's atmosphere, which represents the Earth's tendency to emit radiation energy. This constant depends on cloud cover, water vapour, as well as on **greenhouse gas** concentration in the atmosphere; σ is a physical constant (the Stephan-Boltzmann constant) which is fixed for the purpose of our discussion.

Notice there are several different symbols in Eqns. (1.1.2) and (1.1.3). Being clear about which are constants and which are variables is critical to using any mathematical model. As the next example points out, sometimes you have a choice to make.

Example 1.1.3 (Energy expressions are power functions)

Explain in what sense the two forms of energy above can be viewed as power functions, and what types of power functions they represent.

Both E_{in} and E_{out} depend on Earth's radius as the power $\sim r^2$. However, since this radius is a constant, it is not fruitful to consider it as an interesting variable for this problem. However, we note that E_{out} depends on temperature as $\sim T^4$. (We might also select the albedo as a variable and in that case, we note that E_{in} depends linearly on the albedo a .)

4 As a reminder, an irrational number is a real number that cannot be expressed as a ratio of integers. Classic examples are $\sqrt{2}$ and π .

5 Take a close look at the formula for E_{in} in equation 1.1.2. Do you think E_{in} is proportional to Earth's surface area, or its volume? If you're stuck, consider the formulas for the surface area and the volume of a sphere.

Example 1.1.3

Example 1.1.4 (Energy equilibrium for the Earth)

Explain how the assumptions above can be used to determine the equilibrium temperature of the Earth, that is, the temperature at which the incoming and outgoing radiation energies are balanced.

The Earth is at equilibrium when

$$E_{in} = E_{out} \quad \Rightarrow \quad (1 - a)S\pi r^2 = 4\pi r^2 \epsilon \sigma T^4.$$

We observe that the factors πr^2 cancel, and we can obtain an equation that can be solved for the temperature T ...

... this is left for you (the reader) to finish! Once you have the answer ($T = \dots$) it is additionally instructive to examine how this temperature depends on the constants in the problem, and how it is affected by cloud cover and greenhouse gas level.

Example 1.1.4

1.2 ▲ First steps in graph sketching

Learning Objectives

- Sketch two-term polynomial functions by determining which term dominates for small x and for large x . For example, sketch $f(x) = x^2 - 3x^4$.

►► Even and odd power functions

So far, we have considered power functions $y = x^n$ with $x > 0$. But in mathematical generality, there is no reason to restrict the independent variable x to positive values. Thus we expand the discussion to consider all real values of x . We examine now some symmetry properties that arise.

In Figure 1.3 (a) we see that power functions with an even power, such as $y = x^2$, $y = x^4$, and $y = x^6$, are symmetric about the y -axis. In Figure 1.3(b) we notice that power functions with an odd power, such as $y = x$, $y = x^3$ and $y = x^5$ are symmetric when rotated 180° about the origin. We adopt the term **even function** and **odd function** to describe such symmetry properties. More formally,

$$\begin{aligned} f(-x) = f(x) &\quad \Rightarrow \quad f \text{ is an even function,} \\ f(-x) = -f(x) &\quad \Rightarrow \quad f \text{ is an odd function} \end{aligned}$$

Many functions are not symmetric at all, and are neither even nor odd.

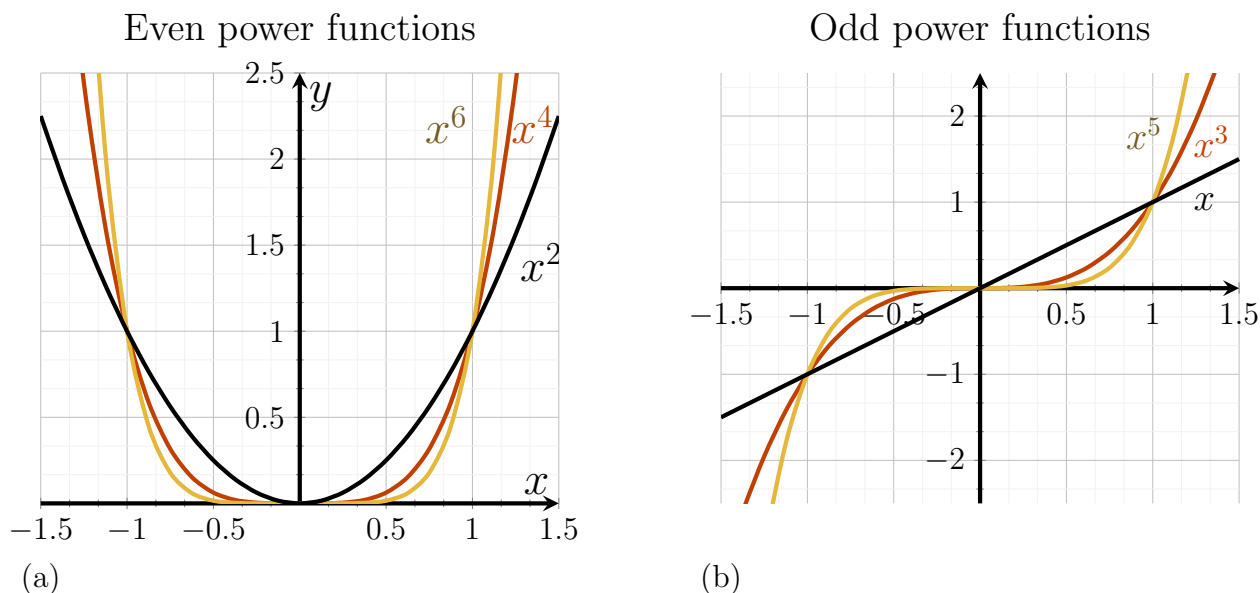



Figure 1.3: Graphs of power functions. (a) A few even power functions: $y = x^2$, $y = x^4$ and $y = x^6$. (b) Some odd power functions: $y = x$, $y = x^3$ and $y = x^5$. Note the symmetry properties.

 Adjust the slider to see how the even and odd power functions behave as their power increases.

Example 1.2.1

Show that the function $y = g(x) = x^2 - 3x^4$ is an even function

For g to be an even function, it should satisfy $g(-x) = g(x)$. Let us calculate $g(-x)$ and see if this requirement holds. We find that

$$g(-x) = (-x)^2 - 3(-x)^4 = x^2 - 3x^4 = g(x).$$

Here we have used the fact that $(-x)^n = (-1)^n x^n$, and that when n is even, $(-1)^n = 1$.

Example 1.2.1

All power functions are continuous and **unbounded**: for $x \rightarrow \infty$ both even and odd power functions satisfy $y = x^n \rightarrow \infty$. For $x \rightarrow -\infty$, odd power functions tend to $-\infty$. Odd power functions are **one-to-one**: that is, each value of y is obtained from a unique value of x and vice versa. This is not true for even power functions. From Fig 1.3 we see that all power functions go through the point $(0,0)$. Even power functions have a local minimum at the origin whereas odd power functions do not.

Definition 1.2.2 (Local Minimum).

A local minimum of a function $f(x)$ is a point x_{min} such that the value of f is larger at all sufficiently close points.

(We'll revisit this idea later in the course. See Definition 8.1.2 for more detail.)

Concept Check-In

(Grey boxes labelled “Concept Check-In” — containing questions or prompts that encourage you to check in on your knowledge or comfort with concepts — like this one, are offered occasionally in select chapters.)

1. Highlight the y -axes and circle the origins in Fig 1.3.
2. Consider Figure 1.3: where do even power functions intersect? Odd?
3. Show that $f(a) = a^5 - 3a$ is an odd function.
4. Give an example of a function which is **bounded**.
5. Verify $y = x^2$ is **not** one-to-one.
6. What graphical property do one-to-one functions share?

►► Sketching a simple (two-term) polynomial

Based on our familiarity with power functions, we now discuss functions made up of such components. In particular, we extend the discussion to **polynomials** (sums of power functions) and **rational functions** (ratios of such functions). We also develop skills in sketching graphs of these functions.

Example 1.2.3 (Sketching a simple cubic polynomial)

Sketch a graph of the polynomial

$$y = p(x) = x^3 + ax. \quad (1.2.1)$$

How would the sketch change if the constant a changes from positive to negative?

 Adjust the slider to see how positive and negative values of the coefficient a affect the shape of this simple polynomial.

The polynomial in Eqn. (1.2.1) has two terms, each one a power function. Let us consider their effects individually. Near the origin, for $x \approx 0$ the term ax dominates so that, close to $x = 0$, the function behaves as

$$y \approx ax.$$

This is a straight line with slope a . Hence, near the origin, if $a > 0$ we would see a line with positive slope, whereas if $a < 0$ the slope of the line should be negative. Far away from the origin, the cubic term dominates, so

$$y \approx x^3$$

at large (positive or negative) x values. Figure 1.4 illustrates these ideas.

Concept Check-In

6. Justify why the linear term dominates near the origin, while the cubic term dominates further out.

7. Sketch the graph of *any* function with horizontal asymptote $y = 2$.

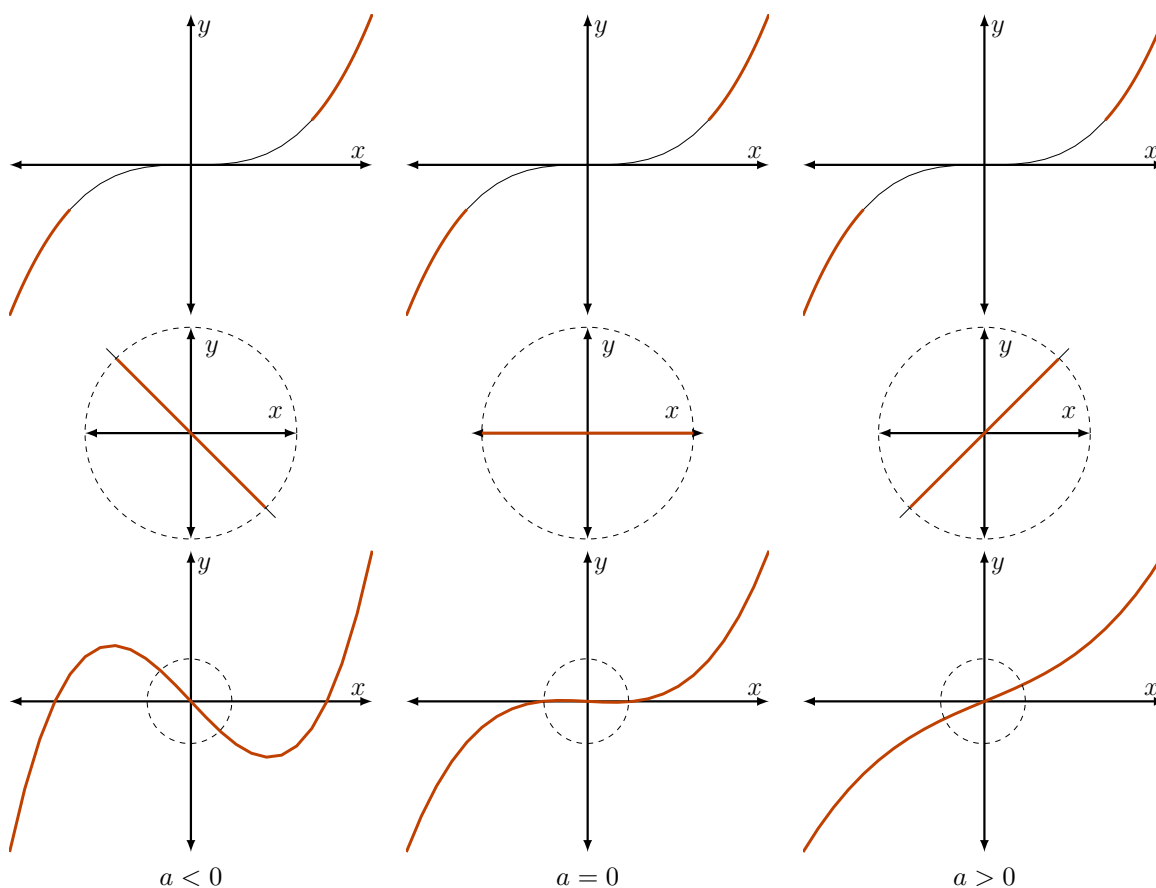

Figure 1.4: The graph of the polynomial $y = p(x) = x^3 + ax$ can be obtained by combining its two power function components. The cubic “arms” $y \approx x^3$ (top row) dominate for large x (far from the origin), while the linear part $y \approx ax$ (middle row) dominates near the origin. When these are smoothly connected (bottom row) we obtain a sketch of the desired polynomial. Shown here are three possibilities, for $a < 0, a = 0, a > 0$, left to right. The value of a determines the slope of the curve near $x = 0$ and thus also affects presence of a local maximum and minimum (for $a < 0$).

In the first row we see the behaviour of $y = p(x) = x^3 + ax$ for large x , in the second for small x . The last row shows the graph for an intermediate range. We might notice that for $a < 0$, the graph has a local minimum as well as a local maximum. Such an argument already leads to a fairly reasonable sketch of the function in Eqn. (1.2.1). We can add further details using algebra to find **zeros** - that is where $y = p(x) = 0$.

Example 1.2.3

Example 1.2.4 (Zeros)

Find the places at which the polynomial Eqn. (1.2.1) crosses the x axis, that is, find the **zeros** of the function $y = x^3 + ax$.

The zeros of the polynomial can be found by setting

$$y = p(x) = 0 \quad \Rightarrow \quad x^3 + ax = 0 \quad \Rightarrow \quad x^3 = -ax.$$

The above equation always has a solution $x = 0$, but if $x \neq 0$, we can cancel and obtain

$$x^2 = -a.$$

This would have no solutions if a is a positive number, so that in that case, the graph crosses the x axis only once, at $x = 0$, as shown in Figure 1.4. If a is negative, then the minus signs cancel, so the equation can be written in the form

$$x^2 = |a|$$

and we would have two new zeros at

$$x = \pm\sqrt{|a|}.$$

For example, if $a = -1$ then the function $y = x^3 - x$ has zeros at $x = 0, 1, -1$.

Concept Check-In

8. Find the zeros of $y = x^3 + 3x$.

Example 1.2.4

Example 1.2.5 (A more general case)

Explain how you would use the ideas of Example 1.2.3 to sketch the polynomial $y = p(x) = ax^n + bx^m$. Without loss of generality, you may assume that $n > m \geq 1$ are integers.

As in Example 1.2.3, this polynomial has two terms that dominate at different ranges of the independent variable. Close to the origin, $y \approx bx^m$ (since m is the lower power) whereas for large x , $y \approx ax^n$. The full behaviour is obtained by smoothly connecting these pieces of the graph. Finding zeros can refine the graph.

Example 1.2.5

The reasoning used here is an important first step in sketching the graph of a polynomial. In the ensuing chapters, we apply calculus tools to determine points at which the function attains local maxima or minima, and how it behaves for very large positive or negative values of x . We also develop specialized methods to find zeros of more complicated functions (using an approximation technique called Newton's method—although this is flavour-dependent). That said, the elementary steps described here remain useful as a quick approach for visualizing the overall shape of a graph.

►► (optional) Sketching a simple rational function

We apply similar reasoning to consider the graphs of simple rational functions. A **rational function** is a function that can be written as

$$y = \frac{p_1(x)}{p_2(x)}, \quad \text{where } p_1(x) \text{ and } p_2(x) \text{ are polynomials.}$$

Example 1.2.6 (A rational function)

Sketch the graph of the rational function

$$y = \frac{Ax^n}{a^n + x^n}, \quad x \geq 0. \quad (1.2.2)$$

What properties of your sketch depend on the power n ? What would the graph look like for $n = 1, 2, 3$?

 Adjust the sliders to see how the values of n , A , and a affect the shape of the rational function in (1.2.2).

We can break up the process of sketching this function into the following steps:

- The graph of the function in Eqn. (1.2.2) goes through the origin (at $x = 0$, we see that $y = 0$).
- For very small x , (i.e., $x \ll a$) we can approximate the denominator by the constant term $a^n + x^n \approx a^n$, since x^n is negligible by comparison, so that

$$y = \frac{Ax^n}{a^n + x^n} \approx \frac{Ax^n}{a^n} = \left(\frac{A}{a^n}\right)x^n \quad \text{for small } x.$$

This means that near the origin, the graph looks like a power function, $y \approx Cx^n$ (where $C = A/a^n$).

- For large x , i.e. $x \gg a$, we have $a^n + x^n \approx x^n$ since x overtakes and dominates over the constant a , so that

$$y = \frac{Ax^n}{a^n + x^n} \approx \frac{Ax^n}{x^n} = A \quad \text{for large } x.$$

This reveals that the graph has a horizontal asymptote $y = A$ at large values of x .

- Since the function behaves like a simple power function close to the origin, we conclude directly that the higher the value of n , the flatter is its graph near 0. Further, large n means sharper rise to the eventual asymptote.

The results are displayed in Figure 1.5.

Example 1.2.6

1.3 ▲ (optional) Rate of an enzyme-catalyzed reaction

Rational functions introduced in Example 1.2.6 often play a role in biochemistry. Here we discuss two such examples and the contexts in which they appear. In both cases, we consider the initial rise of the function as well as its eventual saturation.

►► Saturation and Michaelis-Menten kinetics

Biochemical reactions are often based on the action of proteins known as **enzymes** that catalyze reactions in living cells. Fig. 1.6 depicts an enzyme E binding to its **substrate** S to form a **complex** C . The complex breaks apart into a **product**, P , and the original enzyme that can act once more. Substrate is usually plentiful relative to the enzyme.

In the context of this example, x represents the concentration of substrate in the reaction mixture. The speed of the reaction, v , (namely the rate at which product is formed) depends on x . When

6 Although a^n looks complicated, it's actually just a constant. Do you see why?

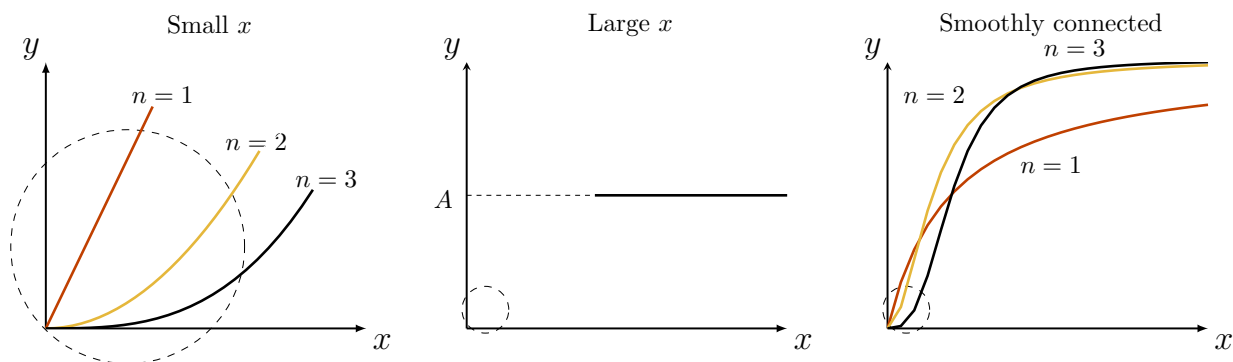

Figure 1.5: The rational functions Eqns.(1.2.2) with $n = 1, 2, 3$ are compared on this graph. Close to the origin, the function behaves like a power function, whereas for large x there is a horizontal asymptote at $y = A$. As n increases, the graph becomes flatter close to the origin, and steeper in its rise to the asymptote.

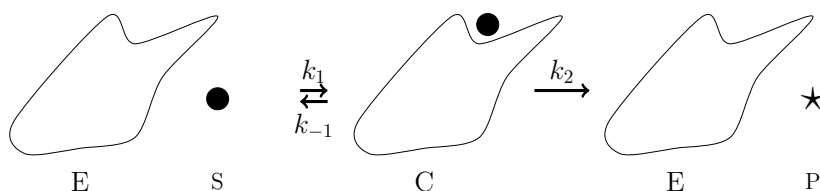

Figure 1.6: An enzyme (catalytic protein) is shown binding to a substrate molecule (circular dot) and then processing it into a product (star shaped molecule).

you actually graph the speed of the reaction as a function of the concentration, you see that it is not linear: Figure 1.7 is typical. This relationship, known as **Michaelis-Menten** kinetics, has the mathematical form

$$\text{speed of reaction} = v = \frac{Kx}{k_n + x}, \quad (1.3.1)$$

where $K, k_n > 0$ are constants specific to the enzyme and the experimental conditions.

Equation (1.3.1) is a rational function. Since x is a concentration, it must be a positive quantity, so we restrict attention to $x \geq 0$. The expression in Eqn. (1.3.1) is a special case of the rational functions explored in Example 1.2.6, where $n = 1, A = K, a = k_n$. In Figure 1.7, we used plot this function for specific values of K, k_n . The following observations can be made

1. The graph of Eqn. (1.3.1) goes through the origin. Indeed, when $x = 0$ we have $v = 0$.
2. Close to the origin, the initial rise of the graph “looks like” a straight line. We can see this by considering values of x that are much smaller than k_n . Then the denominator $(k_n + x)$ is well approximated by the constant k_n . Thus, for small x , $v \approx (K/k_n)x$, so that the graph resembles a straight line through the origin with slope (K/k_n) .
3. For large x , there is a horizontal asymptote. A similar argument for $x \gg k_n$, verifies that v is approximately constant at large enough x .

Michaelis-Menten kinetics represents one relationship in which **saturation** occurs: the speed of the reaction at first increases as substrate concentration x is raised, but the enzymes saturate and operate at a fixed constant speed K as more and more substrate is added.

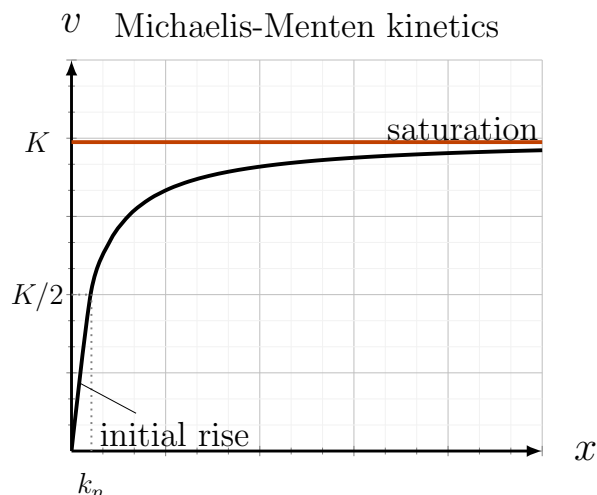

Figure 1.7: The graph of reaction speed, v , versus substrate concentration, x in an enzyme-catalyzed reaction, as in Eqn. 1.3.1. This behaviour is called Michaelis-Menten kinetics. Note that the graph at first rises almost like a straight line, but then it curves and approaches a horizontal asymptote. This graph tells us that the speed of the enzyme cannot exceed some fixed level, i.e. it cannot be faster than K .

	units	example
x	concentration	“nano Molar”, $nM \equiv 10^{-9}$ Moles per litre
v	concentration over time	$nM \text{ min}^{-1}$
k_n		
K		

Table 1.1: Units for Michaelis-Menten kinetics, $v = \frac{Kx}{k_n+x}$. (Incomplete; see Concept Check-In, below.)

It is worth considering the units in Eqn. (1.3.1). Given that only quantities with identical units can be added or compared, and that the units of the two sides of the relationship *must balance*, fill Table 1.1.

Concept Check-In

9. Complete Table 1.1.

Featured Problem 1.3.1 (Fish population growth 1)

The Beverton-Holt model relates the number of salmon in a population this year N_1 to the number of salmon that were present last year N_0 , according to the relationship

$$N_1 = k_1 \frac{N_0}{(1 + k_2 N_0)}, \quad k_1, k_2 > 0 \quad (1.3.2)$$

Sketch N_1 as a function of N_0 and explain how the constants k_1 and k_2 affect the shape of the graph you obtain. Is there a population level N_0 that would be exactly the same from one year to the next?

Are there any restrictions on k_1 or k_2 for this kind of static (“steady state”) population to be possible?

Featured Problem 1.3.1

►► Hill functions

The Michaelis-Menten kinetics we discussed above fit into a broader class of **Hill functions**, which are rational functions of the form shown in Eqn. (1.2.2) with $n > 1$ and $A, a > 0$. This function is often referred to in the life sciences as a *Hill function with coefficient n* , (although the “coefficient” is actually a power in the terminology used in this chapter). Hill functions occur when an enzyme-catalyzed reaction benefits from **cooperativity** of a multi-step process. For example, the binding of the first substrate molecule may enhance the binding of a second.

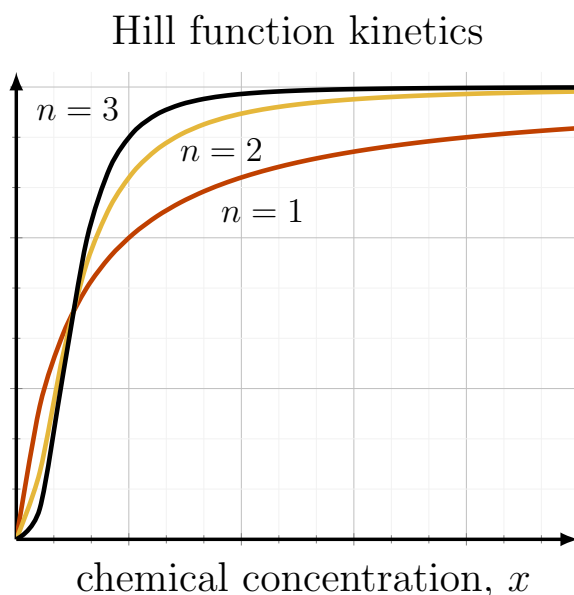

Figure 1.8: Hill function kinetics, from Eqn. (1.2.2), with $A = 3, a = 1$ and Hill coefficient $n = 1, 2, 3$. See also Fig 1.5 for an analysis of the shape of this graph.

Michaelis-Menten kinetics coincides with a Hill function for $n = 1$. In biochemistry, expressions of the form of Eqn. (1.2.2) with $n > 1$ are often denoted “sigmoidal” kinetics. Several such functions are plotted in Figure 1.8. We examined the shapes of these functions in Example 1.2.6.

All Hill functions have a horizontal asymptote $y = A$ at large values of x . If y is the speed of a chemical reaction (analogous to the variable we called v), then A is the “maximal rate” or “maximal speed” of the reaction. Since the Hill function behaves like a simple power function close to the origin, the higher the value of n , the flatter is its graph near 0, and the sharper the rise to the eventual asymptote. Hill functions with large n are often used to represent “switch-like” behaviour in genetic networks or biochemical signal transduction pathways.

The constant a is sometimes called the “half-maximal activation level” for the following reason: when $x = a$ then

$$v = \frac{Aa^n}{a^n + a^n} = \frac{Aa^2}{2a^2} = \frac{A}{2}.$$

This shows that the level $x = a$ leads to a reaction speed of $A/2$ which is half of the maximal possible rate.

Featured Problem 1.3.2

Lineweaver-Burk plots. Hill functions can be transformed to a linear relationship through a change of variables. Consider the Hill function

$$y = \frac{Ax^3}{a^3 + x^3}.$$

define $y = 1/Y$, $X = 1/x^3$. Show that Y and X satisfy a linear relationship. Because we take the reciprocals of x and y , X and Y are sometimes called *reciprocal coordinates*.

Featured Problem 1.3.2

1.4 ▲ (optional) Predator response

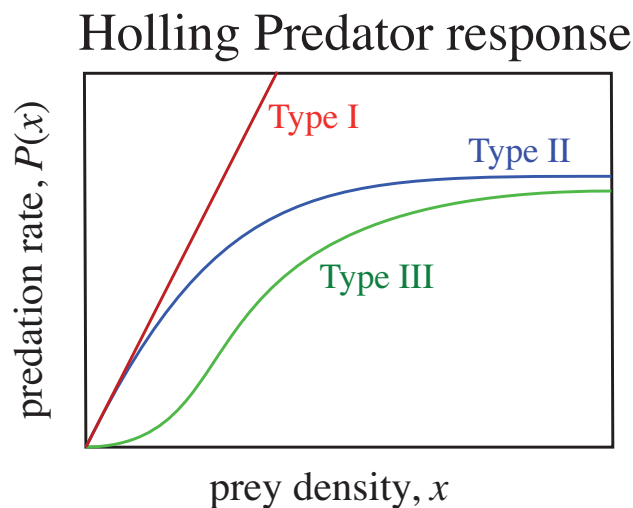

Figure 1.9: Holling’s Type I, II, and III predator response. The predation rate $P(x)$ is the number of prey eaten by a predator per unit time. Note that the predation rate depends on the prey density x .

Interactions of predators and prey are often studied in ecology. Professor C.S. (“Buzz”) Holling, (a former Director of the Institute of Animal Resource Ecology at the University of British Columbia) described three types of predators, termed “Type I”, “Type II” and “Type III”, according to their ability to consume prey as the prey density increases. The three Holling “predator functional responses” are shown in Fig. 1.9.

Based on Fig. 1.9, match the predator responses to functions shown below.

Hint: One of the curves “looks like a straight line” (so which function here is linear?). One of the choices is a power function. (Will it fit any of the other curves? why or why not?). Now consider the saturating curves and use our description of rational functions in Section 1.3 to select appropriate formulae for these functions.

$$P_1(x) = kx,$$

$$P_2(x) = K \frac{x}{a+x},$$

$$P_3(x) = Kx^n, \quad n \geq 2$$

$$P_4(x) = K \frac{x^n}{a^n + x^n}, \quad n \geq 2$$

The generality of mathematics allows us to adapt concepts we studied in one setting (enzyme biochemistry) to an apparently new topic (behaviour of predators).

Concept Check-In

1. Match the predator responses shown in Fig. 1.9 with the descriptions given below

1. As a predator, I get satiated and cannot keep eating more and more prey.
2. I can hardly find the prey when the prey density is low, but I also get satiated at high prey density.
3. The more prey there is, the more I can eat.

►► A ladybug eating aphids

Here we use ideas developed so far to address a problem in population growth and biological control.

Featured Problem 1.4.1 (A balance of predation and aphid population growth)

Ladybugs are predators that love to eat aphids (their prey).

▶ See this short video explanation of the ladybug Type III predator response to its aphid prey.

Fig. 1.10 provides data ⁷ that supports the idea that ladybugs are type 3 predators.

Let x = the number of aphids in some unit area (i.e., the density of the prey). Then the number of aphids eaten by a ladybug per unit time in that unit area will be called the **predation rate** and denoted $P(x)$. The predation rate usually depends on the prey density, and we approximate that dependence by

$$P(x) = K \frac{x^n}{a^n + x^n}, \quad \text{where } K, a > 0. \quad (1.4.1)$$

Here we consider the case that $n = 2$. The aphids reproduce at a rate proportional to their number, so that the growth rate of the aphid population G (number of new aphids per hour) is

$$G(x) = rx \quad \text{where } r > 0. \quad (1.4.2)$$

⁷ source: Hassell, M. P., Lawton, J. H., & Beddington, J. R. (1977). Sigmoid Functional Responses by Invertebrate Predators and Parasitoids. *Journal of Animal Ecology*, 46(1), 249–262. <https://doi.org/10.2307/3959>

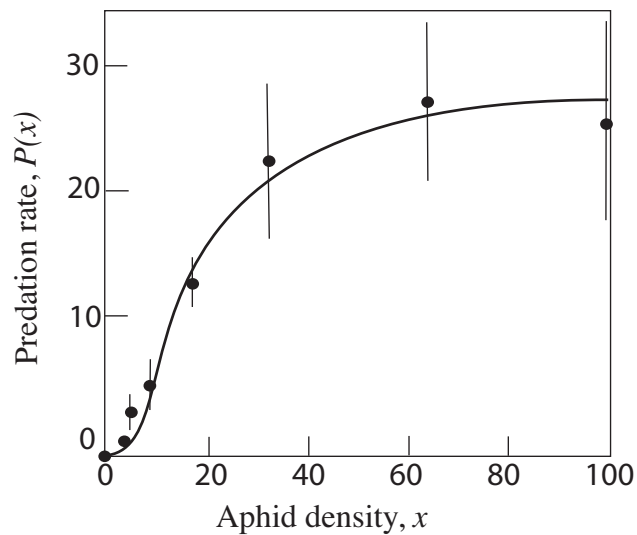



Figure 1.10: The predation rate of a ladybug depends on its aphid (prey) density.

- (a) For what aphid population density x does the predation rate exactly balance the aphid population growth rate?
- (b) Are there situations where the predation rate cannot match the growth rate? Explain your results in terms of the constants K, a, r .

Featured Problem 1.4.1

Hints and partial solution

- (a) The wording “the predation rate exactly balances the reproduction rate” means that the two functions $P(x)$ and $G(x)$ are exactly equal.

 Use the sliders to manipulate the predation constants K, a and the aphid growth rate parameter r . How many solutions are there to $P(x) = G(x)$? Show that for some parameter values, there is only a trivial solution at $x = 0$. Make a connection between this observation and part (b) of Example 1.4.1.

Hence, to solve this problem, equate $P(x) = G(x)$ and determine the value of x (i.e., the number of aphids) at which this equality holds. You will find that one solution to this equation is $x = 0$. But if $x \neq 0$, you can cancel one factor of x from both sides and rearrange the equation to obtain a quadratic equation whose solution can be written down (in terms of the positive constants K, r, a).

Hint: Recall that a quadratic equation $ax^2 + bx + c = 0$ has roots^a

$$x = \frac{-b \pm \sqrt{b^2 - 4ac}}{2a}.$$

These roots are real provided

$$b^2 - 4ac \geq 0.$$

a The solution to this problem is based on solving a quadratic equation, and so, relies on the fact that we chose the value $n = 2$ in the predation rate. To solve the same kind of problem with $n = 3, 4$ etc generally requires numerical approximation methods.

- (b) The solution you find in (a) is only a real number (i.e. a real solution exists) if the **discriminant** (quantity inside the square-root) is positive. Determine when this situation can occur and interpret your answer in terms of the aphid and ladybugs.

1.5 ▲ Familiar functions

Learning Objectives

- Know that e^x eventually dominates any given power function, and any power function with positive exponent dominates logarithm (for large positive x). Use these facts for sketching. For example, sketch $f(x) = e^x - x$.
- Sketch familiar functions such as e^x , $\log x$, $\sin x$, $\cos x$, $\tan x$, $1/x$, \sqrt{x} , and $|x|$.

Power functions are both common and (relatively) simple, so they were a good place to start thinking about dominance and how it can be useful. Another common class of functions are the exponential functions: those of the form $f(x) = a^x$, where a is a positive constant. (The one we'll be using the most, sometimes called *the* exponential function, is e^x .) The constant a is known as the *base*.

Example 1.5.1 (Bases of exponential functions)

Below are graphed $y = 2^x$, $y = 3^x$, and $y = 4^x$. Note that, as the bases increase, the functions get steeper for positive x .

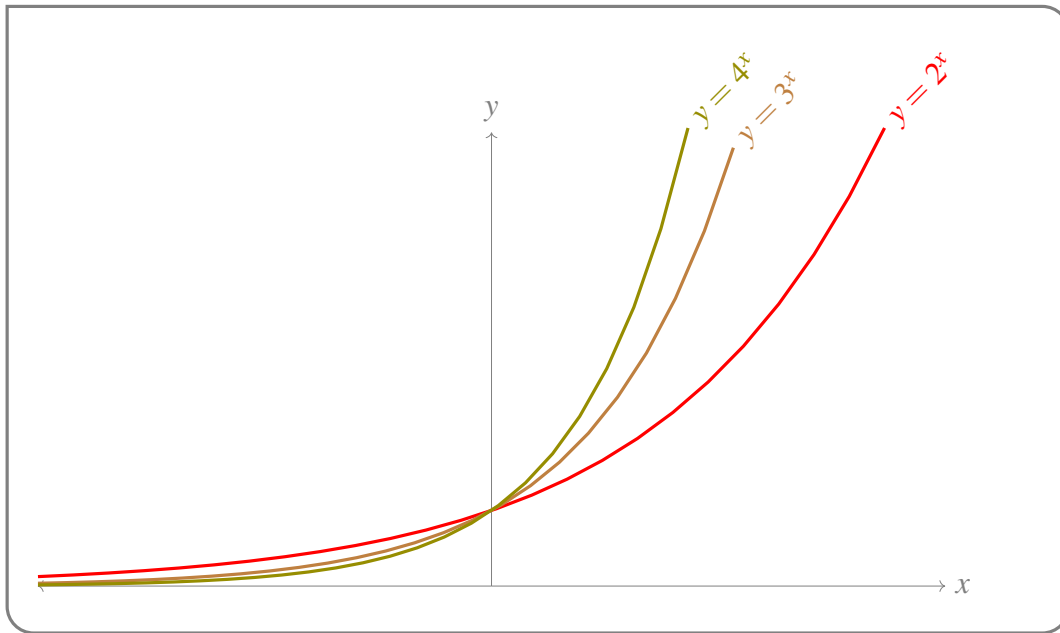

Example 1.5.1

Exponential functions with bases greater than one will, for large x , grow extremely quickly. Indeed, they will grow more quickly than any power function, eventually.

Example 1.5.2 ($e^x - x$.)

Let's sketch $y = e^x - x$.

- For large positive values of x , e^x will dominate $-x$, so the function will look approximately like e^x . That is, it will grow steeply.
- For large negative values of x , $e^x \approx 0$, so $e^x - x \approx -x$.
- For $x = 0$, $e^0 - 0 = 1$.

So, all together: our function will look like the straight line $-x$ when x is strongly negative; then it will pass through the point $(0, 1)$; then it will grow like the classic hockey-stick graph of e^x for large x .

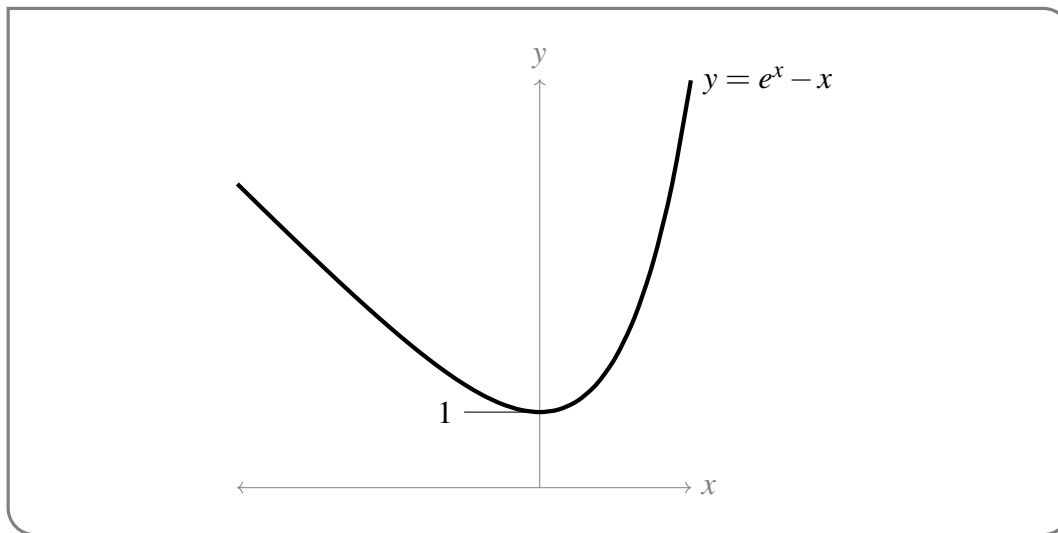

Example 1.5.2

Below are some familiar functions whose graphs you should be able to sketch. Some salient points are stated explicitly.

e^x :

- Domain is all real numbers. Range is all positive numbers.
- Passes through the point $(0, 1)$.
- e^x is very close to 0 for large negative values of x ; e^x grows rapidly and without bound for large positive values of x .

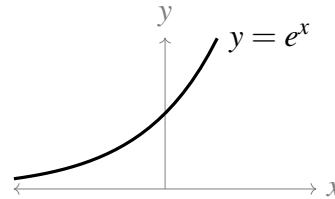

$\log(x)$:

- In this course we use $\log(x) = \log_e(x) = \ln(x)$. This differs from some calculators. When using online calculators, put in a few test points to see which base is used for the 'log' button.
- Is the inverse of the exponential function.
- Passes through the point $(1, 0)$.
- Domain is $(0, \infty)$; range is all real numbers.
- For very large positive x values, $\log x$ is very big and positive.
- For very small positive x values, $\log x$ is very big and negative.

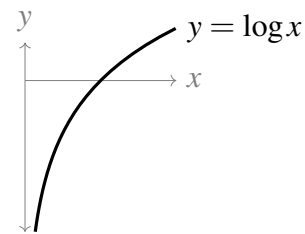

$\sin(x)$:

- Range is $[-1, 1]$. Domain is all real numbers.
- Passes through the origin.
- You should know the value of this function at reference angles, and its relation with the unit circle.

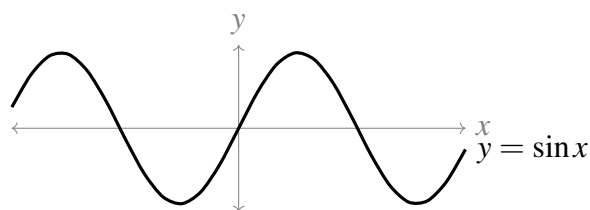
 $\cos(x)$:

- Range is $[-1, 1]$. Domain is all real numbers.
- Passes through the point $(0, 1)$.
- You should know the value of this function at reference angles, and its relation with the unit circle.

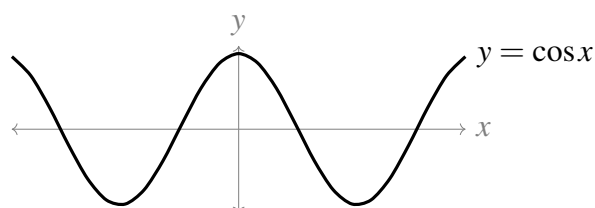
 $\tan(x)$:

- Range is all real numbers. Not defined for $x = n\pi + \frac{\pi}{2}$, where n is any integer.
- Passes through the origin. Blows up near points where it isn't defined.
- You should know the value of this function at reference angles, and its relation with sine and cosine.

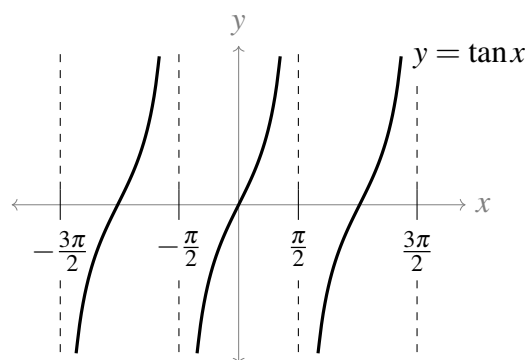
 $\frac{1}{x}$:

- Domain and range are both all nonzero real numbers.
- For values of x close to 0, $\frac{1}{x}$ is very large (positive or negative).
- For large (positive or negative) values of x , $\frac{1}{x}$ is close to 0.

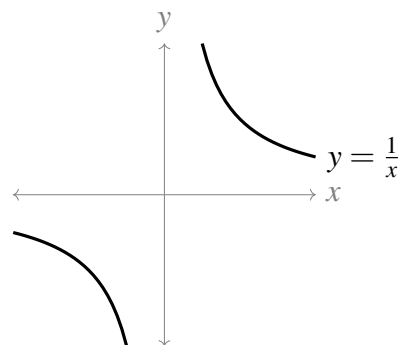
 \sqrt{x} :

- Domain and range are both $[0, \infty)$.

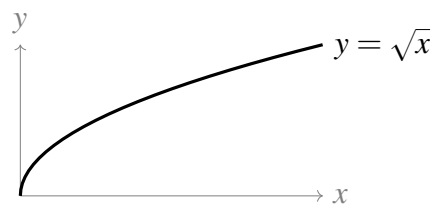

- For large values of x , \sqrt{x} is also large.

$|x|$:

- Piecewise defined: $|x| = \begin{cases} x & \text{if } x \geq 0 \\ -x & \text{if } x < 0 \end{cases}$.
- Domain all real numbers; range $[0, \infty)$.
- Looks like a straight line if you only look to one side of the y -axis.

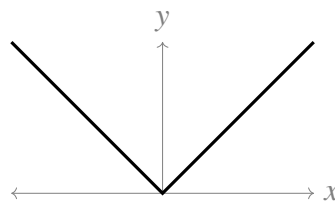

LIMITS

The concept of a **limit** helps us to describe the behaviour of a function close to some point of interest. This is useful in the case of functions that are either *not continuous*, or *not defined* somewhere. We use the notation

$$\lim_{x \rightarrow a} f(x)$$

to denote the value that the function f approaches as x gets closer and closer to the value a .

2.1 ▲ Quick review of limits

Learning Objectives

- Explain using both words and pictures what $\lim_{x \rightarrow a} f(x) = L$, $\lim_{x \rightarrow a^-} f(x) = L$, and $\lim_{x \rightarrow a^+} f(x) = L$ mean (including the case where L is equal to ∞ or $-\infty$).
- Explain using both words and pictures what $\lim_{x \rightarrow \infty} f(x) = L$ and $\lim_{x \rightarrow -\infty} f(x) = L$ mean (including the case where L is equal to ∞ or $-\infty$).
- Find the limit of a function at a point given the graph of the function.
- Understand when limits do and do not exist.

Before we come to definitions, let us start with a little notation for limits.

Notation 2.1.1.

We will often write

$$\lim_{x \rightarrow a} f(x) = L$$

which should be read as

The limit of $f(x)$ as x approaches a is L .

The notation is just shorthand — we don't want to have to write out long sentences as we do our mathematics. Whenever you see these symbols you should think of that sentence.

This shorthand also has the benefit of being mathematically precise (albeit not in a way that we will cover in this course), and (almost) independent of the language in which the author is writing. A mathematician who does not speak English can read the above formula and understand exactly what it means.

In mathematics, like most languages, there is usually more than one way of writing things and we can also write the above limit as

$$f(x) \rightarrow L \text{ as } x \rightarrow a$$

This can also be read as above, but also as

$$f(x) \text{ goes to } L \text{ as } x \text{ goes to } a$$

They mean exactly the same thing in mathematics, even though they might be written and read a little differently.

To arrive at the definition of limit, we want to start with a very simple example.

Example 2.1.2

Consider the following function.

$$f(x) = \begin{cases} 2x & x < 3 \\ 9 & x = 3 \\ 2x & x > 3 \end{cases}$$

This is an example of a piecewise function. That is, a function defined in several pieces, rather than as a single formula. We evaluate the function at a particular value of x on a case-by-case basis. Here is a sketch of it:

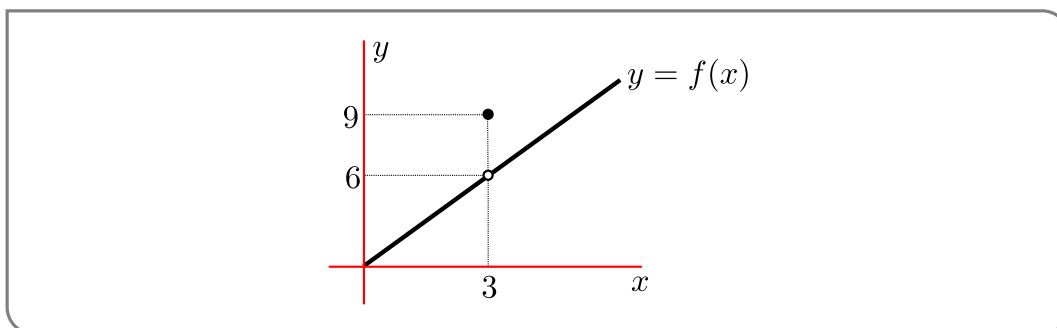

Notice the two circles in the plot. One is open, \circ , and the other is closed, \bullet .

- A filled circle has quite a precise meaning — a filled circle at (x, y) means that the function takes the value $f(x) = y$.
- An open circle is a little harder — an open circle at $(3, 6)$ means that the point $(3, 6)$ is not on the graph of $y = f(x)$, i.e. $f(3) \neq 6$. We should only use the open circle where it is absolutely necessary in order to avoid confusion.

This function is quite contrived, but it is a very good example to start working with limits more systematically. Consider what the function does close to $x = 3$. We already know what happens exactly at 3 (that is, $f(x) = 9$) but we want to look at how the function behaves *very close* to $x = 3$. That is, what does the function do as we look at a point x that gets closer and closer to $x = 3$?

If we plug in some numbers very close to 3 (but not exactly 3) into the function we see the following:

x	2.9	2.99	2.999	\circ	3.001	3.01	3.1
$f(x)$	5.8	5.98	5.998	\circ	6.002	6.02	6.2

So as x moves closer and closer to 3, without being exactly 3, we see that the function moves closer and closer to 6. We can write this as

$$\lim_{x \rightarrow 3} f(x) = 6$$

That is:

The limit as x approaches 3 of $f(x)$ is 6.

So for x very close to 3, without being exactly 3, the function is very close to 6 — which is a long way from the value of the function exactly at 3, $f(3) = 9$. Note well that the behaviour of the function as x gets very close to 3 *does not* depend on the value of the function *at* 3.

Example 2.1.2

We now have enough to make an informal definition of a limit, which is actually sufficient for most of what we will do in this text.

Definition 2.1.3 (Informal definition of limit).

We write

$$\lim_{x \rightarrow a} f(x) = L$$

if the value of the function $f(x)$ is sure to be arbitrarily close to L whenever the value of x is close enough to a , without¹ being exactly a .

1 You may find the condition “without being exactly a ” a little strange, but there is a good reason for it. One very important application of limits, indeed the main reason we teach the topic, is in the definition of derivatives (see Definition 3.3.3). In that definition we need to compute the limit $\lim_{x \rightarrow a} \frac{f(x) - f(a)}{x - a}$. In this case the function whose limit is being taken, namely $\frac{f(x) - f(a)}{x - a}$, is not defined at all at $x = a$.

Let us use the above definition to examine a more substantial example.

Example 2.1.4

Let $f(x) = \frac{x-2}{x^2+x-6}$ and consider its limit as $x \rightarrow 2$.

- We are really being asked

$$\lim_{x \rightarrow 2} \frac{x-2}{x^2+x-6} = \text{what?}$$

- Now if we try to compute $f(2)$ we get $0/0$ which is undefined. The function is not defined at that point — this is a good example of why we need limits. We have to sneak up on these places where a function is not defined (or is badly behaved).
- **VERY IMPORTANT POINT:** the fraction $\frac{0}{0}$ is *not* ∞ and it is not 1; it is not defined. We cannot ever divide by zero in normal arithmetic and obtain a consistent and mathematically sensible answer. If you learned otherwise in high school, you should quickly unlearn it.
- Again, we can plug in some numbers close to 2 and see what we find

x	1.9	1.99	1.999	○	2.001	2.01	2.1
$f(x)$	0.20408	0.20040	0.20004	○	0.19996	0.19960	0.19608

- So it is reasonable to suppose that

$$\lim_{x \rightarrow 2} \frac{x-2}{x^2+x-6} = 0.2$$

Example 2.1.4

The previous two examples are nicely behaved in that the limits we tried to compute actually exist. We now turn to two nastier examples² in which the limits we are interested in do not exist.

Example 2.1.5 (A bad example)

Consider the following function $f(x) = \sin(\pi/x)$. Find the limit as $x \rightarrow 0$ of $f(x)$.

We should see something interesting happening close to $x = 0$ because $f(x)$ is undefined there. Using your favourite graph-plotting software you can see that the graph looks roughly like

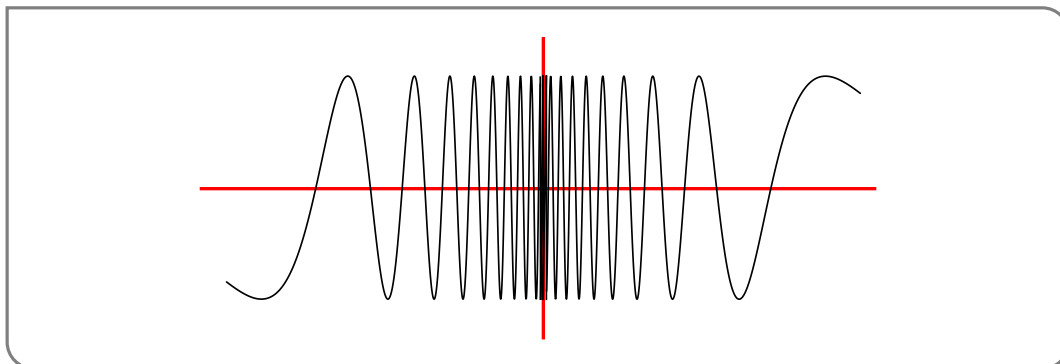

² Actually, they are good examples, but the functions in them are nastier.

How to explain this? As x gets closer and closer to zero, π/x becomes larger and larger (remember what the plot of $y = 1/x$ looks like). So when you take sine of that number, it oscillates faster and faster the closer you get to zero. Since the function does not approach a single number as we bring x closer and closer to zero, the limit does not exist.

We write this as

$$\lim_{x \rightarrow 0} \sin\left(\frac{\pi}{x}\right) \text{ does not exist}$$

It's not very inventive notation, however it is clear. We frequently abbreviate "does not exist" to "DNE" and rewrite the above as

$$\lim_{x \rightarrow 0} \sin\left(\frac{\pi}{x}\right) = \text{DNE}$$

Example 2.1.5

In the following example, the limit we are interested in does not exist. However the way in which things go wrong is quite different from what we just saw.

Example 2.1.6

Consider the function

$$f(x) = \begin{cases} x & x < 2 \\ -1 & x = 2 \\ x + 3 & x > 2 \end{cases}$$

- The plot of this function looks like this

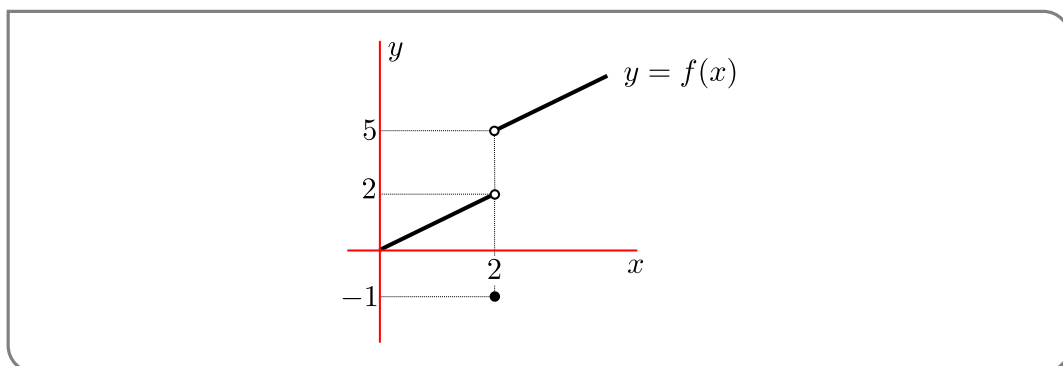

- So let us plug in numbers close to 2.

x	1.9	1.99	1.999	\circ	2.001	2.01	2.1
$f(x)$	1.9	1.99	1.999	\circ	5.001	5.01	5.1

- This isn't like before. Now when we approach from below, we seem to be getting closer to 2, but when we approach from above we seem to be getting closer to 5. Since we are not approaching the same number the limit does not exist.

$$\lim_{x \rightarrow 2} f(x) = \text{DNE}$$

Example 2.1.6

While the limit in the previous example does not exist, the example serves to introduce the idea of “one-sided limits”. For example, we can say that

As x moves closer and closer to two *from below* the function approaches 2.

and similarly

As x moves closer and closer to two *from above* the function approaches 5.

Definition 2.1.7 (Informal definition of one-sided limits).

We write

$$\lim_{x \rightarrow a^-} f(x) = K$$

when the value of $f(x)$ gets closer and closer to K when $x < a$ and x moves closer and closer to a . Since the x -values are always less than a , we say that x approaches a *from below*. This is also often called the left-hand limit since the x -values lie to the left of a on a sketch of the graph.

We similarly write

$$\lim_{x \rightarrow a^+} f(x) = L$$

when the value of $f(x)$ gets closer and closer to L when $x > a$ and x moves closer and closer to a . For similar reasons we say that x approaches a from above, and sometimes refer to this as the right-hand limit.

Note — be careful to include the superscript $+$ and $-$ when writing these limits. You might also see the following notations:

$$\begin{array}{ll} \lim_{x \rightarrow a^+} f(x) = \lim_{x \rightarrow a^+} f(x) = \lim_{x \downarrow a} f(x) = \lim_{x \searrow a} f(x) = L & \text{right-hand limit} \\ \lim_{x \rightarrow a^-} f(x) = \lim_{x \rightarrow a^-} f(x) = \lim_{x \uparrow a} f(x) = \lim_{x \nearrow a} f(x) = L & \text{left-hand limit} \end{array}$$

but please use with the notation in Definition 2.1.7 above.

Given these two similar notions of limits, when are they the same? The following theorem tell us

Theorem 2.1.8 (Limits and one sided limits).

$$\lim_{x \rightarrow a} f(x) = L \quad \text{if and only if} \quad \lim_{x \rightarrow a^-} f(x) = L \quad \text{and} \quad \lim_{x \rightarrow a^+} f(x) = L$$

Notice that this is really two separate statements because of the “if and only if”

- If the limit of $f(x)$ as x approaches a exists and is equal to L , then both the left-hand and right-hand limits exist and are equal to L . AND,
- If the left-hand and right-hand limits as x approaches a exist and are equal, then the limit as x approaches a exists and is equal to the one-sided limits.

That is — the limit of $f(x)$ as x approaches a will only exist if it doesn't matter which way we approach a (either from left or right) AND if we get the same one-sided limits when we approach from left and right, then the limit exists.

We can rephrase the above by writing the contrapositives³ of the above statements.

- If either of the left-hand and right-hand limits as x approaches a fail to exist, or if they both exist but are different, then the limit as x approaches a does not exist. AND,
- If the limit as x approaches a does not exist, then the left-hand and right-hand limits are either different or at least one of them does not exist.

Here is another limit example.

Example 2.1.9

Consider the following two functions and compute their limits and one-sided limits as x approaches 1:

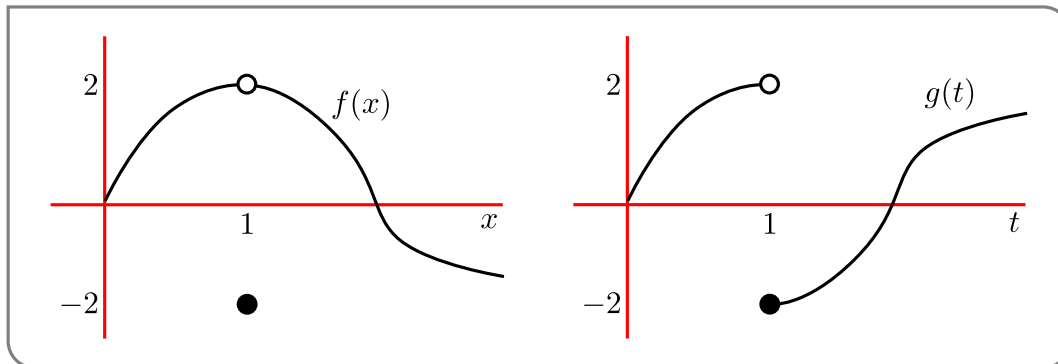

These are a little different from our previous examples, in that we do not have formulas, only the sketch. But we can still compute the limits.

- Function on the left — $f(x)$:

$$\lim_{x \rightarrow 1^-} f(x) = 2$$

$$\lim_{x \rightarrow 1^+} f(x) = 2$$

so by the previous theorem

$$\lim_{x \rightarrow 1} f(x) = 2$$

3 Given a statement of the form “If A then B”, the contrapositive is “If not B then not A”. They are logically equivalent — if one is true then so is the other. We must take care not to confuse the contrapositive with the converse. Given “If A then B”, the converse is “If B then A”. These are definitely not the same. To see this consider the statement “If he is Shakespeare then he is dead.” The converse is “If he is dead then he is Shakespeare” — clearly garbage since there are plenty of dead people who are not Shakespeare. The contrapositive is “If he is not dead then he is not Shakespeare” — which makes much more sense.

- Function on the right — $g(t)$:

$$\lim_{t \rightarrow 1^-} g(t) = 2$$

$$\text{and } \lim_{t \rightarrow 1^+} g(t) = -2$$

so by the previous theorem

$$\lim_{t \rightarrow 1} g(t) = \text{DNE}$$

Example 2.1.9

We have seen two ways in which a limit does not exist — in one case the function oscillated wildly, and in the other there was some sort of “jump” in the function, so that the left-hand and right-hand limits were different.

There is a third way that we must also consider. To describe this, consider the following four functions:

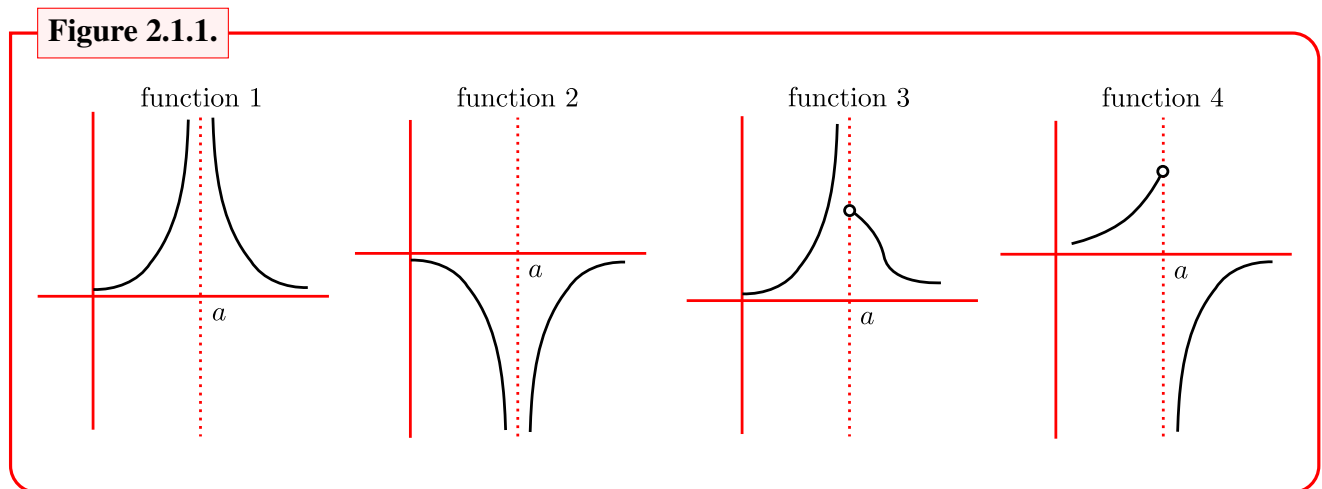

None of these functions are defined at $x = a$, nor do the limits as x approaches a exist. However we can say more than just “the limits do not exist”.

Notice that the value of function 1 can be made bigger and bigger as we bring x closer and closer to a . Similarly the value of the second function can be made arbitrarily large and negative (i.e. make it as big a negative number as we want) by bringing x closer and closer to a . Based on this observation we have the following definition.

Definition 2.1.10.

We write

$$\lim_{x \rightarrow a} f(x) = +\infty$$

when the value of the function $f(x)$ becomes arbitrarily large and positive as x gets closer and closer to a , without being exactly a .

Similarly, we write

$$\lim_{x \rightarrow a} f(x) = -\infty$$

when the value of the function $f(x)$ becomes arbitrarily large and negative as x gets closer and closer to a , without being exactly a .

A good example of the above is

$$\lim_{x \rightarrow 0} \frac{1}{x^2} = +\infty$$

$$\lim_{x \rightarrow 0} -\frac{1}{x^2} = -\infty$$

IMPORTANT POINT: Please do not think of “ $+\infty$ ” and “ $-\infty$ ” in these statements as numbers. You should think of $\lim_{x \rightarrow a} f(x) = +\infty$ and $\lim_{x \rightarrow a} f(x) = -\infty$ as special cases of $\lim_{x \rightarrow a} f(x) = \text{DNE}$. The statement

$$\lim_{x \rightarrow a} f(x) = +\infty$$

does not mean “ $f(x)$ approaches infinity as x approaches a .” It means “the function $f(x)$ becomes arbitrarily large as x approaches a ”. These are different statements; remember that ∞ is not a number⁴.

Warning 2.1.11.

There are multiple ways in which a limit can fail to exist. We use ∞ and $-\infty$ to describe limits that behave in a particular way, and reserve “DNE” for the ones that fail to exist for *other* reasons. So, if you are asked to evaluate $\lim_{x \rightarrow 0} \frac{1}{x^2}$, is **not** correct to write “DNE,” because the correct description of its behaviour is $\lim_{x \rightarrow 0} \frac{1}{x^2} = \infty$.

Now consider functions 3 and 4 in Figure 2.1.1. Here we can make the value of the function as big and positive as we want (for function 3) or as big and negative as we want (for function 4) but only when x approaches a from one side. With this in mind we can construct similar notation and a similar definition:

4 One needs to be very careful making statements about infinity. At some point in our lives we get around to asking ourselves “what is the biggest number?” and we realise there isn’t one. That is, we can go on counting integer after integer forever. Indeed the set of integers is the first infinite thing we really encounter. It is an example of a *countably infinite* set. The set of real numbers is actually much bigger and is *uncountably infinite*. In fact there are an infinite number of different sorts of infinity! Much of the theory of infinite sets was developed by Georg Cantor, who is well worth investigating.

Definition 2.1.12.

We write

$$\lim_{x \rightarrow a^+} f(x) = +\infty$$

when the value of the function $f(x)$ becomes arbitrarily large and positive as x gets closer and closer to a from above (equivalently — from the right), without being exactly a . Similarly, we write

$$\lim_{x \rightarrow a^+} f(x) = -\infty$$

when the value of the function $f(x)$ becomes arbitrarily large and negative as x gets closer and closer to a from above (equivalently — from the right), without being exactly a . The notation

$$\lim_{x \rightarrow a^-} f(x) = +\infty$$

$$\lim_{x \rightarrow a^-} f(x) = -\infty$$

has a similar meaning except that limits are approached from below / from the left.

So for function 3 we have

$$\lim_{x \rightarrow a^-} f(x) = +\infty$$

$$\lim_{x \rightarrow a^+} f(x) = \text{some positive number}$$

and for function 4

$$\lim_{x \rightarrow a^-} f(x) = \text{some positive number}$$

$$\lim_{x \rightarrow a^+} f(x) = -\infty$$

Example 2.1.13

Consider the function

$$g(x) = \frac{1}{\sin(x)}$$

Find the one-sided limits of this function as $x \rightarrow \pi$.

Probably the easiest way to do this is to first plot the graph of $\sin(x)$ and $1/x$ and then think carefully about the one-sided limits:

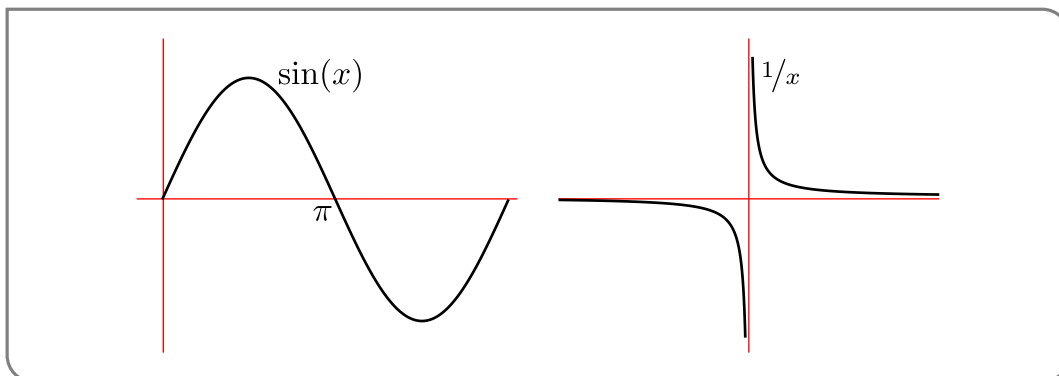

- As $x \rightarrow \pi$ from the left, $\sin(x)$ is a small positive number that is getting closer and closer to zero. That is, as $x \rightarrow \pi^-$, we have that $\sin(x) \rightarrow 0$ through positive numbers (i.e. from above). Now look at the graph of $1/x$, and think what happens as we move $x \rightarrow 0^+$, the function is positive and becomes larger and larger.

So as $x \rightarrow \pi$ from the left, $\sin(x) \rightarrow 0$ from above, and so $1/\sin(x) \rightarrow +\infty$.

- By very similar reasoning, as $x \rightarrow \pi$ from the right, $\sin(x)$ is a small negative number that gets closer and closer to zero. So as $x \rightarrow \pi$ from the right, $\sin(x) \rightarrow 0$ through negative numbers (i.e. from below) and so $1/\sin(x)$ to $-\infty$.

Thus

$$\lim_{x \rightarrow \pi^-} \frac{1}{\sin(x)} = +\infty$$

$$\lim_{x \rightarrow \pi^+} \frac{1}{\sin(x)} = -\infty$$

Example 2.1.13

Up to this point we explored limits by sketching graphs or plugging values into a calculator. This was done to help build intuition, but it is not really the basis of a systematic method for computing limits. We have also avoided more formal approaches⁵ since we do not have time in the course to go into that level of detail and (arguably) we don't need that detail to achieve the aims of the course. Thankfully we can develop a more systematic approach based on the idea of building up complicated limits from simpler ones by examining how limits interact with the basic operations of arithmetic.

2.1.1 ► Calculating limits with limit laws

Think back to the functions you know and the sorts of things you have been asked to draw, factor and so on. Then they are all constructed from simple pieces, such as

- constants — c
- monomials or power functions — x^n
- trigonometric functions — $\sin(x)$, $\cos(x)$ and $\tan(x)$

These are the building blocks from which we construct functions. Soon we will add a few more functions to this list, especially the exponential function and various inverse functions.

We then take these building blocks and piece them together using arithmetic

- addition and subtraction — $f(x) = g(x) + h(x)$ and $f(x) = g(x) - h(x)$
- multiplication — $f(x) = g(x) \cdot h(x)$
- division — $f(x) = \frac{g(x)}{h(x)}$
- substitution — $f(x) = g(h(x))$ — this is also called the composition of g with h .

5 The formal approaches are typically referred to as “epsilon-delta limits” or “epsilon-delta proofs” since the symbols ϵ and δ are traditionally used throughout. Your favourite search engine will tell you more, if you're curious.

What we will learn in this section is how to compute the limits of the basic building blocks and then how we can compute limits of sums, products and so forth using “limit laws”. This process allows us to compute limits of complicated functions, using very simple tools and without having to resort to “plugging in numbers” or “closer and closer” or “ $\epsilon - \delta$ arguments”.

In the examples we saw above, almost all the *interesting* limits happened at points where the underlying function was badly behaved — where it jumped, was not defined, or blew up to infinity. In those cases we had to be careful and think about what was happening. Thankfully most functions we will see do not have too many points at which these sorts of things happen.

For example, polynomials do not have any nasty jumps and are defined everywhere and do not “blow up”. If you plot them, they look smooth⁶. Polynomials and limits behave very nicely together, and for any polynomial $P(x)$ and any real number a we have that

$$\lim_{x \rightarrow a} P(x) = P(a)$$

That is — to evaluate the limit, we just plug in the number. We will build up to this result over the next few pages.

Let us start with the two easiest limits.

Theorem 2.1.14 (Easiest limits).

Let $a, c \in \mathbb{R}$. The following two limits hold

$$\lim_{x \rightarrow a} c = c$$

and

$$\lim_{x \rightarrow a} x = a.$$

Since we have not seen too many theorems yet, let us examine it carefully piece by piece.

- **Let $a, c \in \mathbb{R}$** — just as was the case for definitions, we start a theorem by defining terms and setting the scene. There is not too much scene to set: the symbols a and c are real numbers.
- **The following two limits hold** — this doesn’t really contribute much to the statement of the theorem, it just makes it easier to read.
- $\lim_{x \rightarrow a} c = c$ — when we take the limit of a constant function (for example think of $c = 3$), the limit is (unsurprisingly) just that same constant.
- $\lim_{x \rightarrow a} x = a$ — as we noted above for general polynomials, the limit of the function $f(x) = x$ as x approaches a given point a , is just a . This says something quite obvious — as x approaches a , x approaches a (if you are not convinced then sketch the graph).

Armed with only these two limits, we cannot do very much. But combining these limits with some arithmetic we can do quite a lot.

⁶ We have used this term in an imprecise way, but it does have a precise mathematical meaning.

Theorem 2.1.15 (Arithmetic of limits).

Let $a, c \in \mathbb{R}$, let $f(x)$ and $g(x)$ be defined for all x 's that lie in some interval about a (but f, g need not be defined exactly at a).

$$\lim_{x \rightarrow a} f(x) = F \qquad \lim_{x \rightarrow a} g(x) = G$$

exist with $F, G \in \mathbb{R}$. Then the following limits hold

- $\lim_{x \rightarrow a} (f(x) + g(x)) = F + G$ — limit of the sum is the sum of the limits.
- $\lim_{x \rightarrow a} (f(x) - g(x)) = F - G$ — limit of the difference is the difference of the limits.
- $\lim_{x \rightarrow a} cf(x) = cF$.
- $\lim_{x \rightarrow a} (f(x) \cdot g(x)) = F \cdot G$ — limit of the product is the product of limits.
- If $G \neq 0$ then $\lim_{x \rightarrow a} \frac{f(x)}{g(x)} = \frac{F}{G}$ and, in particular, $\lim_{x \rightarrow a} \frac{1}{g(x)} = \frac{1}{G}$.

Note — be careful with this last one — the denominator cannot be zero.

The above theorem shows that limits interact very simply with arithmetic. If you are asked to find the limit of a sum then the answer is just the sum of the limits. Similarly the limit of a product is just the product of the limits.

How do we apply the above theorem to the rational function? Here is a warm-up example:

Example 2.1.16

You are given two functions f, g (not explicitly) which have the following limits as x approaches 1:

$$\lim_{x \rightarrow 1} f(x) = 3 \qquad \text{and} \qquad \lim_{x \rightarrow 1} g(x) = 2$$

Using the above theorem we can compute:

$$\begin{aligned} \lim_{x \rightarrow 1} 3f(x) &= 3 \times 3 = 9 \\ \lim_{x \rightarrow 1} 3f(x) - g(x) &= 3 \times 3 - 2 = 7 \\ \lim_{x \rightarrow 1} f(x)g(x) &= 3 \times 2 = 6 \\ \lim_{x \rightarrow 1} \frac{f(x)}{f(x) - g(x)} &= \frac{3}{3 - 2} = 3 \end{aligned}$$

Example 2.1.16**Example 2.1.17**

Find $\lim_{x \rightarrow 3} 4x^2 - 1$

We use the arithmetic of limits:

$$\begin{aligned}
 \lim_{x \rightarrow 3} 4x^2 - 1 &= \left(\lim_{x \rightarrow 3} 4x^2 \right) - \lim_{x \rightarrow 3} 1 && \text{difference of limits} \\
 &= \left(\lim_{x \rightarrow 3} 4 \cdot \lim_{x \rightarrow 3} x^2 \right) - \lim_{x \rightarrow 3} 1 && \text{product of limits} \\
 &= 4 \cdot \left(\lim_{x \rightarrow 3} x^2 \right) - 1 && \text{limit of constant} \\
 &= 4 \cdot \left(\lim_{x \rightarrow 3} x \right) \cdot \left(\lim_{x \rightarrow 3} x \right) - 1 && \text{product of limits} \\
 &= 4 \cdot 3 \cdot 3 - 1 && \text{limit of } x \\
 &= 36 - 1 \\
 &= 35
 \end{aligned}$$

Example 2.1.17

This is an excruciating level of detail, but when you first use a theorem, it is a good idea to do things step by step. You can go faster when you are comfortable.

Example 2.1.18

Yet another limit — compute $\lim_{x \rightarrow 2} \frac{x}{x-1}$.

To apply the arithmetic of limits, we need to examine numerator and denominator separately and make sure the limit of the denominator is non-zero. Numerator first:

$$\lim_{x \rightarrow 2} x = 2 \qquad \text{limit of } x$$

and now the denominator:

$$\begin{aligned}
 \lim_{x \rightarrow 2} x - 1 &= \left(\lim_{x \rightarrow 2} x \right) - \left(\lim_{x \rightarrow 2} 1 \right) && \text{difference of limits} \\
 &= 2 - 1 && \text{limit of } x \text{ and limit of constant} = 1
 \end{aligned}$$

Since the limit of the denominator is non-zero we can put it back together to get

$$\begin{aligned}
 \lim_{x \rightarrow 2} \frac{x}{x-1} &= \frac{\lim_{x \rightarrow 2} x}{\lim_{x \rightarrow 2} (x-1)} \\
 &= \frac{2}{1} \\
 &= 2
 \end{aligned}$$

Example 2.1.18

In the next example we show that many different things can happen if the limit of the denominator is zero.

Example 2.1.19 (Be careful with limits of ratios)

We must be careful when computing the limit of a ratio — it is the ratio of the limits except when the limit of the denominator is zero. When the limit of the denominator is zero Theorem 2.1.15 **does not apply** and a few interesting things can happen.

- If the limit of the numerator is non-zero then the limit of the ratio does not exist

$$\lim_{x \rightarrow a} \frac{f(x)}{g(x)} = DNE \quad \text{when } \lim_{x \rightarrow a} f(x) \neq 0 \text{ and } \lim_{x \rightarrow a} g(x) = 0$$

For example, $\lim_{x \rightarrow 0} \frac{1}{x^2} = DNE$.

- If the limit of the numerator is zero then the above theorem does not give us enough information to decide whether or not the limit exists. It is possible that

– the limit does not exist, eg. $\lim_{x \rightarrow 0} \frac{x}{x^2} = \lim_{x \rightarrow 0} \frac{1}{x} = DNE$

– the limit is $\pm\infty$, eg. $\lim_{x \rightarrow 0} \frac{x^2}{x^4} = \lim_{x \rightarrow 0} \frac{1}{x^2} = +\infty$ or $\lim_{x \rightarrow 0} \frac{-x^2}{x^4} = \lim_{x \rightarrow 0} \frac{-1}{x^2} = -\infty$.

– the limit is zero, eg. $\lim_{x \rightarrow 0} \frac{x^2}{x} = 0$

– the limit exists and is non-zero, eg. $\lim_{x \rightarrow 0} \frac{x}{x} = 1$

Now while the above examples are very simple and a little contrived they serve to illustrate the point we are trying to make — be careful if the limit of the denominator is zero.

Example 2.1.19

Example 2.1.20

Let $h(x) = \frac{2x-3}{x^2+5x-6}$ and find its limit as x approaches 2.

Since this is the limit of a ratio, we compute the limit of the numerator and denominator separately. Numerator first:

$$\begin{aligned} \lim_{x \rightarrow 2} 2x - 3 &= \left(\lim_{x \rightarrow 2} 2x \right) - \left(\lim_{x \rightarrow 2} 3 \right) && \text{difference of limits} \\ &= 2 \cdot \left(\lim_{x \rightarrow 2} x \right) - 3 && \text{product of limits and limit of constant} \\ &= 2 \cdot 2 - 3 && \text{limits of } x \\ &= 1 \end{aligned}$$

Denominator next:

$$\begin{aligned}\lim_{x \rightarrow 2} x^2 + 5x - 6 &= \left(\lim_{x \rightarrow 2} x^2 \right) + \left(\lim_{x \rightarrow 2} 5x \right) - \left(\lim_{x \rightarrow 2} 6 \right) && \text{sum of limits} \\ &= \left(\lim_{x \rightarrow 2} x \right) \cdot \left(\lim_{x \rightarrow 2} x \right) + 5 \cdot \left(\lim_{x \rightarrow 2} x \right) - 6 && \text{product of limits and limit of constant} \\ &= 2 \cdot 2 + 5 \cdot 2 - 6 && \text{limits of } x \\ &= 8\end{aligned}$$

Since the limit of the denominator is non-zero, we can obtain our result by taking the ratio of the separate limits.

$$\lim_{x \rightarrow 2} \frac{2x - 3}{x^2 + 5x - 6} = \frac{\lim_{x \rightarrow 2} 2x - 3}{\lim_{x \rightarrow 2} x^2 + 5x - 6} = \frac{1}{8}$$

The above works out quite simply. However, if we were to take the limit as $x \rightarrow 1$ then things are a bit harder. The limit of the numerator is:

$$\lim_{x \rightarrow 1} 2x - 3 = 2 \cdot 1 - 3 = -1$$

(we have not listed all the steps). And the limit of the denominator is

$$\lim_{x \rightarrow 1} x^2 + 5x - 6 = 1 \cdot 1 + 5 - 6 = 0$$

Since the limit of the numerator is non-zero, while the limit of the denominator is zero, the limit of the ratio does not exist.

$$\lim_{x \rightarrow 1} \frac{2x - 3}{x^2 + 5x - 6} = DNE$$

Example 2.1.20

It is **IMPORTANT TO NOTE** that it is not correct to write

$$\lim_{x \rightarrow 1} \frac{2x - 3}{x^2 + 5x - 6} = \frac{-1}{0} = DNE$$

Because we can only write

$$\lim_{x \rightarrow a} \frac{f(x)}{g(x)} = \frac{\lim_{x \rightarrow a} f(x)}{\lim_{x \rightarrow a} g(x)} = \text{something}$$

when the limit of the denominator is non-zero (see Example 2.1.19 above).

With a little care you can use the arithmetic of limits to obtain the following rules for limits of powers of functions and limits of roots of functions:

Theorem 2.1.21 (More arithmetic of limits — powers and roots).

Let n be a positive integer, let $a \in \mathbb{R}$ and let f be a function so that

$$\lim_{x \rightarrow a} f(x) = F$$

for some real number F . Then the following holds

$$\lim_{x \rightarrow a} (f(x))^n = \left(\lim_{x \rightarrow a} f(x) \right)^n = F^n$$

so that the limit of a power is the power of the limit. Similarly, if

- n is an even number and $F > 0$, or
- n is an odd number and F is any real number

then

$$\lim_{x \rightarrow a} (f(x))^{1/n} = \left(\lim_{x \rightarrow a} f(x) \right)^{1/n} = F^{1/n}$$

More generally⁷, if $F > 0$ and p is any real number,

$$\lim_{x \rightarrow a} (f(x))^p = \left(\lim_{x \rightarrow a} f(x) \right)^p = F^p$$

Notice that we have to be careful when taking roots of limits that might be negative numbers. To see why, consider the case $n = 2$, the limit

$$\begin{aligned} \lim_{x \rightarrow 4} x^{1/2} &= 4^{1/2} = 2 \\ \lim_{x \rightarrow 4} (-x)^{1/2} &= (-4)^{1/2} = \text{not a real number} \end{aligned}$$

In order to evaluate such limits properly we need to use complex numbers which are beyond the scope of this text.

Also note that the notation $x^{1/2}$ refers to the *positive* square root of x . While 2 and (-2) are both numbers whose squares are 4, the notation $4^{1/2}$ means 2. This is something we must be careful of⁸.

So again — let us do a few examples and carefully note what we are doing.

Example 2.1.22

7 You may not know the definition of the power b^p when p is not a rational number, so here it is. If $b > 0$ and p is any real number, then b^p is the limit of b^r as r approaches p through rational numbers. We won't do so here, but it is possible to prove that the limit exists.

8 Like ending sentences in prepositions — “This is something up with which we will not put.” This quote is attributed to Churchill though there is some dispute as to whether or not he really said it.

$$\begin{aligned}\lim_{x \rightarrow 2} (4x^2 - 3)^{1/3} &= \left(\left(\lim_{x \rightarrow 2} 4x^2 \right) - \left(\lim_{x \rightarrow 2} 3 \right) \right)^{1/3} \\ &= (4 \cdot 2^2 - 3)^{1/3} \\ &= (16 - 3)^{1/3} \\ &= 13^{1/3}\end{aligned}$$

Example 2.1.22

By combining the last few theorems we can make the evaluation of limits of polynomials and rational functions much easier:

Theorem 2.1.23 (Limits of polynomials and rational functions).

Let $a \in \mathbb{R}$, let $P(x)$ be a polynomial and let $R(x)$ be a rational function. Then

$$\lim_{x \rightarrow a} P(x) = P(a)$$

and provided $R(x)$ is defined at $x = a$ then

$$\lim_{x \rightarrow a} R(x) = R(a)$$

If $R(x)$ is not defined at $x = a$ then we are not able to apply this result.

So the previous examples are now much easier to compute:

$$\begin{aligned}\lim_{x \rightarrow 2} \frac{2x - 3}{x^2 + 5x - 6} &= \frac{4 - 3}{4 + 10 - 6} = \frac{1}{8} \\ \lim_{x \rightarrow 2} (4x^2 - 1) &= 16 - 1 = 15 \\ \lim_{x \rightarrow 2} \frac{x}{x - 1} &= \frac{2}{2 - 1} = 2\end{aligned}$$

It is clear that limits of polynomials are very easy, while those of rational functions are easy except when the denominator might go to zero. We have seen examples where the resulting limit does not exist, and some where it does. We now work to explain this more systematically. The following example demonstrates that it is sometimes possible to take the limit of a rational function to a point at which the denominator is zero. Indeed we must be able to do exactly this in order to be able to define derivatives in the next chapter.

Example 2.1.24

Consider the limit

$$\lim_{x \rightarrow 1} \frac{x^3 - x^2}{x - 1}.$$

If we try to apply the arithmetic of limits then we compute the limits of the numerator and denominator separately

$$\lim_{x \rightarrow 1} x^3 - x^2 = 1 - 1 = 0 \quad (2.1.1)$$

$$\lim_{x \rightarrow 1} x - 1 = 1 - 1 = 0 \quad (2.1.2)$$

Since the denominator is zero, we cannot apply our theorem and we are, for the moment, stuck. However, there is more that we can do here — the hint is that the numerator and denominator *both* approach zero as x approaches 1. This means that there might be something we can cancel.

So let us play with the expression a little more before we take the limit:

$$\frac{x^3 - x^2}{x - 1} = \frac{x^2(x - 1)}{x - 1} = x^2 \quad \text{provided } x \neq 1.$$

So what we really have here is the following function

$$\frac{x^3 - x^2}{x - 1} = \begin{cases} x^2 & x \neq 1 \\ \text{undefined} & x = 1 \end{cases}$$

If we plot the above function the graph looks exactly the same as $y = x^2$ except that the function is not defined at $x = 1$ (since at $x = 1$ both numerator and denominator are zero).

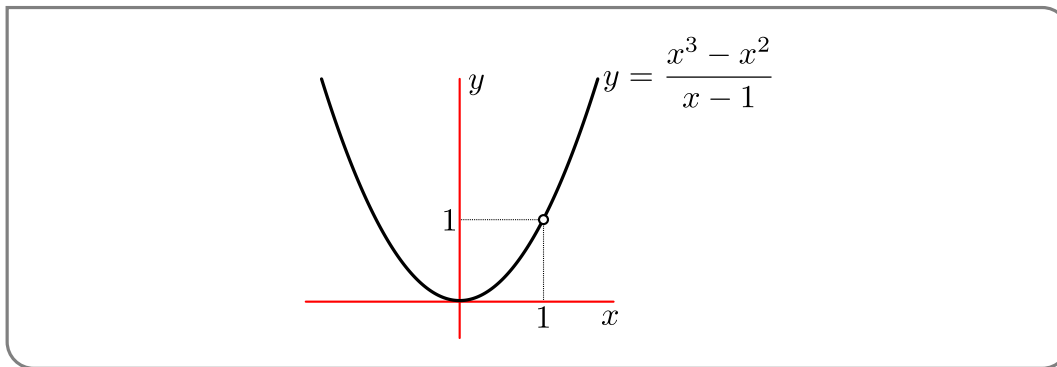

When we compute a limit as $x \rightarrow a$, the value of the function exactly at $x = a$ is irrelevant. We only care what happens to the function as we bring x very close to a . So for the above problem we can write

$$\frac{x^3 - x^2}{x - 1} = x^2 \quad \text{when } x \text{ is close to } 1 \text{ but not at } x = 1$$

So the limit as $x \rightarrow 1$ of the function is the same as the limit $\lim_{x \rightarrow 1} x^2$ since the functions are the same except exactly at $x = 1$. By this reasoning we get

$$\lim_{x \rightarrow 1} \frac{x^3 - x^2}{x - 1} = \lim_{x \rightarrow 1} x^2 = 1$$

Example 2.1.24

The reasoning in the above example can be made more general:

Theorem 2.1.25.

If $f(x) = g(x)$ except when $x = a$ then $\lim_{x \rightarrow a} f(x) = \lim_{x \rightarrow a} g(x)$ provided the limit of g exists.

How do we know when to use this theorem? The big clue is that when we try to compute the limit in a naive way, we end up with $\frac{0}{0}$. We know that $\frac{0}{0}$ does not make sense, but it is an indication that there *might* be a common factor between numerator and denominator that can be cancelled. In the previous example, this common factor was $(x - 1)$.

Example 2.1.26

Using this idea, compute

$$\lim_{h \rightarrow 0} \frac{(1+h)^2 - 1}{h}$$

- First we should check that we cannot just substitute $h = 0$ into this — clearly we cannot because the denominator would be 0.
- But we should also check the numerator to see if we have $\frac{0}{0}$, and we see that the numerator gives us $1 - 1 = 0$.
- Thus we have a hint that there is a common factor that we might be able to cancel. So now we look for the common factor and try to cancel it.

$$\begin{aligned} \frac{(1+h)^2 - 1}{h} &= \frac{1 + 2h + h^2 - 1}{h} && \text{expand} \\ &= \frac{2h + h^2}{h} = \frac{h(2+h)}{h} && \text{factor and then cancel} \\ &= 2 + h \end{aligned}$$

- Thus we really have that

$$\frac{(1+h)^2 - 1}{h} = \begin{cases} 2+h & h \neq 0 \\ \text{undefined} & h = 0 \end{cases}$$

and because of this

$$\begin{aligned} \lim_{h \rightarrow 0} \frac{(1+h)^2 - 1}{h} &= \lim_{h \rightarrow 0} 2 + h \\ &= 2 \end{aligned}$$

Example 2.1.26

We have written everything out in great detail here — way more than is required for a solution to such a problem. Let us do it again a little more succinctly.



Example 2.1.27

Compute the following limit:

$$\lim_{h \rightarrow 0} \frac{(1+h)^2 - 1}{h}$$

If we try to use the arithmetic of limits, then we see that the limit of the numerator and the limit of the denominator are both zero. Hence we should try to factor them and cancel any common factor. This gives

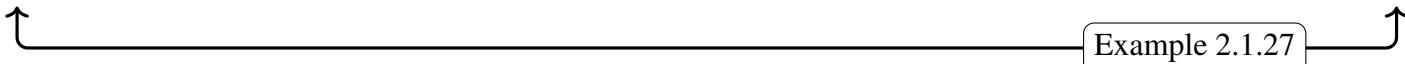
$$\begin{aligned} \lim_{h \rightarrow 0} \frac{(1+h)^2 - 1}{h} &= \lim_{h \rightarrow 0} \frac{1 + 2h + h^2 - 1}{h} \\ &= \lim_{h \rightarrow 0} 2 + h \\ &= 2 \end{aligned}$$

Example 2.1.27

Notice that even though we did this example carefully above, we have still written some text in our working explaining what we have done. You should always think about the reader and, if in doubt, put in more explanation rather than less.

2.1.2 ►► Limits at infinity

Up until this point we have discussed what happens to a function as we move its input x closer and closer to a particular point a . For a great many applications of limits we need to understand what happens to a function when its input becomes extremely large — for example what happens to a population at a time far in the future.

The definition of a limit at infinity has a similar flavour to the definition of limits at finite points that we saw above, but the details are a little different. We also need to distinguish between positive and negative infinity. As x becomes very large and positive it moves off towards $+\infty$ but when it becomes very large and negative it moves off towards $-\infty$.

Again we give an informal definition; the full formal definition is beyond the scope of this course.

Definition 2.1.28 (Limits at infinity — informal).

We write

$$\lim_{x \rightarrow \infty} f(x) = L$$

when the value of the function $f(x)$ gets closer and closer to L as we make x larger and larger and positive.

Similarly we write

$$\lim_{x \rightarrow -\infty} f(x) = L$$

when the value of the function $f(x)$ gets closer and closer to L as we make x larger and larger and negative.

Example 2.1.29

Consider the two functions depicted below

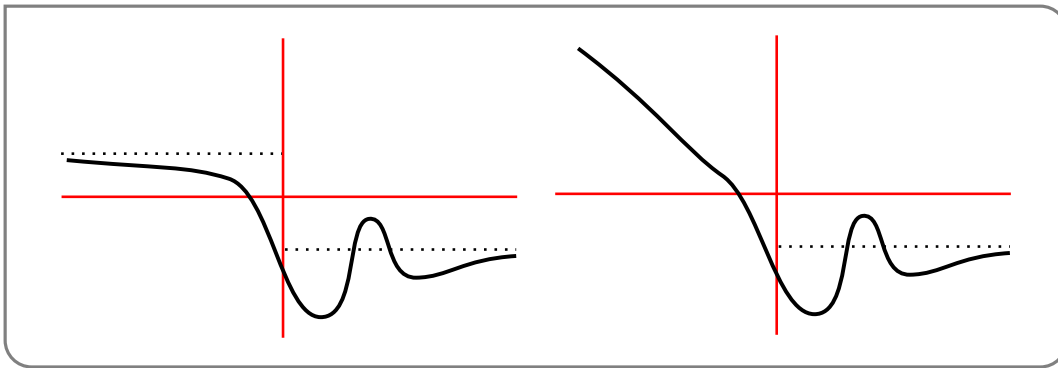

The dotted horizontal lines indicate the behaviour as x becomes very large. The function on the left has limits as $x \rightarrow \infty$ and as $x \rightarrow -\infty$ since the function “settles down” to a particular value. On the other hand, the function on the right does not have a limit as $x \rightarrow -\infty$ since the function just keeps getting bigger and bigger.

Example 2.1.29

Just as was the case for limits as $x \rightarrow a$ we will start with two very simple building blocks and build other limits from those.

Theorem 2.1.30.

Let $c \in \mathbb{R}$ then the following limits hold

$$\lim_{x \rightarrow \infty} c = c$$

$$\lim_{x \rightarrow \infty} \frac{1}{x} = 0$$

$$\lim_{x \rightarrow -\infty} c = c$$

$$\lim_{x \rightarrow -\infty} \frac{1}{x} = 0$$

Again, these limits interact nicely with standard arithmetic:

Theorem 2.1.31 (Arithmetic of limits at infinity).

Let $f(x), g(x)$ be two functions for which the limits

$$\lim_{x \rightarrow \infty} f(x) = F \qquad \lim_{x \rightarrow \infty} g(x) = G$$

exist. Then the following limits hold

$$\lim_{x \rightarrow \infty} f(x) \pm g(x) = F \pm G$$

$$\lim_{x \rightarrow \infty} f(x)g(x) = FG$$

$$\lim_{x \rightarrow \infty} \frac{f(x)}{g(x)} = \frac{F}{G} \qquad \text{provided } G \neq 0$$

and for real numbers p

$$\lim_{x \rightarrow \infty} f(x)^p = F^p \qquad \text{provided } F^p \text{ and } f(x)^p \text{ are defined for all } x$$

The analogous results hold for limits to $-\infty$.

Note that, as was the case in Theorem 2.1.21, we need a little extra care with powers of functions. We must avoid taking square roots of negative numbers, or indeed any even root of a negative number⁹.

Hence we have for all rational $r > 0$

$$\lim_{x \rightarrow \infty} \frac{1}{x^r} = 0$$

but we have to be careful with

$$\lim_{x \rightarrow -\infty} \frac{1}{x^r} = 0$$

This is only true if the denominator of r is not an even number¹⁰.

For example

- $\lim_{x \rightarrow \infty} \frac{1}{x^{1/2}} = 0$, but $\lim_{x \rightarrow -\infty} \frac{1}{x^{1/2}}$ does not exist, because $x^{1/2}$ is not defined for $x < 0$.

- On the other hand, $x^{4/3}$ is defined for negative values of x and $\lim_{x \rightarrow -\infty} \frac{1}{x^{4/3}} = 0$.

⁹ To be more precise, there is no real number x so that $x^{\text{even power}}$ is a negative number. Hence we cannot take the even-root of a negative number and express it as a real number. This is precisely what complex numbers allow us to do, but alas, there is not space in the course for us to explore them.

¹⁰ where we write $r = \frac{p}{q}$ with p, q integers with no common factors. For example, $r = \frac{6}{14}$ should be written as $r = \frac{3}{7}$ when considering this rule.

Our first application of limits at infinity will be to examine the behaviour of a rational function for very large x . To do this we use a “trick”.

Example 2.1.32

Compute the following limit:

$$\lim_{x \rightarrow \infty} \frac{x^2 - 3x + 4}{3x^2 + 8x + 1}$$

As x becomes very large, it is the x^2 term that will dominate in both the numerator and denominator and the other bits become irrelevant. (This is the asymptotic reasoning you’ve seen earlier.) That is, for very large x , x^2 is much much larger than x or any constant. So we pull out these dominant parts

$$\begin{aligned} \frac{x^2 - 3x + 4}{3x^2 + 8x + 1} &= \frac{x^2 \left(1 - \frac{3}{x} + \frac{4}{x^2}\right)}{x^2 \left(3 + \frac{8}{x} + \frac{1}{x^2}\right)} \\ &= \frac{1 - \frac{3}{x} + \frac{4}{x^2}}{3 + \frac{8}{x} + \frac{1}{x^2}} \end{aligned} \quad \text{remove the common factors}$$

$$\begin{aligned} \lim_{x \rightarrow \infty} \frac{x^2 - 3x + 4}{3x^2 + 8x + 1} &= \lim_{x \rightarrow \infty} \frac{1 - \frac{3}{x} + \frac{4}{x^2}}{3 + \frac{8}{x} + \frac{1}{x^2}} \\ &= \frac{\lim_{x \rightarrow \infty} \left(1 - \frac{3}{x} + \frac{4}{x^2}\right)}{\lim_{x \rightarrow \infty} \left(3 + \frac{8}{x} + \frac{1}{x^2}\right)} \quad \text{arithmetic of limits} \\ &= \frac{\lim_{x \rightarrow \infty} 1 - \lim_{x \rightarrow \infty} \frac{3}{x} + \lim_{x \rightarrow \infty} \frac{4}{x^2}}{\lim_{x \rightarrow \infty} 3 + \lim_{x \rightarrow \infty} \frac{8}{x} + \lim_{x \rightarrow \infty} \frac{1}{x^2}} \quad \text{more arithmetic of limits} \\ &= \frac{1 + 0 + 0}{3 + 0 + 0} = \frac{1}{3}. \end{aligned}$$

Example 2.1.32

The following one gets a little harder.

Example 2.1.33

Find the limit as $x \rightarrow \infty$ of $\frac{\sqrt{4x^2+1}}{5x-1}$.

We use the same trick — try to work out what is the biggest term in the numerator and denominator and pull it to one side.

- The denominator is dominated by $5x$.
- The biggest contribution to the numerator comes from the $4x^2$ inside the square-root. When we pull x^2 outside the square-root it becomes x , so the numerator is dominated by $x \cdot \sqrt{4} = 2x$

- To see this more explicitly rewrite the numerator

$$\sqrt{4x^2 + 1} = \sqrt{x^2(4 + 1/x^2)} = \sqrt{x^2} \sqrt{4 + 1/x^2} = x\sqrt{4 + 1/x^2}.$$

- Thus the limit as $x \rightarrow \infty$ is

$$\begin{aligned} \lim_{x \rightarrow \infty} \frac{\sqrt{4x^2 + 1}}{5x - 1} &= \lim_{x \rightarrow \infty} \frac{x\sqrt{4 + 1/x^2}}{x(5 - 1/x)} \\ &= \lim_{x \rightarrow \infty} \frac{\sqrt{4 + 1/x^2}}{5 - 1/x} \\ &= \frac{2}{5}. \end{aligned}$$

Example 2.1.33

Now let us also think about the limit of the same function, $\frac{\sqrt{4x^2+1}}{5x-1}$, as $x \rightarrow -\infty$. There is something subtle going on because of the square-root. First consider the function¹¹

$$h(t) = \sqrt{t^2}.$$

Evaluating this at $t = 7$ gives

$$h(7) = \sqrt{7^2} = \sqrt{49} = 7.$$

We'll get much the same thing for any $t \geq 0$. For any $t \geq 0$, $h(t) = \sqrt{t^2}$ returns exactly t . However now consider the function at $t = -3$

$$h(-3) = \sqrt{(-3)^2} = \sqrt{9} = 3 = -(-3);$$

that is, the function is returning -1 times the input.

This is because when we defined $\sqrt{}$, we defined it to be the *positive* square-root. i.e. the function \sqrt{t} can never return a negative number. So being more careful

$$h(t) = \sqrt{t^2} = |t|,$$

where the $|t|$ is the absolute value of t . You are perhaps used to thinking of absolute value as “remove the minus sign”, but this is not quite correct. Let's sketch the function:

Figure 2.1.2.

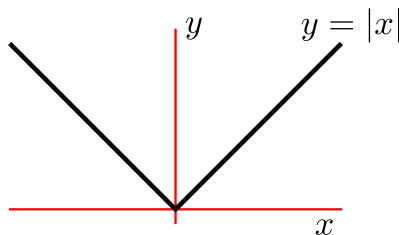

¹¹ Just to change things up let's use t and $h(t)$ instead of the ubiquitous x and $f(x)$.

It is a piecewise function defined by

$$|x| = \begin{cases} x & x \geq 0 \\ -x & x < 0. \end{cases}$$

Hence our function $h(t)$ is really

$$h(t) = \sqrt{t^2} = \begin{cases} t & t \geq 0 \\ -t & t < 0 \end{cases}$$

so that when we evaluate $h(-7)$ it is

$$h(-7) = \sqrt{(-7)^2} = \sqrt{49} = 7 = -(-7).$$

We are now ready to examine the limit as $x \rightarrow -\infty$ in our previous example. Mostly it is copy and paste from above.

Example 2.1.34

Find the limit as $x \rightarrow -\infty$ of $\frac{\sqrt{4x^2+1}}{5x-1}$

We use the same trick — try to work out what is the biggest term in the numerator and denominator and pull it to one side. Since we are taking the limit as $x \rightarrow -\infty$ we should think of x as a large negative number.

- The denominator is dominated by $5x$.
- The biggest contribution to the numerator comes from the $4x^2$ inside the square-root. When we pull the x^2 outside a square-root it becomes $|x| = -x$ (since we are taking the limit as $x \rightarrow -\infty$), so the numerator is dominated by $-x \cdot \sqrt{4} = -2x$
- To see this more explicitly rewrite the numerator

$$\begin{aligned} \sqrt{4x^2+1} &= \sqrt{x^2(4+1/x^2)} = \sqrt{x^2}\sqrt{4+1/x^2} \\ &= |x|\sqrt{4+1/x^2} \\ &= -x\sqrt{4+1/x^2} \end{aligned}$$

and since $x < 0$ we have

- Thus the limit as $x \rightarrow -\infty$ is

$$\begin{aligned} \lim_{x \rightarrow -\infty} \frac{\sqrt{4x^2+1}}{5x-1} &= \lim_{x \rightarrow -\infty} \frac{-x\sqrt{4+1/x^2}}{x(5-1/x)} \\ &= \lim_{x \rightarrow -\infty} \frac{-\sqrt{4+1/x^2}}{5-1/x} \\ &= \frac{2}{5}. \end{aligned}$$

Example 2.1.34

So the limit as $x \rightarrow -\infty$ is almost the same but we gain a minus sign. This is **definitely not** the case in general — you have to think about each example separately.

Here is a sketch of the function in question.

Figure 2.1.3.

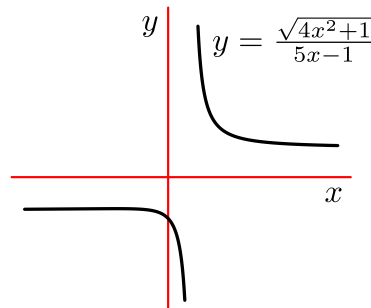

Example 2.1.35

Compute the following limit:

$$\lim_{x \rightarrow \infty} (x^{7/5} - x)$$

From our asymptotic reasoning, we know the higher-power power function will dominate for large values of x . So, although both $x^{7/5}$ and x grow without bound as $x \rightarrow \infty$, the first term will be much bigger. So, we expect $\lim_{x \rightarrow \infty} (x^{7/5} - x) = \infty$.

That's a fine way of computing the limit, but for interest, let's see how it would go using arithmetic of limits. In this case we *cannot* use the arithmetic of limits to write this as

$$\begin{aligned} \lim_{x \rightarrow \infty} (x^{7/5} - x) &= \left(\lim_{x \rightarrow \infty} x^{7/5} \right) - \left(\lim_{x \rightarrow \infty} x \right) \\ &= \infty - \infty \end{aligned}$$

because the limits do not exist. We can only use the limit laws when the limits exist. So we should go back and think some more.

When x is very large, $x^{7/5} = x \cdot x^{2/5}$ will be much larger than x , so the $x^{7/5}$ term will dominate the x term. So factor out $x^{7/5}$ and rewrite it as

$$x^{7/5} - x = x^{7/5} \left(1 - \frac{1}{x^{2/5}} \right)$$

Consider what happens to each of the factors as $x \rightarrow \infty$

- For large x , $x^{7/5} > x$ (this is actually true for any $x > 1$). In the limit as $x \rightarrow +\infty$, x becomes arbitrarily large and positive, and $x^{7/5}$ must be bigger still, so it follows that

$$\lim_{x \rightarrow \infty} x^{7/5} = +\infty.$$

- On the other hand, $(1 - x^{-2/5})$ becomes closer and closer to 1 — we can use the arithmetic of limits to write this as

$$\lim_{x \rightarrow \infty} (1 - x^{-2/5}) = \lim_{x \rightarrow \infty} 1 - \lim_{x \rightarrow \infty} x^{-2/5} = 1 - 0 = 1.$$

So the product of these two factors will be come larger and larger (and positive) as x moves off to infinity. Hence we have

$$\lim_{x \rightarrow \infty} x^{7/5} \left(1 - 1/x^{2/5}\right) = +\infty.$$



Example 2.1.35

But remember $+\infty$ and $-\infty$ are not numbers; the last equation in the example is shorthand for “the function becomes arbitrarily large”.

In the previous section we saw that finite limits and arithmetic interact very nicely (see Theorems 2.1.15 and 2.1.21). This enabled us to compute the limits of more complicated function in terms of simpler ones. When limits of functions go to plus or minus infinity we are quite a bit more restricted in what we can deduce. The next theorem states some results concerning the sum, difference, ratio and product of infinite limits — unfortunately in many cases we cannot make general statements and the results will depend on the details of the problem at hand.

Theorem 2.1.36 (Arithmetic of infinite limits).

Let $a, c, H \in \mathbb{R}$ and let f, g, h be functions defined in an interval around a (but they need not be defined at $x = a$), so that

$$\lim_{x \rightarrow a} f(x) = +\infty$$

$$\lim_{x \rightarrow a} g(x) = +\infty$$

$$\lim_{x \rightarrow a} h(x) = H$$

- $\lim_{x \rightarrow a} (f(x) + g(x)) = +\infty$
- $\lim_{x \rightarrow a} (f(x) + h(x)) = +\infty$
- $\lim_{x \rightarrow a} (f(x) - g(x))$ undetermined
- $\lim_{x \rightarrow a} (f(x) - h(x)) = +\infty$
- $\lim_{x \rightarrow a} cf(x) = \begin{cases} +\infty & c > 0 \\ 0 & c = 0 \\ -\infty & c < 0 \end{cases}$
- $\lim_{x \rightarrow a} (f(x) \cdot g(x)) = +\infty$.
- $\lim_{x \rightarrow a} f(x)h(x) = \begin{cases} +\infty & H > 0 \\ -\infty & H < 0 \\ \text{undetermined} & H = 0 \end{cases}$
- $\lim_{x \rightarrow a} \frac{f(x)}{g(x)}$ undetermined
- $\lim_{x \rightarrow a} \frac{f(x)}{h(x)} = \begin{cases} +\infty & H > 0 \\ -\infty & H < 0 \\ \text{undetermined} & H = 0 \end{cases}$
- $\lim_{x \rightarrow a} \frac{h(x)}{f(x)} = 0$
- $\lim_{x \rightarrow a} f(x)^p = \begin{cases} +\infty & p > 0 \\ 0 & p < 0 \\ 1 & p = 0 \end{cases}$

Note that by “undetermined” we mean that the limit may or may not exist, but cannot be determined from the information given in the theorem. See Example 2.1.19 for an example of what we mean by “undetermined”. Additionally consider the following example.

Example 2.1.37

Consider the following 3 functions:

$$f(x) = x^{-2}$$

$$g(x) = 2x^{-2}$$

$$h(x) = x^{-2} - 1.$$

Their limits as $x \rightarrow 0$ are:

$$\lim_{x \rightarrow 0} f(x) = +\infty$$

$$\lim_{x \rightarrow 0} g(x) = +\infty$$

$$\lim_{x \rightarrow 0} h(x) = +\infty.$$

Say we want to compute the limit of the difference of two of the above functions as $x \rightarrow 0$. Then the previous theorem cannot help us. This is not because it is too weak, rather it is because the difference of two infinite limits can be, either plus infinity, minus infinity or some finite number depending on the details of the problem. For example,

$$\lim_{x \rightarrow 0} (f(x) - g(x)) = \lim_{x \rightarrow 0} -x^{-2} = -\infty$$

$$\lim_{x \rightarrow 0} (f(x) - h(x)) = \lim_{x \rightarrow 0} 1 = 1$$

$$\lim_{x \rightarrow 0} (g(x) - h(x)) = \lim_{x \rightarrow 0} x^{-2} + 1 = +\infty$$

Example 2.1.37

2.2 ▲ Asymptotes

Learning Objectives

- Evaluate limits of polynomial, rational, trigonometric, exponential, and logarithmic functions.
- Explain using both informal language and the language of limits what it means for a function to have a horizontal or vertical asymptote.
- Given a simple function, find its vertical and horizontal asymptotes by asymptotic reasoning or by taking limits.
- Explain why it is not true that a function cannot cross its horizontal asymptote.

Definition 2.2.1.

Let $f(x)$ be a function. If $\lim_{x \rightarrow \infty} f(x) = L$ OR $\lim_{x \rightarrow -\infty} f(x) = L$, for some real number L , then we say the line $y = L$ is a horizontal asymptote of $f(x)$.

Example 2.2.2

Consider the function $f(x) = \frac{3x^4}{1+x^4}$, pictured below.

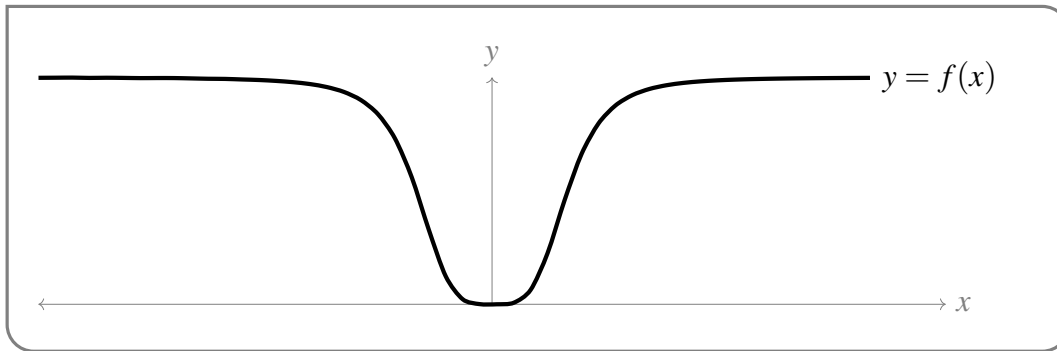

For large positive and large negative values of x , the function looks nearly flat. To investigate this ‘flatness,’ we can take limits at infinity. This can be done using algebra, or asymptotes.

Option 1, algebra:

$$\begin{aligned}\lim_{x \rightarrow \infty} \frac{3x^4}{1+x^4} &= \lim_{x \rightarrow \infty} \frac{3x^4}{1+x^4} \cdot \frac{1/x^4}{1/x^4} \\ &= \lim_{x \rightarrow \infty} \frac{3}{\frac{1}{x^4} + 1} \\ &= \frac{3}{0+1} = 3\end{aligned}$$

That is: as x gets larger and larger, $f(x)$ gets closer and closer to 3.

The computation is similar for $\lim_{x \rightarrow -\infty} f(x)$.

Option 2, asymptotics: Let’s consider very large positive values of x . The denominator $1+x^4$ behaves much like x^4 when $|x|$ is large, so the entire function behaves much like $\frac{3x^4}{x^4}$, which is just the constant 3. That is: for very large positive values of x , the function looks quite a lot like the horizontal line $y = 3$.

The computation is similar for $\lim_{x \rightarrow -\infty} f(x)$.

So, this function has a horizontal asymptote, $y = 3$. This is often emphasized in a sketch with dashed lines.

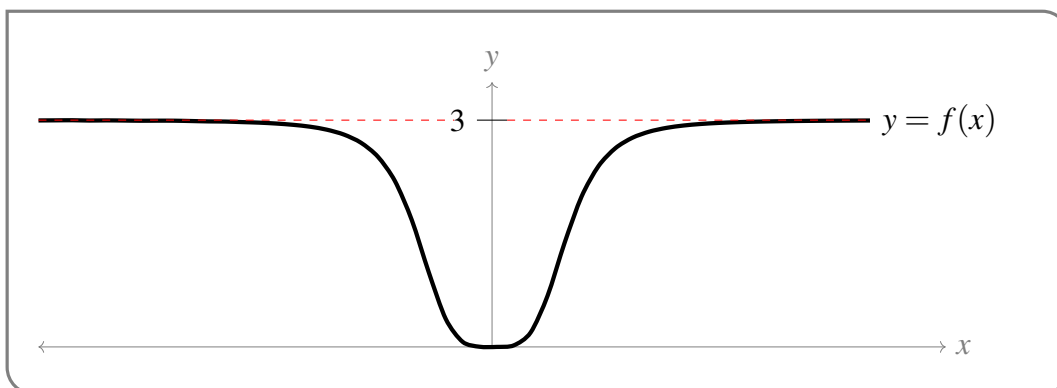

Example 2.2.2

Example 2.2.3 (Horizontal asymptotes of e^x)**Question:** Does e^x have any horizontal asymptotes?**Solution:** We should know the following two limits by heart:

$$\lim_{x \rightarrow -\infty} e^x = 0 \quad \text{and} \quad \lim_{x \rightarrow \infty} e^x = \infty$$

Since 0 is a real number, we see that e^x has a horizontal asymptote at $y = 0$. Since ∞ is *not* a real number, $y = 0$ is the *only* horizontal asymptote of e^x .

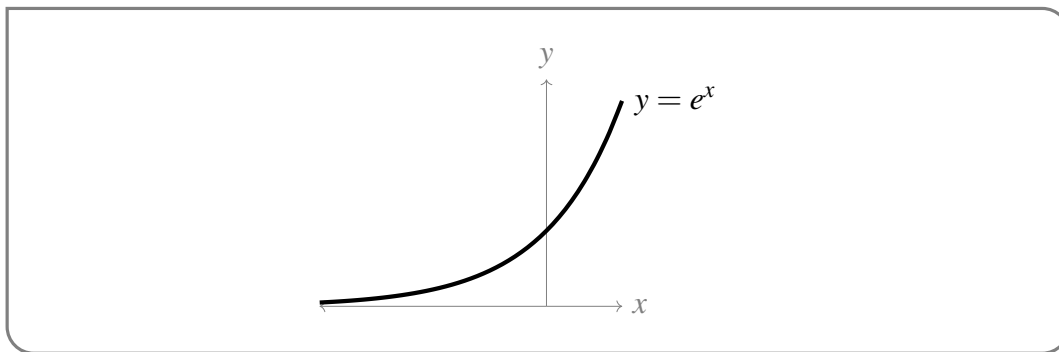

Example 2.2.3

Example 2.2.4 (Functions that cross their horizontal asymptote)

In examples 2.2.2 and 2.2.3, the function never actually takes on the value of its horizontal asymptote. There is no real number x for which $\frac{3x^4}{1+x^4} = 3$, and there is no real number x for which $e^x = 0$. However, there is no reason why a function in general can't take on the value of its horizontal asymptote. We'll show three examples below, of increasing complexity.

First example: A constant function is equal to its horizontal asymptote everywhere.

For example, consider $f(x) = 2$, shown below. Since $\lim_{x \rightarrow \infty} f(x) = 2$, $y = 2$ is a horizontal asymptote. There are lots of real numbers x (in fact: all of them) where $f(x) = 2$.

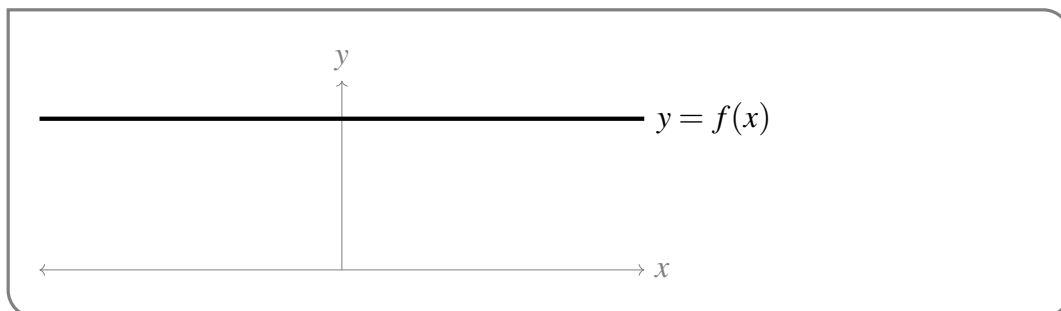

Second example: A function might take on the value of its horizontal asymptote while the function is busy not pretending to be constant.

A function such as $g(x) = \frac{x}{1+x^2}$ has a horizontal asymptote of $y = 0$ both to the left, and to the right:

$$\lim_{x \rightarrow -\infty} \frac{x}{1+x^2} = 0 \quad \text{and} \quad \lim_{x \rightarrow \infty} \frac{x}{1+x^2} = 0$$

That is, when x is very large (positive or negative) $g(x)$ is nearly constant. However, $g(x)$ is not ‘nearly constant’ *everywhere*. When x is close to 0, $g(x)$ moves around quite a bit. And, at the origin, we just so happen to have $g(0) = 0$.

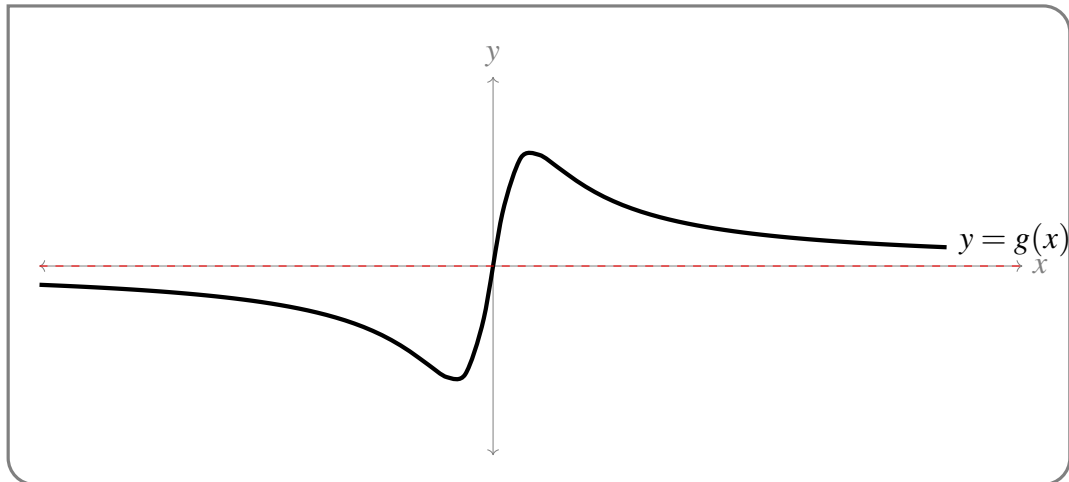

Third example: A function might cross its horizontal asymptote infinitely many times.

Consider $h(x) = \frac{\sin x}{x}$. As $|x|$ grows larger and larger, the *magnitude*, or absolute value, of $h(x)$ shrinks to 0:

$$\lim_{x \rightarrow -\infty} \frac{\sin x}{x} = 0 \quad \text{and} \quad \lim_{x \rightarrow \infty} \frac{\sin x}{x} = 0$$

However, the *sign* of the function changes endlessly: it’s positive for $0 < x < \pi$, negative for $\pi < x < 2\pi$, positive again for $2\pi < x < 3\pi$, etc. That leads to an oscillating behaviour. In particular, $h(x) = 0$ when x is a nonzero integer multiple of π .

Remark: the oscillating behaviour in the sketch below has been exaggerated. In a more accurate sketch, $h(x)$ quickly appears indistinguishable from 0.

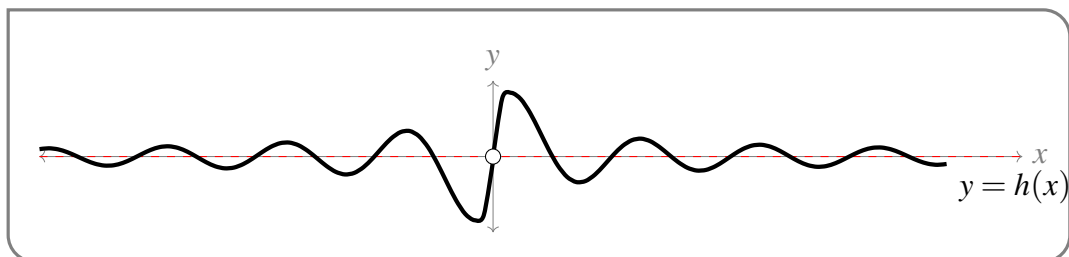

Example 2.2.4

The counterpart to the horizontal asymptote is, not surprisingly, the vertical asymptote.

Definition 2.2.5.

Let a be a real number and let $f(x)$ be a function. We say $f(x)$ has a vertical asymptote at a if at least one of the following is true:

- $\lim_{x \rightarrow a} f(x) = \infty$, or $\lim_{x \rightarrow a} f(x) = -\infty$;
- $\lim_{x \rightarrow a^-} f(x) = \infty$, or $\lim_{x \rightarrow a^-} f(x) = -\infty$; or
- $\lim_{x \rightarrow a^+} f(x) = \infty$, or $\lim_{x \rightarrow a^+} f(x) = -\infty$.

That is, a function has a vertical asymptote where it has an infinite discontinuity (see section 2.3 for more about continuity).

Example 2.2.6 (Symmetrical vertical asymptote)

The function $y = \frac{1}{x^2}$ has a vertical asymptote at $x = 0$, because $\lim_{x \rightarrow 0} \frac{1}{x^2} = \infty$.

(This function also has a horizontal asymptote: $y = 0$.)

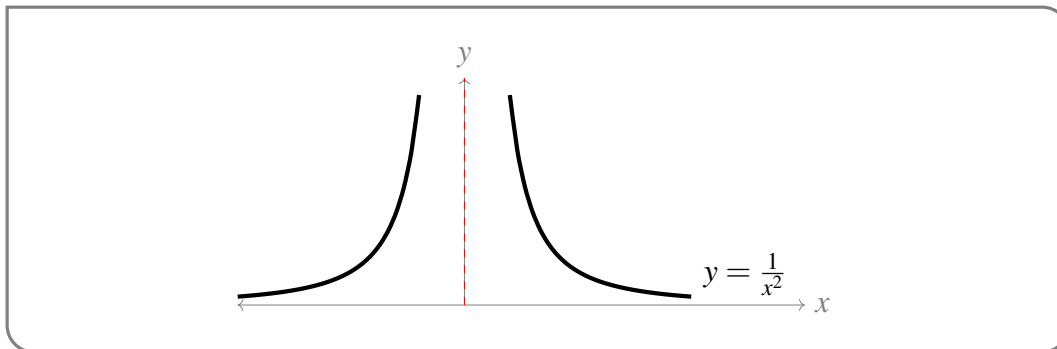
**Example 2.2.6****Example 2.2.7 (Asymmetrical vertical asymptote)**

The function $y = \frac{1}{x}$ has a vertical asymptote at $x = 0$, because $\lim_{x \rightarrow 0^+} \frac{1}{x} = \infty$ and $\lim_{x \rightarrow 0^-} \frac{1}{x} = -\infty$.

(This function also has a horizontal asymptote at $y = 0$.)

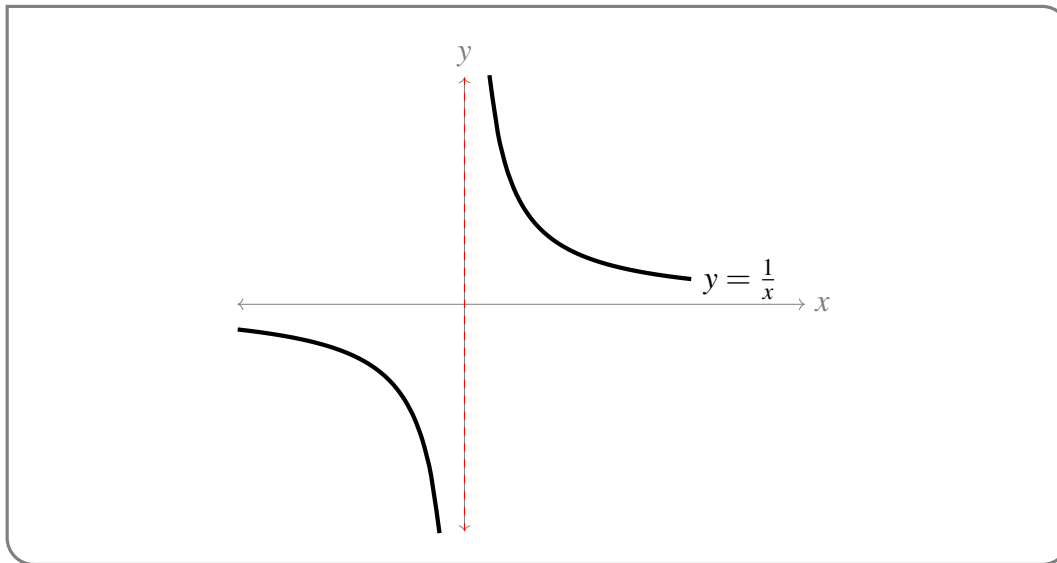

Example 2.2.7

Example 2.2.8 (One-sided vertical asymptote)

The function $y = \log x$ has a vertical asymptote at $x = 0$, because $\lim_{x \rightarrow 0^+} \log x = -\infty$. This function has no horizontal asymptotes.

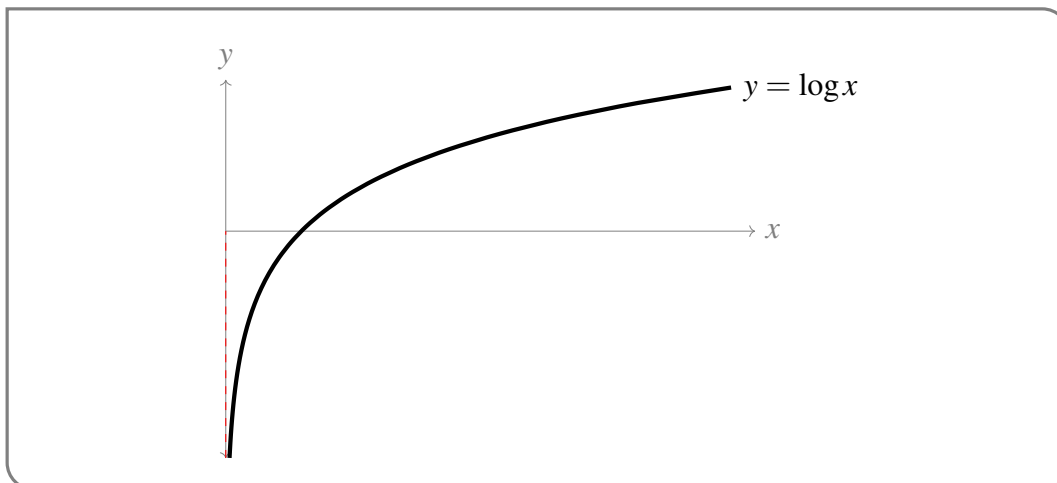

Example 2.2.8

Example 2.2.9 (Using limits to sketch)

Consider the function $f(x) = e^{1/x}$. Use the limits as x approaches 0, and as x goes to positive or negative infinity, to give a very rough sketch of $y = e^{1/x}$. Include all asymptotes.

To evaluate the one-sided limits as x approaches 0, we use our limit laws. In particular, we'll break down the function into two pieces: the exponential piece, and the $\frac{1}{x}$ piece. To make this very explicit, we'll set $t = \frac{1}{x}$.

$$\begin{aligned}\lim_{x \rightarrow 0^+} t &= \lim_{x \rightarrow 0^+} \frac{1}{x} = \infty \\ \implies \lim_{x \rightarrow 0^+} e^{\frac{1}{x}} &= \lim_{t \rightarrow \infty} e^t = \infty\end{aligned}$$

This tells us $e^{\frac{1}{x}}$ has a vertical asymptote at $x = 0$. Now let's find the limit from the other side.

$$\begin{aligned}\lim_{x \rightarrow 0^-} t &= \lim_{x \rightarrow 0^-} \frac{1}{x} = -\infty \\ \implies \lim_{x \rightarrow 0^-} e^{\frac{1}{x}} &= \lim_{t \rightarrow -\infty} e^t = 0\end{aligned}$$

So, interestingly, the limit from the right is infinite, while the limit from the left is finite. Finally, let's consider large-magnitude values of x :

$$\begin{aligned}\lim_{x \rightarrow \pm\infty} t &= \lim_{x \rightarrow \pm\infty} \frac{1}{x} = 0 \\ \implies \lim_{x \rightarrow \pm\infty} e^{1/x} &= e^0 = 1\end{aligned}$$

So there is a horizontal asymptote of $y = 1$ on both the left and the right.

Let's combine these observations with some pre-calculus knowledge.

- When x is large and positive, $e^{1/x} \approx 1$. Since $x > 0$, then $\frac{1}{x} > 0$, so $e^{1/x} > 1$. So, on the far right of our graph, our function will be close to 1, but a little larger.
- When x is large and negative, $e^{1/x} \approx 1$. Since $x < 0$, then $\frac{1}{x} < 0$, so $e^{1/x} < 1$. So, on the far left of our graph, our function will be close to 1, but a little smaller.
- When x approaches 0 from the left, $e^{1/x}$ approaches 0. So, from the left, our function will approach the origin. Note, however, that $e^{1/x}$ is not defined at $x = 0$.
- When x approaches 0 from the right, $e^{1/x}$ will blow up, increasing without bound.

These behaviours together can help us make a rough sketch of $y = f(x)$.

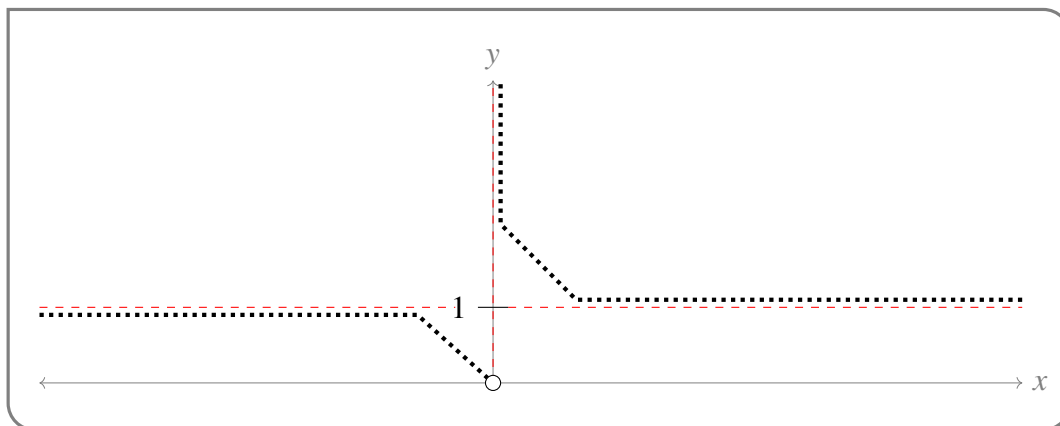

For interest, a more accurate graph of $y = f(x)$ is shown below. We repeat that you do not need to know how to achieve this level of accuracy right now, but you will learn it later.

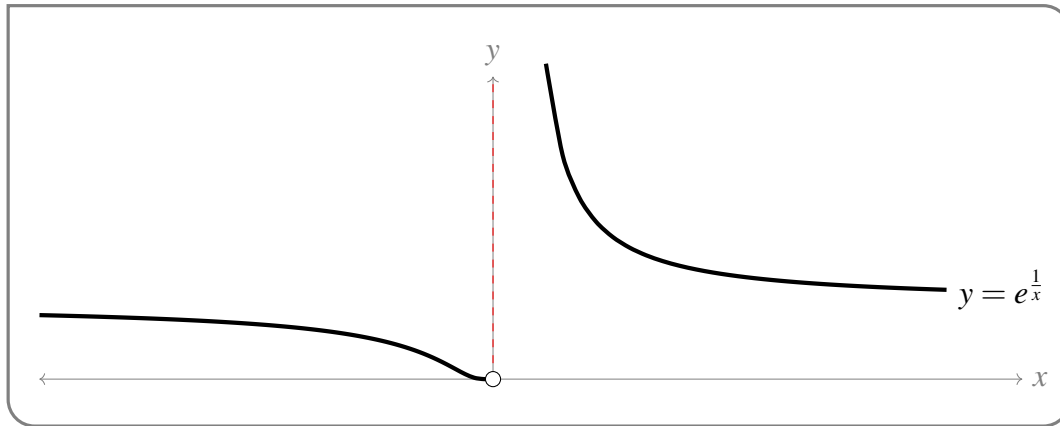

Example 2.2.9

2.3 ▲ Limits and continuity

Learning Objectives

- Explain informally and formally what it means for a function to be continuous on its domain.
- Identify and classify points of discontinuity (jump, infinite, removable).
- Determine where a given function is continuous. Use formal notation as well as informal explanation.
- Given a function defined with parameters, select parameter values that make the function continuous.

We have seen that computing the limits some functions — polynomials and rational functions — is very easy because

$$\lim_{x \rightarrow a} f(x) = f(a).$$

That is, the the limit as x approaches a is just $f(a)$. Roughly speaking, the reason we can compute the limit this way is that these functions do not have any abrupt jumps near a .

Many other functions have this property, $\sin(x)$ for example. A function with this property is called “continuous” and there is a precise mathematical definition for it.

Definition 2.3.1.

A function $f(x)$ is continuous at a if

$$\lim_{x \rightarrow a} f(x) = f(a).$$

If a function is not continuous at a then it is said to be discontinuous at a .

When we write that f is continuous without specifying a point, then typically this means that f is continuous at a for all $a \in \mathbb{R}$.

When we write that $f(x)$ is continuous on the open interval (a, b) then the function is continuous at every point c satisfying $a < c < b$.

So if a function is continuous at $x = a$ we immediately know that

- $f(a)$ exists
- $\lim_{x \rightarrow a^-} f(x)$ exists and is equal to $f(a)$, and
- $\lim_{x \rightarrow a^+} f(x)$ exists and is equal to $f(a)$.

We already know from our work above that polynomials are continuous, and that rational functions are continuous at all points in their domains — i.e. where their denominators are non-zero. As we did for limits, we will see that continuity interacts “nicely” with arithmetic. This will allow us to construct complicated continuous functions from simpler continuous building blocks (like polynomials).

But first, a few examples...

Example 2.3.2

Consider the functions drawn below

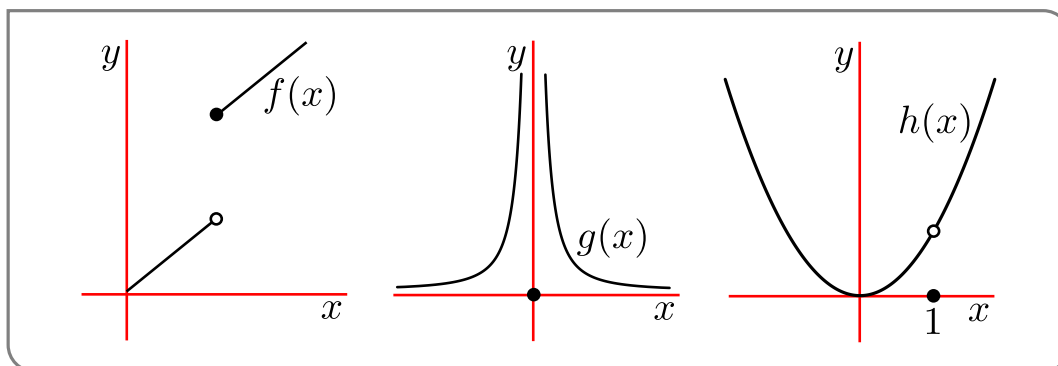

These are

$$f(x) = \begin{cases} x & x < 1 \\ x+2 & x \geq 1 \end{cases} \quad g(x) = \begin{cases} 1/x^2 & x \neq 0 \\ 0 & x = 0 \end{cases} \quad h(x) = \begin{cases} \frac{x^3-x^2}{x-1} & x \neq 1 \\ 0 & x = 1 \end{cases}$$

Determine where they are continuous and discontinuous:

- When $x < 1$ then $f(x)$ is a straight line (and so a polynomial) and so it is continuous at every point $x < 1$. Similarly when $x > 1$ the function is a straight line and so it is continuous at every point $x > 1$. The only point which might be a discontinuity is at $x = 1$. We see that the one sided limits are different. Hence the limit at $x = 1$ does not exist and so the function is discontinuous at $x = 1$.

But note that that $f(x)$ is continuous from one side — which?

- The middle case is much like the previous one. When $x \neq 0$ the $g(x)$ is a rational function and so is continuous everywhere on its domain (which is all reals except $x = 0$). Thus the only point where $g(x)$ might be discontinuous is at $x = 0$. We see that neither of the one-sided limits exist at $x = 0$, so the limit does not exist at $x = 0$. Hence the function is discontinuous at $x = 0$.
- We have seen the function $h(x)$ before. By the same reasoning as above, we know it is continuous except at $x = 1$ which we must check separately.

By definition of $h(x)$, $h(1) = 0$. We must compare this to the limit as $x \rightarrow 1$. We did this before.

$$\frac{x^3 - x^2}{x - 1} = \frac{x^2(x - 1)}{x - 1} = x^2$$

So $\lim_{x \rightarrow 1} \frac{x^3 - x^2}{x - 1} = \lim_{x \rightarrow 1} x^2 = 1 \neq h(1)$. Hence h is discontinuous at $x = 1$.

Example 2.3.2

This example illustrates different sorts of discontinuities:

- The function $f(x)$ has a “jump discontinuity” because the function “jumps” from one finite value on the left to another value on the right.
- The second function, $g(x)$, has an “infinite discontinuity” since $\lim f(x) = +\infty$.
- The third function, $h(x)$, has a “removable discontinuity” because we could make the function continuous at that point by redefining the function at that point. i.e. setting $h(1) = 1$. That is

$$\text{new function } h(x) = \begin{cases} \frac{x^3 - x^2}{x - 1} & x \neq 1 \\ 1 & x = 1 \end{cases}$$

Showing a function is continuous can be a pain, but just as the limit laws help us compute complicated limits in terms of simpler limits, we can use them to show that complicated functions are continuous by breaking them into simpler pieces.

Theorem 2.3.3 (Arithmetic of continuity).

Let $a, c \in \mathbb{R}$ and let $f(x)$ and $g(x)$ be functions that are continuous at a . Then the following functions are also continuous at $x = a$:

- $f(x) + g(x)$ and $f(x) - g(x)$,
- $cf(x)$ and $f(x)g(x)$, and
- $\frac{f(x)}{g(x)}$ provided $g(a) \neq 0$.

Above we stated that polynomials and rational functions are continuous (being careful about domains of rational functions — we must avoid the denominators being zero) without making it a formal statement. This is easily fixed...

Lemma 2.3.4.

Let $c \in \mathbb{R}$. The functions

$$f(x) = x$$

$$g(x) = c$$

are continuous everywhere on the real line

This isn't quite the result we wanted (that's a couple of lines below) but it is a small result that we can combine with the arithmetic of limits to get the result we want. Such small helpful results are called "lemmas" and they will arise more as we go along.

Now since we can obtain any polynomial and any rational function by carefully adding, subtracting, multiplying and dividing the functions $f(x) = x$ and $g(x) = c$, the above lemma combines with the "arithmetic of continuity" theorem to give us the result we want:

Theorem 2.3.5 (Continuity of polynomials and rational functions).

Every polynomial is continuous everywhere. Similarly every rational function is continuous except where its denominator is zero (i.e. on all its domain).

With some more work this result can be extended to wider families of functions:

Theorem 2.3.6.

The following functions are continuous at every point in the interior of their domains:

- polynomials, rational functions
- roots and powers
- trig functions and their inverses
- exponential and the logarithm

We haven't encountered inverse trigonometric functions, nor exponential functions or logarithms, but we will see them in the next chapter. For the moment, just file the information away.

Using a combination of the above results you can show that many complicated functions are continuous except at a few points (usually where a denominator is equal to zero).

Example 2.3.7

Where is the function $f(x) = \frac{\sin(x)}{2+\cos(x)}$ continuous?

We just break things down into pieces and then put them back together keeping track of where things might go wrong.

- The function is a ratio of two pieces — so check if the numerator is continuous, the denominator is continuous, and if the denominator might be zero.
- The numerator is $\sin(x)$ which is “continuous on its domain” according to one of the above theorems. Its domain is all real numbers¹², so it is continuous everywhere. No problems here.
- The denominator is the sum of 2 and $\cos(x)$. Since 2 is a constant it is continuous everywhere. Similarly (we just checked things for the previous point) we know that $\cos(x)$ is continuous everywhere. Hence the denominator is continuous.
- So we just need to check if the denominator is zero. One of the facts that we should know¹³ is that

$$-1 \leq \cos(x) \leq 1$$

and so by adding 2 we get

$$1 \leq 2 + \cos(x) \leq 3$$

Thus no matter what value of x , $2 + \cos(x) \geq 1$ and so cannot be zero.

- So the numerator is continuous, the denominator is continuous and nowhere zero, so the function is continuous everywhere.

12 Remember that \sin and \cos are defined on all real numbers, so $\tan(x) = \sin(x)/\cos(x)$ is continuous everywhere except where $\cos(x) = 0$. This happens when $x = \frac{\pi}{2} + n\pi$ for any integer n . If you cannot remember where $\tan(x)$ “blows up” or $\sin(x) = 0$ or $\cos(x) = 0$ then you should definitely revise trigonometric functions. Come to think of it — just revise them anyway.

13 If you do not know this fact then you should revise trigonometric functions. See the previous footnote.

If the function were changed to $\frac{\sin(x)}{x^2 - 5x + 6}$ much of the same reasoning can be used. Being a little terse we could answer with:

- Numerator and denominator are continuous.
- Since $x^2 - 5x + 6 = (x - 2)(x - 3)$ the denominator is zero when $x = 2, 3$.
- So the function is continuous everywhere except possibly at $x = 2, 3$. In order to verify that the function really is discontinuous at those points, it suffices to verify that the numerator is non-zero at $x = 2, 3$. Indeed we know that $\sin(x)$ is zero only when $x = n\pi$ (for any integer n). Hence $\sin(2), \sin(3) \neq 0$. Thus the numerator is non-zero, while the denominator is zero and hence $x = 2, 3$ really are points of discontinuity.

Note that this example raises a subtle point about checking continuity when numerator and denominator are *simultaneously* zero. There are quite a few possible outcomes in this case and we need more sophisticated tools to adequately analyse the behaviour of functions near such points. We will return to this question later in the text after we have developed Taylor expansions.

Example 2.3.7

So we know what happens when we add subtract multiply and divide, but what about when we compose functions? Well — limits and compositions work nicely when things are continuous.

Theorem 2.3.8 (Compositions and continuity).

If f is continuous at b and $\lim_{x \rightarrow a} g(x) = b$ then $\lim_{x \rightarrow a} f(g(x)) = f(b)$. I.e.

$$\lim_{x \rightarrow a} f(g(x)) = f\left(\lim_{x \rightarrow a} g(x)\right)$$

Hence if g is continuous at a and f is continuous at $g(a)$ then the composite function $(f \circ g)(x) = f(g(x))$ is continuous at a .

So when we compose two continuous functions we get a new continuous function.

We can put this to use

Example 2.3.9

Where are the following functions continuous?

$$f(x) = \sin(x^2 + \cos(x))$$

$$g(x) = \sqrt{\sin(x)}$$

Our first step should be to break the functions down into pieces and study them. When we put them back together we should be careful of dividing by zero, or falling outside the domain.

- The function $f(x)$ is the composition of $\sin(x)$ with $x^2 + \cos(x)$.
- These pieces, $\sin(x), x^2, \cos(x)$ are continuous everywhere.

- So the sum $x^2 + \cos(x)$ is continuous everywhere
- And hence the composition of $\sin(x)$ and $x^2 + \cos(x)$ is continuous everywhere.

The second function is a little trickier.

- The function $g(x)$ is the composition of \sqrt{x} with $\sin(x)$.
- \sqrt{x} is continuous on its domain $x \geq 0$.
- $\sin(x)$ is continuous everywhere, but it is negative in many places.
- In order for $g(x)$ to be defined and continuous we must restrict x so that $\sin(x) \geq 0$.
- Recall the graph of $\sin(x)$:

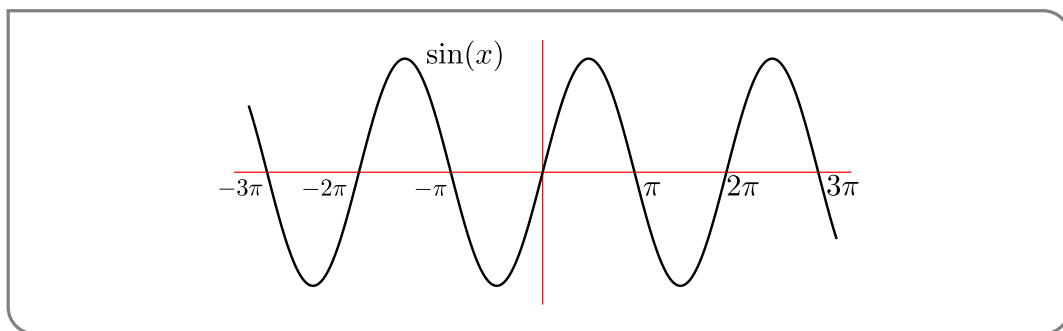

Hence $\sin(x) \geq 0$ when $x \in [0, \pi]$ or $x \in [2\pi, 3\pi]$ or $x \in [-2\pi, -\pi]$ or... To be more precise $\sin(x)$ is positive when $x \in [2n\pi, (2n+1)\pi]$ for any integer n .

- Hence $g(x)$ is continuous when $x \in [2n\pi, (2n+1)\pi]$ for any integer n .

Example 2.3.9

Continuous functions are very nice (mathematically speaking). Functions from the “real world” tend to be continuous (though not always). The key aspect that makes them nice is the fact that they don’t jump about.

Differentiation

INTRODUCTION TO THE DERIVATIVE

3.1 ▲ Review: lines

Learning Objectives

- Given an equation for a line, sketch the line, and identify its slope.
- Describe negative / positive / zero slope as corresponding to a line that is decreasing / increasing / constant over an interval.
- Find a line from two points; from a point and a slope; or from a clearly labelled graph.
- Find the slope at various points of a piecewise-linear function

As you'll soon see, derivatives and lines are closely related. To make the discussion of derivatives smoother¹, we'll do a quick review of lines.

3.1.1 ►► Equations and sketches

If you know the slope of a line, and one point on that line, then you can sketch it. Recall that the slope of a line, often remembered as “rise over run,” is the ratio of the changes of the vertical component (or dependent variable) to the horizontal component (or independent variable) between (any) two distinct points along the line.

For example, the line above has slope $-\frac{1}{2}$. For any two distinct points (x_0, y_0) and (x_1, y_1) on the line, the ratio $\frac{y_1 - y_0}{x_1 - x_0}$ is the same: $-\frac{1}{2}$.

$$\frac{0 - 2}{-1 - (-5)} = \frac{-1 - 0}{1 - (-1)} = \frac{-2.5 - (-1)}{4 - 1} = \frac{-2.5 - 2}{4 - (-5)} = -\frac{1}{2}$$

Generally speaking, you can think of the slope of a line as its steepness.

¹ This is a pun, but you might need to read a bit further to recognize it.

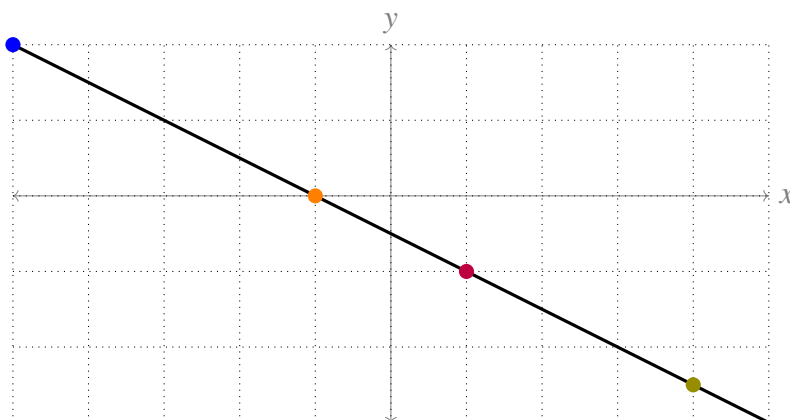

- A line of slope 0 is flat.
- A line whose slope has a large absolute value is steep.
- A line of positive slope is increasing (going upwards as you move to the right).
- A line of negative slope is decreasing (going downwards as you move to the right).

The equation of a line is in 'slope-intercept form' if it has the form

$$y = mx + b$$

where m and b are real numbers. The slope of the line is m , and it passes through the point $(0, b)$

Example 3.1.1

Sketch the line $y = 3x - 2$.

Solution: The slope of the line is 3, and the line passes through the point $(0, -2)$. So, we can start with putting a point at $(0, -2)$. Then, move right 1 and up 3 to find another point on the line, $(1, 1)$. Draw the line between these two points.

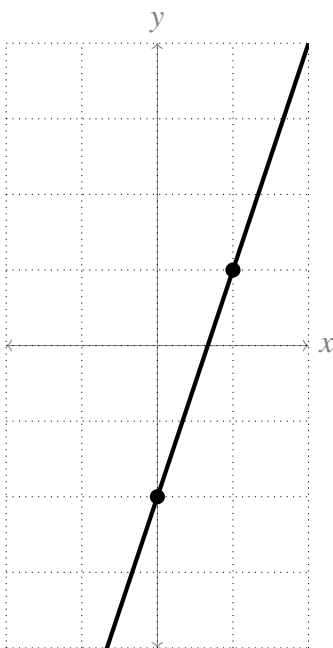

Example 3.1.1

Example 3.1.2

Sketch the line $y = 2(1 - x)$.**Solution:** This isn't in slope-intercept form, but we can manipulate it to be:

$$y = -2x + 2.$$

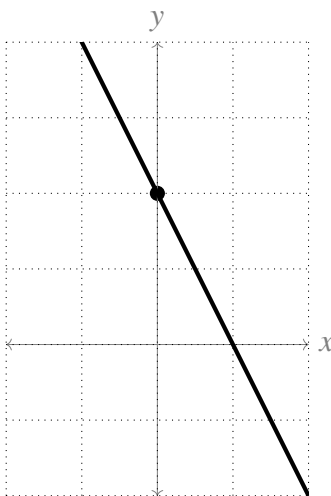
So, the slope of the line is -2 , and the line passes through the point $(0, 2)$.

Example 3.1.2

3.1.2 ▶▶ Different equation forms

Slope-intercept form is a common form to learn in high school, but it is not the only standard equation template for a line. Useful to us will be 'point-slope' form. A line passing through a point (x_0, y_0) , with slope m , can be described with the equation

$$y - y_0 = m(x - x_0).$$

Example 3.1.3

Give an equation for a line passing through the point $(1, 2)$ with slope 3.**Solution:** We aren't told which format to put it in. Since we have a point and a slope, point-slope format is easiest:

$$y - 2 = 3(x - 1).$$

Example 3.1.3

Example 3.1.4

Give an equation for a line passing through the points $(1, 2)$ and $(3, 3)$.

Solution: If we had the slope, we could use point-slope. So, let's find the slope!

$$m = \frac{\Delta y}{\Delta x} = \frac{3-2}{3-1} = \frac{1}{2}.$$

Now, we can write the line in point-slope form. The following two equations are equivalent to one another (and, therefore, both correct answers):

$$y - 2 = \frac{1}{2}(x - 1)$$

$$y - 3 = \frac{1}{2}(x - 3)$$

Since we weren't told which form to put the equation into, other answers are possible.

Example 3.1.4

Example 3.1.5

Find an equation for the line sketched below. Each gridline corresponds to a single unit.

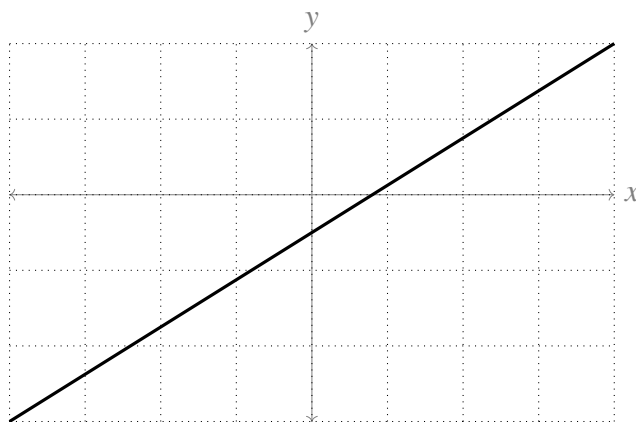

Solution: From the gridlines, we can be fairly certain that the line passes through the points $(-4, -3)$ and $(4, 2)$. (These are the only places shown where the line intersects a point on the grid where both the x - and y -values are integers. It's tough to guess at the exact value of a point on the line elsewhere, so we don't try.) As in Example 3.1.4, we use these two points to find the slope:

$$m = \frac{2 - (-3)}{4 - (-4)} = \frac{5}{8}$$

From here, the easiest format to use is point-slope. The two equations below are equivalent:

$$y + 3 = \frac{5}{8}(x + 4)$$

$$y - 2 = \frac{5}{8}(x - 4)$$

Example 3.1.5

Example 3.1.6

Each equation below describes a line. Sort them into collections of equations describing the *same* line.

A. $y = 2x + 1$

D. $y - 5 = 2(x - 2)$

G. $x = \frac{y-1}{2}$

B. $y = 2x - 1$

E. $2y + 2 = 4x$

H. $2 - y = x + 1$

C. $y = 1 - x$

F. $y - 1 = 2(x - 1)$

I. $y + 3 = 2(x + 1)$

Solution: One method is to manipulate each equation algebraically until they are in slope-intercept form, and then see which are the same. Equations A and B are already in slope-intercept form.

$C :$	$y = 1 - x$	
	$\iff y = -x + 1$	C is neither equivalent to A nor B
$D :$	$y - 5 = 2(x - 2)$	
	$\iff y - 5 = 2x - 4$	
	$\iff y = 2x + 1$	D is equivalent to A
$E :$	$2y + 2 = 4x$	
	$\iff 2y = 4x - 2$	
	$\iff y = 2x - 1$	E is equivalent to B
$F :$	$y - 1 = 2(x - 1)$	
	$\iff y - 1 = 2x - 2$	
	$\iff y = 2x - 1$	F is equivalent to B
$G :$	$x = \frac{y-1}{2}$	
	$\iff 2x = y - 1$	
	$\iff y = 2x + 1$	G is equivalent to A
$H :$	$2 - y = x + 1$	
	$\iff -2 + y = -x - 1$	
	$\iff y = -x + 1$	H is equivalent to C
$I :$	$y + 3 = 2(x + 1)$	
	$\iff y + 3 = 2x + 2$	
	$\iff y = 2x - 1$	I is equivalent to B

All together:

- A, D, and G are all equations for the same line;

- B, E, F, and I are all equations for the same line; and
- C and H are both equations for the same line.

Example 3.1.6

3.1.3 ▶▶ Slopes at different points

Suppose every piece of a piecewise-defined function is linear. Then at any point (except where the function switches from one piece to the other), the function *locally* looks like a line, so we can find its slope *at that point*.

Example 3.1.7

Consider the function below:

$$f(x) = \begin{cases} 3 - x & \text{for } x \leq -2 \\ 2x + 1 & \text{for } -2 < x \leq 1 \\ 5 - 2x & \text{for } x > 1 \end{cases}$$

Sketch $y = f(x)$, and give the slope of the line making up the function at all points x *except* $x = -2$ and $x = 1$. (In fact, we can call these numbers the slope of the function itself.)

Solution:

- For $x \leq -2$, we sketch a line with slope -1 . When x is (say) -3 , then y is 6 , so one point we know is $(-3, 6)$.
- For $-2 < x \leq 1$, the line to draw has slope 2 and passes through the point $(0, 1)$.
- For $x \geq 1$, we sketch a line with slope -2 . When x is (say) 2 , then y is 1 , so one point we know is $(2, 1)$.

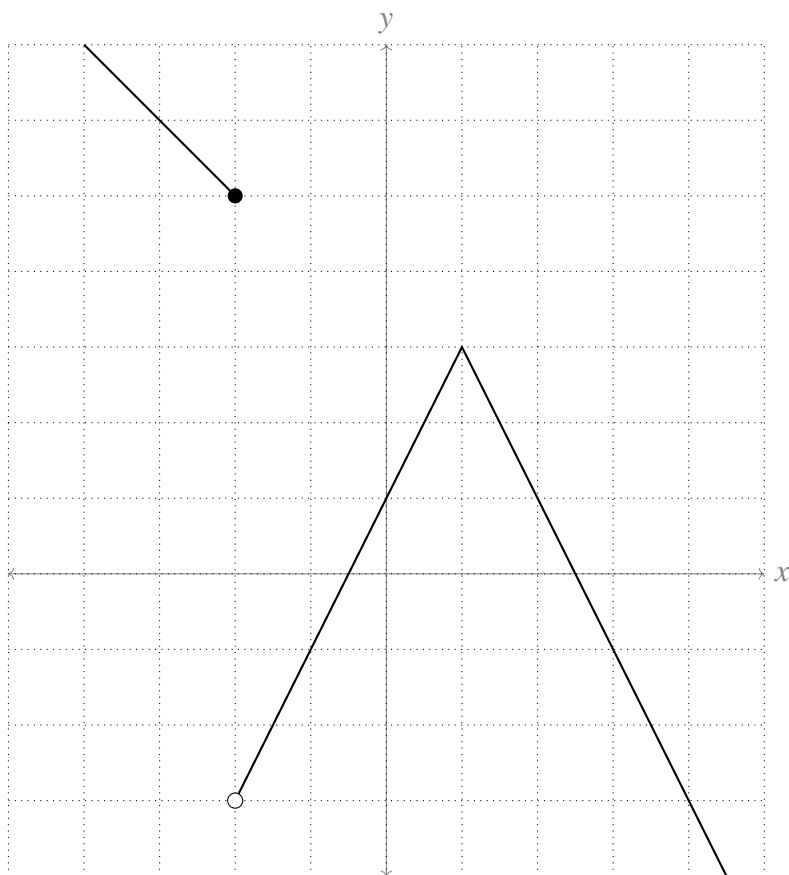

The slopes of the lines making up the function are:

$$\begin{cases} -1 & \text{for } -\infty < x < -2 \\ 2 & \text{for } -2 < x < 1 \\ -2 & \text{for } 1 < x < \infty \end{cases}$$

As you'll see later, it won't make sense to us to talk about the "slope" of the function when x is -2 or 1 . At these places, $f(x)$ doesn't look much like a line.

Example 3.1.7

3.2 ▲ Slopes and rates of change

Learning Objectives

- Describe the slope of a linear function as the rate of change of that function (change in y over change in x).
- Compute the average rate of change of a nonlinear function over an interval.

3.2.1 ▶▶ Lines and rate of change

So far we have talked a lot about equations for lines. Our goal now is to connect the slopes of lines (and then eventually curves) with the concepts of change and rate of change of functions. If a function $f(x)$ depends linearly on another variable x , this *linear relationship* can be described by the equation $f(x) = mx + b$.

Definition 3.2.1 (Rate of change for linear relationship).

For a linear relationship $f(x)$, we define the rate of change of $y = f(x)$ with respect to x as the ratio:

$$\frac{\text{change in } y}{\text{change in } x}.$$

A graph of $y = f(x)$ versus x is a straight line with slope m and intercept b . In section 3.1, we remembered the slope m of a line as the ratio of the changes of the vertical component (or dependent variable) to the horizontal component (or independent variable) between (any) two distinct points along the line. We can write this as $\frac{y_1 - y_0}{x_1 - x_0}$ or $\frac{f(x_1) - f(x_0)}{x_1 - x_0}$ or $\frac{\Delta y}{\Delta x}$. This is precisely the rate of change of y per unit rate of change² of x , and it is a constant. This is the property that distinguishes lines from other curves, and linear relationships from nonlinear ones:

Definition 3.2.2 (Slope of line is rate of change).

The slope m of a straight line with equation $y = mx + b$ is the rate of change of the linear function $y = f(x)$, and it is constant.

$$\frac{\text{change in } y}{\text{change in } x} = m.$$

The following example demonstrates how we can describe the slope of a line as the rate of change of a linear function (i.e., change in y per change in x , over any interval).

Example 3.2.3

In this example we look at the straight line

$$y = \frac{1}{2}x + \frac{3}{2}.$$

- From the slope of $\frac{1}{2}$, we claim that if, as we walk along this straight line, our x -coordinate changes by an amount Δx , then our y -coordinate changes by exactly $\Delta y = \frac{1}{2}\Delta x$. This is what we mean by *rate of change*.
- For example, in the figure on the left below, we move from the point

$$(x_0, y_0) = \left(1, 2 = \frac{1}{2} \times 1 + \frac{3}{2}\right)$$

² In the “real world” the phrase “rate of change” usually refers to rate of change per unit time. In science it is used more generally.

on the line to the point

$$(x_1, y_1) = \left(5, 4 = \frac{1}{2} \times 5 + \frac{3}{2}\right)$$

on the line. In this move our x -coordinate changes by

$$\Delta x = 5 - 1 = 4$$

and our y -coordinate changes by

$$\Delta y = 4 - 2 = 2$$

which is indeed $\frac{1}{2} \times 4 = \frac{1}{2} \Delta x$, as claimed.

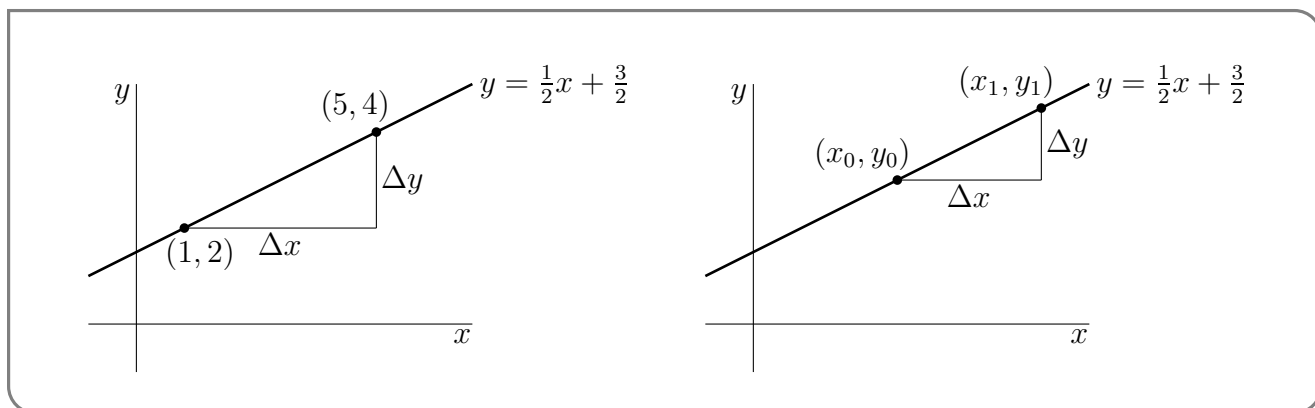

- In general, when we move from the point

$$(x_0, y_0) = \left(x_0, \frac{1}{2}x_0 + \frac{3}{2}\right)$$

on the line to the point

$$(x_1, y_1) = \left(x_1, \frac{1}{2}x_1 + \frac{3}{2}\right)$$

on the line, our x -coordinate changes by

$$\Delta x = x_1 - x_0$$

and our y -coordinate changes by

$$\begin{aligned} \Delta y &= y_1 - y_0 \\ &= \left[\frac{1}{2}x_1 + \frac{3}{2}\right] - \left[\frac{1}{2}x_0 + \frac{3}{2}\right] \\ &= \frac{1}{2}(x_1 - x_0) \end{aligned}$$

which is indeed $\frac{1}{2} \Delta x$, as claimed.

- So, for the straight line $y = \frac{1}{2}x + \frac{3}{2}$, the ratio $\frac{\Delta y}{\Delta x} = \frac{y_1 - y_0}{x_1 - x_0}$ always takes the value $\frac{1}{2}$, regardless of the choice of initial point (x_0, y_0) and final point (x_1, y_1) . This constant ratio is the rate of change and it is the slope of the line $y = \frac{1}{2}x + \frac{3}{2}$.

Example 3.2.3

3.2.2 ▶▶ Nonlinear functions and average rates of change

What if the function we are interested in is not linear, so that its graph is some kind of curve instead of a line? It might be exponential, or quadratic, or trigonometric, or maybe something we can't even name. How might we use what we know about slopes of lines to help us describe how a function $f(x)$ is changing as x changes? In this case, we can pick any two points $(x_0, f(x_0))$, and $(x_1, f(x_1))$ and *connect them with a line*. We call this a secant line:

Definition 3.2.4 (Secant line).

A straight line connecting any two points on the graph of a function is called a secant line of that function.

We define the average³ rate of change of a function $f(x)$ over an interval $x_0 \leq x \leq x_1$ as the slope of the straight line connecting the two points $(x_0, f(x_0))$, and $(x_1, f(x_1))$.

Definition 3.2.5 (Average rate of change over an interval is slope of secant).

The average rate of change of $y = f(x)$ over the interval $x_0 \leq x \leq x_1$ is the slope of the secant line through the two points $(x_0, f(x_0))$, and $(x_1, f(x_1))$:

$$\text{Average rate of change} = \frac{\text{change in } f}{\text{change in } x} = \frac{\Delta f}{\Delta x} = \frac{f(x_1) - f(x_0)}{x_1 - x_0}.$$

The average rate of change of a function can be interpreted in different ways, depending on what the function represents. When the function of interest represents distance with respect to time, its average rate of change is the average velocity:

Definition 3.2.6 (Average velocity).

For a moving body, the average velocity over a time interval $a \leq t \leq b$ is the average rate of change of distance over the given time interval.

$$\text{average velocity} = \frac{\Delta \text{distance}}{\Delta \text{time}}$$

Let's look at a nonlinear function and some of its secant lines.

Example 3.2.7

Consider the parabola $y = x^2$, which is the graph of the function $f(x) = x^2$.

3 The word "average" sometimes causes confusion. One often speaks in a different context about the average value of a set of numbers (e.g. the average of $\{7, 1, 3, 5\}$ is $(7 + 1 + 3 + 5)/4 = 4$.) However the term *average rate of change* always means the slope of the straight line joining a pair of points.

- Look at the interval between the points $(2, 4)$ and $(4, 16)$ on the parabola. If we draw a straight line connecting $(2, 4)$ and $(4, 16)$, this is a secant line for the parabola. This secant line has slope $m = \frac{\Delta y}{\Delta x} = \frac{16-4}{4-2} = \frac{12}{2} = 6$.

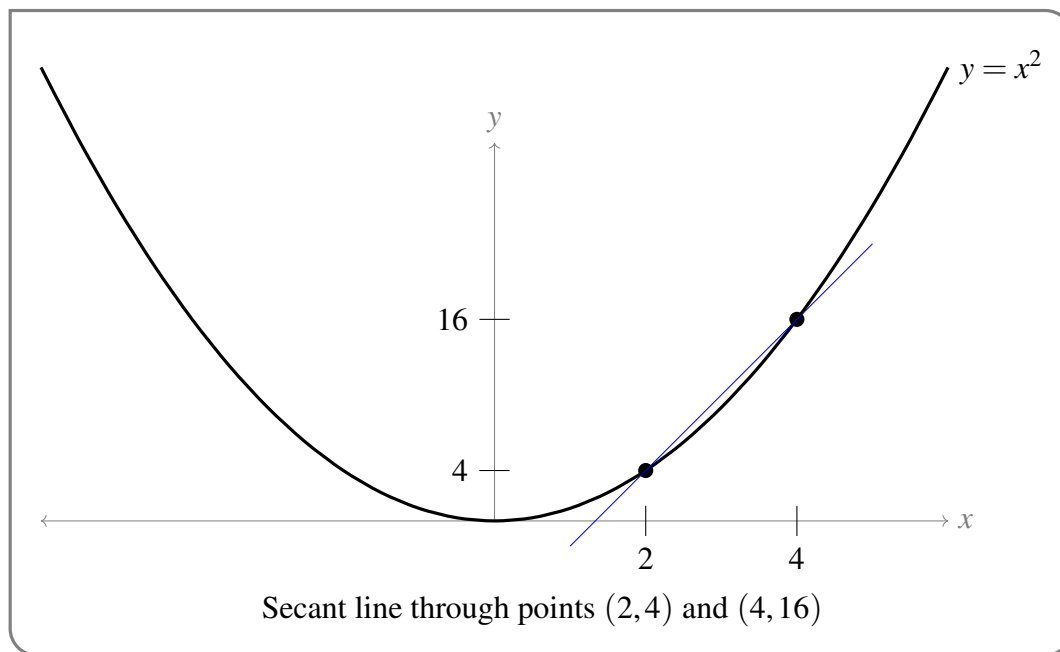

- The slope of the secant line connecting $(2, 4)$ and $(4, 16)$ is the average rate of change of the function over the interval $2 \leq x \leq 4$.
- Now consider the points $(2, 4)$ and $(5, 25)$ on the parabola. We can form a different secant line by connecting these two points with a straight line, which will have a slope of $m = \frac{\Delta y}{\Delta x} = \frac{25-4}{5-2} = \frac{21}{3} = 7$. This slope is the average rate of change of the function over the interval $2 \leq x \leq 5$.

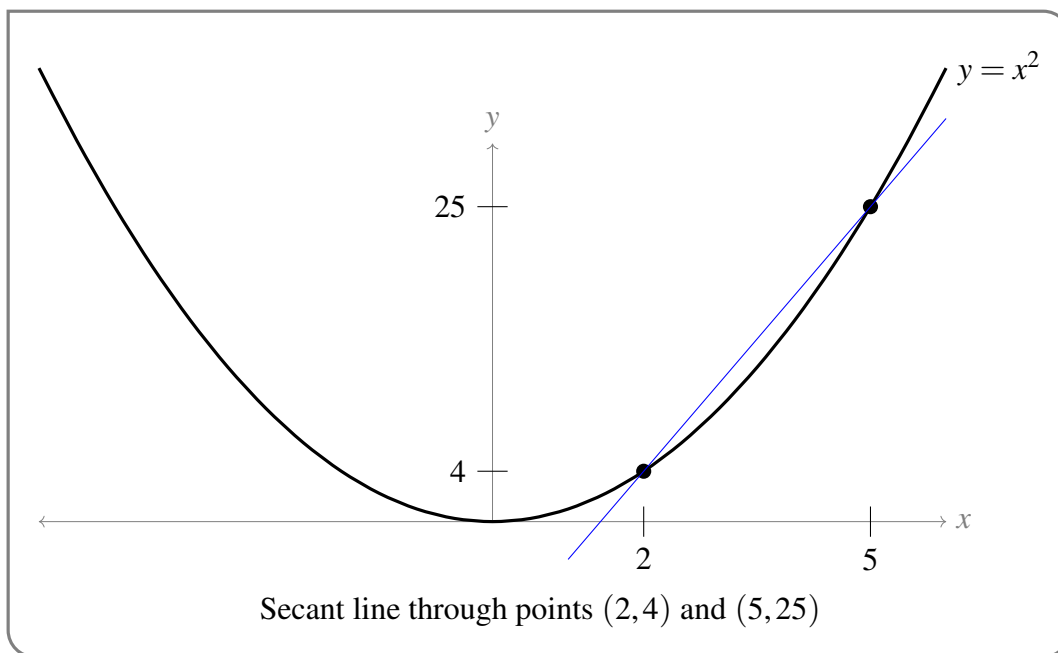

Example 3.2.7

Notice that different choices for either (or both) of the points (x_0, y_0) and (x_1, y_1) can result in different values for the slope $\frac{y_1 - y_0}{x_1 - x_0}$ of the secant through those points. Thus the average rate of change will, in general, depend on which two points we select. This is in contrast to the linear case; see the example below.

Example 3.2.8

Consider the line $y = \frac{1}{2}x + \frac{3}{2}$. If $y = f(x)$ is linear, then the secant through any two different points on a line is always identical to the line itself, and so always has exactly the same slope as the line itself. This is illustrated in Figure 3.2.1 below — the (yellow) secant through (x_0, y_0) and (x_1, y_1) lies exactly on top of the (red) line $y = \frac{1}{2}x + \frac{3}{2}$.

Figure 3.2.1.

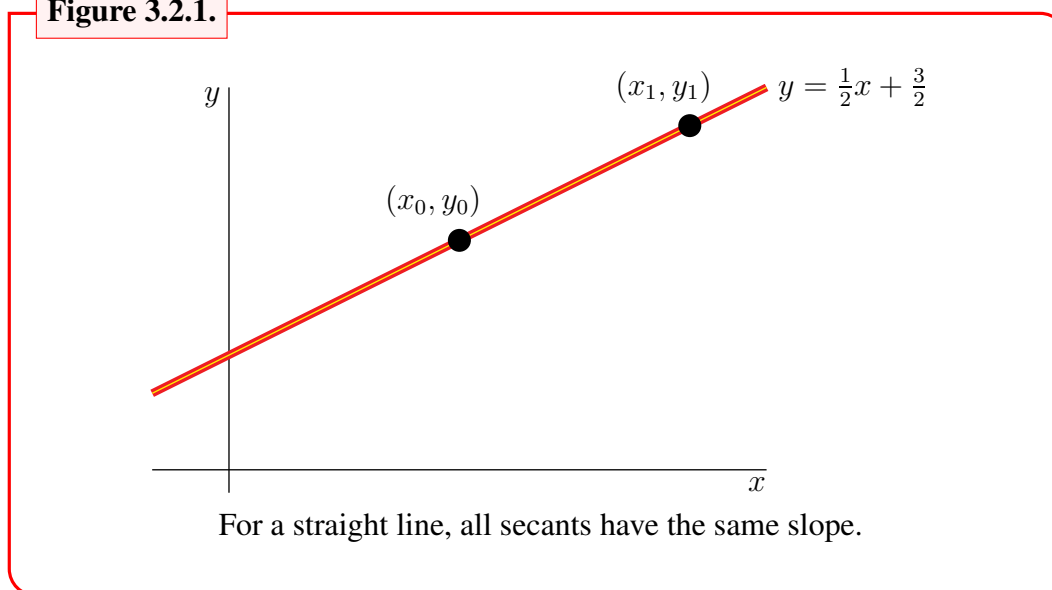

This also means that if $y = f(x)$ is linear, then the *average rate of change* (from 3.2.5) is the same as the *rate of change* (from 3.2.1); and both rates are equal to its slope.

Example 3.2.8

►► Alternative secant notation

Suppose $y = f(x)$ is some nonlinear function of x . Instead of picking two points and calling them $(x_0, f(x_0))$ and $(x_1, f(x_1))$ we could (and often do) alternatively pick one point $(x_0, f(x_0))$, and then pick a second x -value some distance h away from x_0 ,

$$x_1 = x_0 + h.$$

In other words, h is the difference of the two x coordinates. Then our two points are $(x_0, f(x_0))$ and $(x_0 + h, f(x_0 + h))$, and we can write the average rate of change of f across the interval

$x_0 \leq x \leq x_0 + h$ as

$$\frac{\Delta y}{\Delta x} = \frac{[f(x_0 + h) - f(x_0)]}{(x_0 + h) - x_0} = \frac{[f(x_0 + h) - f(x_0)]}{h}.$$

This ratio is the slope of the secant line through the two points.

Figure 3.2.2.

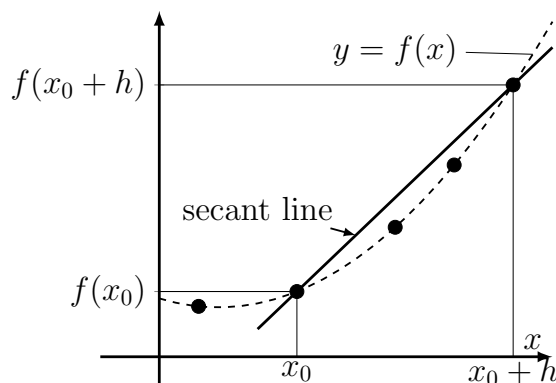

The slope of the secant line through the points $(x_0, f(x_0))$ and $(x_0 + h, f(x_0 + h))$ is the average rate of change of f over the given interval.

 A secant line between two points, x_0 and $x_0 + h$ on the graph of a function $f(x)$ is shown in this link. You can change the base point x_0 , the distance between the x coordinates, h , or you can input your own function for $f(x)$. The slope of the secant line is the average rate of change of f over the interval $x_0 \leq x \leq x_0 + h$

To summarize, now we have an alternative to the definition of average rate of change and the associated slope of the secant line provided in 3.2.5:

Definition 3.2.9 (Average rate of change over an interval is slope of secant (alternate)).

The average rate of change of $y = f(x)$ over the interval $x_0 \leq x \leq x_0 + h$ is the slope of the secant line through the two points $(x_0, f(x_0))$, and $(x_0 + h, f(x_0 + h))$:

$$\text{Average rate of change} = \frac{\text{change in } f}{\text{change in } x} = \frac{\Delta f}{\Delta x} = \frac{f(x_0 + h) - f(x_0)}{h}.$$

3.3 ▲ The derivative

Learning Objectives

- Explain using words, pictures, and the language of limits what a derivative is.
- Use the definition of derivative to find the tangent line to a function at a given point.

- Describe the tangent line as an approximation (the linear approximation) to a function at a given point.
- Describe the derivative of a function as a function itself.
- Given the graph of a function, sketch the graph of its derivative.
- Interpret derivatives as instantaneous rates of change
- Explain why the definition of a derivative is important, even if you know shortcuts for computation.

3.3.1 ▶▶ Slope at a point

In the previous section we introduced the idea of a secant line as a way to talk about the average rate of change of a function over a given interval. However, a function can change a lot between two given points. How does this affect the usefulness of the slope of a secant line connecting two points as a description of how a function is changing near those points? Well, if there is a lot of curviness in between the two points, then the average rate of change *between* those points might not describe what’s really happening at *either* point. What happens if we choose two points that are very close to each other?

We investigate, in Examples 3.3.1 and 3.3.2, below, the idea of a secant line to the parabola $y = x^2$ in the limit of the two points that are very close together – so close, in fact, that we get a line that touches the curve at a single point. This is called a *tangent*⁴ line.

In Example 3.3.1 we find the slope of the tangent line to $y = x^2$ at a particular point. We generalise this in Example 3.3.2, to show that we can define “the slope of the curve $y = x^2$ ” at an arbitrary point $x = x_0$ by considering $\frac{\Delta y}{\Delta x} = \frac{y_1 - y_0}{x_1 - x_0}$ with (x_1, y_1) very close to (x_0, y_0) .

Example 3.3.1

In this example, let us fix (x_0, y_0) to be the point $(2, 4)$ on the parabola $y = x^2$. Now let $(x_1, y_1) = (x_1, x_1^2)$ be some other point on the parabola; that is, a point with $x_1 \neq x_0$.

- Draw the straight line through (x_0, y_0) and (x_1, y_1) .
- The following table gives the slope, $\frac{y_1 - y_0}{x_1 - x_0}$, of the secant line through $(x_0, y_0) = (2, 4)$ and (x_1, y_1) , for various different choices of $(x_1, y_1 = x_1^2)$.

x_1	1	1.5	1.9	1.99	1.999	○	2.001	2.01	2.1	2.5	3
$y_1 = x_1^2$	1	2.25	3.61	3.9601	3.9960	○	4.0040	4.0401	4.41	6.25	9
$\frac{y_1 - y_0}{x_1 - x_0} = \frac{y_1 - 4}{x_1 - 2}$	3	3.5	3.9	3.99	3.999	○	4.001	4.01	4.1	4.5	5

- So now we have a big table of numbers — what do we do with them? Look at the columns of the table closer to the middle. As x_1 gets closer and closer to $x_0 = 2$, the slope, $\frac{y_1 - y_0}{x_1 - x_0}$, of the secant through (x_0, y_0) and (x_1, y_1) appears to get closer and closer to the value 4.

4 *tangens* means touching.

Example 3.3.1

Example 3.3.2

It is very easy to generalise what is happening in Example 3.3.1.

- Fix any point (x_0, y_0) on the parabola $y = x^2$. If (x_1, y_1) is any other point on the parabola $y = x^2$, then $y_1 = x_1^2$ and the slope of the secant through (x_0, y_0) and (x_1, y_1) is

$$\begin{aligned} \text{slope} &= \frac{y_1 - y_0}{x_1 - x_0} = \frac{x_1^2 - x_0^2}{x_1 - x_0} && \text{since } y = x^2 \\ &= \frac{(x_1 - x_0)(x_1 + x_0)}{x_1 - x_0} && \text{remember } a^2 - b^2 = (a - b)(a + b) \\ &= x_1 + x_0 \end{aligned}$$

You should check the values given in the table of Example 3.3.1 above to convince yourself that the slope $\frac{y_1 - y_0}{x_1 - x_0}$ of the secant line really is $x_0 + x_1 = 2 + x_1$ (since we set $x_0 = 2$).

- Now as we move x_1 closer and closer to x_0 , the slope should move closer and closer to $2x_0$. Indeed if we compute the limit carefully, we see that in the limit as $x_1 \rightarrow x_0$ the slope becomes $2x_0$. That is

$$\begin{aligned} \lim_{x_1 \rightarrow x_0} \frac{y_1 - y_0}{x_1 - x_0} &= \lim_{x_1 \rightarrow x_0} (x_1 + x_0) && \text{by the work we did just above} \\ &= 2x_0 \end{aligned}$$

(Note: Taking this limit gives us our first derivative. Of course we haven't yet given the definition of a derivative, so we perhaps wouldn't recognise it yet. We rectify this in the next section.)

Figure 3.3.1.

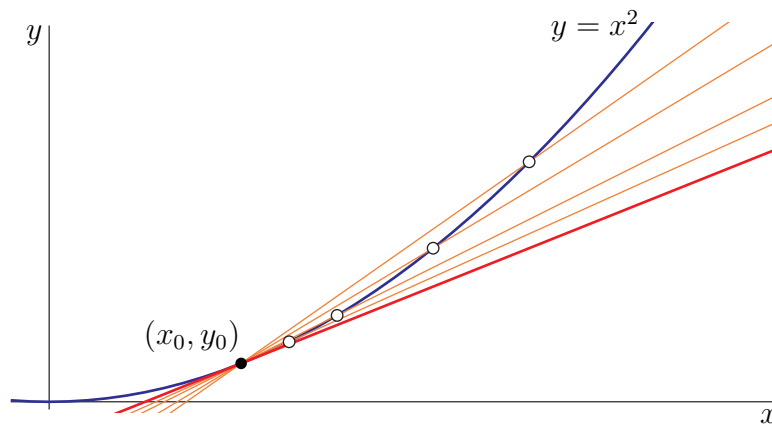

Secants approaching a tangent line

- So it is reasonable to say “as x_1 approaches x_0 , the secant through (x_0, y_0) and (x_1, y_1) approaches the tangent line to the parabola $y = x^2$ at (x_0, y_0) ”.

The figure above shows four different secants through (x_0, y_0) for the curve $y = x^2$. The four hollow circles are four different choices of (x_1, y_1) . As (x_1, y_1) approaches (x_0, y_0) , the corresponding secant does indeed approach the tangent to $y = x^2$ at (x_0, y_0) , which is the heavy (red) straight line in the figure.

Using limits we determined the slope of the tangent line to $y = x^2$ at x_0 to be $2x_0$. Often we will be a little sloppy with our language and instead say “the slope of the parabola $y = x^2$ at (x_0, y_0) is $2x_0$ ” — where we really mean the slope of the line tangent to the parabola at x_0 .

Example 3.3.2

3.3.2 ▶ Definition of the derivative (1)

We now define the “derivative” explicitly, based on the limiting slope ideas of the previous section. Then we see how to compute some simple derivatives.

Let us now generalise what we did in the last section so as to find “the slope of the curve $y = f(x)$ at (x_0, y_0) ” for any smooth enough⁵ function $f(x)$.

As before, let (x_0, y_0) be any point on the curve $y = f(x)$. So we must have $y_0 = f(x_0)$. Now let (x_1, y_1) be any other point on the same curve. So $y_1 = f(x_1)$ and $x_1 \neq x_0$. Think of (x_1, y_1) as being pretty close to (x_0, y_0) so that the difference

$$\Delta x = x_1 - x_0$$

in x -coordinates is pretty small. In terms of this Δx we have

$$x_1 = x_0 + \Delta x \quad \text{and} \quad y_1 = f(x_0 + \Delta x)$$

We can construct a secant line through (x_0, y_0) and (x_1, y_1) just as we did for the parabola above. It has slope

$$\frac{y_1 - y_0}{x_1 - x_0} = \frac{f(x_0 + \Delta x) - f(x_0)}{\Delta x}$$

If $f(x)$ is reasonably smooth⁶, then as x_1 approaches x_0 , i.e. as Δx approaches 0, we would expect the secant through (x_0, y_0) and (x_1, y_1) to approach the tangent line to the curve $y = f(x)$ at (x_0, y_0) , just as happened in Figure 3.3.1. And more importantly, the slope of the secant through (x_0, y_0) and (x_1, y_1) should approach the slope of the tangent line to the curve $y = f(x)$ at (x_0, y_0) .

Thus we would expect⁷ the slope of the tangent line to the curve $y = f(x)$ at (x_0, y_0) to be

$$\lim_{\Delta x \rightarrow 0} \frac{f(x_0 + \Delta x) - f(x_0)}{\Delta x}$$

5 The idea of “smooth enough” can be made quite precise. Indeed the word “smooth” has a very precise meaning in mathematics, which we won’t cover here. For now think of “smooth” as meaning roughly just “smooth”.

6 Again the term “reasonably smooth” can be made more precise.

7 Indeed, we don’t have to expect — it is!

When we talk of the “slope of the curve” at a point, what we really mean is the slope of the tangent line to the curve at that point. So “the slope of the curve $y = f(x)$ at (x_0, y_0) ” is also the limit⁸ expressed in the above equation. The derivative of $f(x)$ at $x = x_0$ is also defined to be this limit. Which leads⁹ us to the most important definition in this text:

Definition 3.3.3 (Derivative at a point).

Let $a \in \mathbb{R}$ and let $f(x)$ be defined on an open interval¹⁰ that contains a .

- The derivative of $f(x)$ at $x = a$ is denoted $f'(a)$ and is defined by

$$f'(a) = \lim_{h \rightarrow 0} \frac{f(a+h) - f(a)}{h}$$

if the limit exists.

- When the above limit exists, the function $f(x)$ is said to be differentiable at $x = a$. When the limit does not exist, the function $f(x)$ is said to be not differentiable at $x = a$.

- We can equivalently define the derivative $f'(a)$ by the limit

$$f'(a) = \lim_{x \rightarrow a} \frac{f(x) - f(a)}{x - a}.$$

To see that these two definitions are the same, we set $x = a + h$ and then the limit as h goes to 0 is equivalent to the limit as x goes to a .

- Informally, $f'(a)$ is the “slope of $f(x)$ at a ”. Formally, $f'(a)$ is the slope of the tangent line to $f(x)$ at $x = a$.

Let’s now compute the derivatives of some very simple functions. This is our first step towards building up a toolbox for computing derivatives of complicated functions — this process will very much parallel what we did in the previous chapter with limits. The two simplest functions we know are $f(x) = c$ and $g(x) = x$.

Example 3.3.4 (Derivative of $f(x) = c$)

Let $a, c \in \mathbb{R}$ be constants. Compute the derivative of the constant function $f(x) = c$ at $x = a$.

We compute the desired derivative by just substituting the function of interest into the formal

8 This is of course under the assumption that the limit exists — we will talk more about that below.

9 We will rename “ x_0 ” to “ a ” and “ Δx ” to “ h ”.

10 Maybe you remember this, but just in case you don’t: the open interval (c, d) is just the set of all real numbers obeying $c < x < d$.

definition of the derivative.

$$\begin{aligned}
 f'(a) &= \lim_{h \rightarrow 0} \frac{f(a+h) - f(a)}{h} && \text{(the definition)} \\
 &= \lim_{h \rightarrow 0} \frac{c - c}{h} && \text{(substituted in the function)} \\
 &= \lim_{h \rightarrow 0} 0 && \text{(simplified things)} \\
 &= 0
 \end{aligned}$$

Example 3.3.4

That was easy! What about the next most complicated function — arguably it's this one:

Example 3.3.5 (Derivative of $g(x) = x$)

Let $a \in \mathbb{R}$ and compute the derivative of $g(x) = x$ at $x = a$.

Again, we compute the derivative of g by just substituting the function of interest into the formal definition of the derivative and then evaluating the resulting limit.

$$\begin{aligned}
 g'(a) &= \lim_{h \rightarrow 0} \frac{g(a+h) - g(a)}{h} && \text{(the definition)} \\
 &= \lim_{h \rightarrow 0} \frac{(a+h) - a}{h} && \text{(substituted in the function)} \\
 &= \lim_{h \rightarrow 0} \frac{h}{h} && \text{(simplified things)} \\
 &= \lim_{h \rightarrow 0} 1 && \text{(simplified a bit more)} \\
 &= 1
 \end{aligned}$$

Example 3.3.5

That was a little harder than the first example, but still quite straight forward — start with the definition and apply what we know about limits.

Thanks to these two examples, we have our first theorem about derivatives:

Theorem 3.3.6 (Easiest derivatives).

Let $a, c \in \mathbb{R}$ and let $f(x) = c$ be the constant function and $g(x) = x$. Then

$$f'(a) = 0$$

and

$$g'(a) = 1.$$

3.3.3 ▶▶ Tangent lines and linear approximations

Suppose that $y = f(x)$ is the equation of a curve in the xy -plane. That is, $f(x)$ is the y -coordinate of the point on the curve whose x -coordinate is x . Then, as we have already seen,

$$[\text{the slope of the secant through } (a, f(a)) \text{ and } (a+h, f(a+h))] = \frac{f(a+h) - f(a)}{h}$$

This is shown in Figure 3.3.2 below.

Figure 3.3.2.

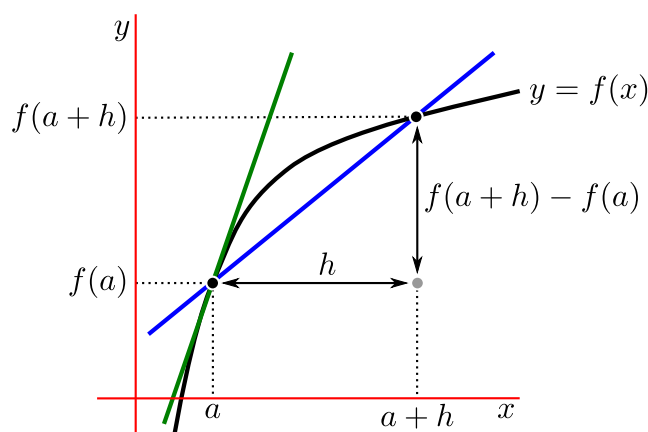

In order to create the tangent line (as we have done a few times now) we squeeze $h \rightarrow 0$. As we do this, the secant through $(a, f(a))$ and $(a+h, f(a+h))$ approaches¹¹ the tangent line to $y = f(x)$ at $x = a$. Since the secant becomes the tangent line in this limit, the slope of the secant becomes the slope of the tangent and

$$[\text{the slope of the tangent line to } y = f(x) \text{ at } x = a] = \lim_{h \rightarrow 0} \frac{f(a+h) - f(a)}{h} = f'(a).$$

 As $h \rightarrow 0$, the secant line approaches a **tangent line**. Use the slider for h to show this trend, and note that the slope of the secant line approaches the slope of the tangent line at the point x_0 .

Let us go a little further and work out a general formula for the equation of the tangent line to $y = f(x)$ at $x = a$. We know that the tangent line

- has slope $f'(a)$ and
- passes through the point $(a, f(a))$.

¹¹ We are of course assuming that the curve is smooth enough to have a tangent line at a .

There are a couple of different ways to construct the equation of the tangent line from this information. One is to observe, as in Figure 3.3.3, that if (x, y) is any other point on the tangent line then the line segment from $(a, f(a))$ to (x, y) is part of the tangent line and so also has slope $f'(a)$. That is,

$$\frac{y - f(a)}{x - a} = [\text{the slope of the tangent line}] = f'(a)$$

Cross multiplying gives us the equation of the tangent line:

$$y - f(a) = f'(a)(x - a) \quad \text{or} \quad y = f(a) + f'(a)(x - a)$$

Figure 3.3.3.

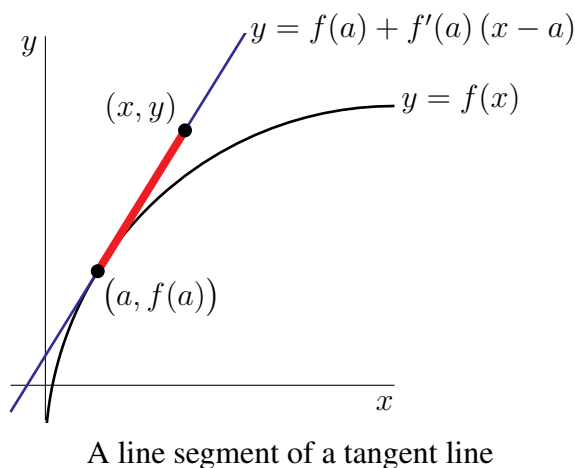

A second way to derive the same equation of the same tangent line is to recall that the general equation for a line, with finite slope, is $y = mx + b$, where m is the slope and b is the y -intercept. We already know the slope — so $m = f'(a)$. To work out b we use the other piece of information — $(a, f(a))$ is on the line. So $(x, y) = (a, f(a))$ must solve $y = f'(a)x + b$. That is,

$$f(a) = f'(a) \cdot a + b \quad \text{and so} \quad b = f(a) - af'(a)$$

Hence our equation is, once again,

$$\begin{aligned} y &= f'(a) \cdot x + (f(a) - af'(a)) && \text{or, after rearranging a little,} \\ y &= f(a) + f'(a)(x - a) \end{aligned}$$

This is a very useful formula, so perhaps we should make it a theorem.

Theorem 3.3.7 (Tangent line).

The tangent line to the curve $y = f(x)$ at $x = a$ is given by the equation

$$y = f(a) + f'(a)(x - a)$$

provided the derivative $f'(a)$ exists.

The caveat at the end of the above theorem is necessary — there are certainly cases in which the derivative does not exist and so we do need to be careful.

Example 3.3.8

Find the tangent line to the curve $y = x^2$ at $x = 3$.

Rather than redoing everything from scratch, we can, and for efficiency, should, use Theorem 3.3.7. To write this up properly, we must ensure that we tell the reader what we are doing. So something like the following:

- By Theorem 3.3.7, the tangent line to the curve $y = f(x)$ at $x = a$ is given by

$$y = f(a) + f'(a)(x - a)$$

provided $f'(a)$ exists.

- In Example 3.3.2, we found that, for any $x_0 > 0$, the derivative of x^2 at $x = x_0$ is

$$f'(x_0) = 2x_0.$$

The tangent line formula uses a instead of x_0 , so let's use a for the derivative at the point:

$$f'(a) = 2a.$$

- In the current example we are taking $a = 3$ and we have

$$f(a) = f(3) = a^2|_{a=3} = 3^2 = 9 \quad \text{and} \quad f'(a) = f'(3) = 2a|_{a=3} = 2 \cdot 3 = 6.$$

- So the equation of the tangent line to $y = x^2$ at $x = 3$ is

$$y = 9 + 6(x - 3) \quad \text{or} \quad y = 6x - 9.$$

We don't have to write it up using dot-points as above; we have used them here to help delineate each step in the process of computing the tangent line.

Example 3.3.8

In the example above, imagine “zooming in” to the point $(3, 9)$ and watching the curve of the function and the tangent line. As you zoom in closer and closer, the tangent line more and more closely matches the curve at that point. In fact, if we want to use a line to approximate a curve at any point $x = a$, the best we can do is indeed its tangent line at that point. (If you're not convinced: can you come up with a *different* line that passes through the point $(3, 9)$ that is a *better* approximation to x^2 than its tangent line there?)

Definition 3.3.9 (Linear approximation).

The *linear approximation* to $f(x)$ at $x = a$ is

$$L(x) = f(a) + f'(a)(x - a).$$

This is simply the tangent line to $f(x)$ at $x = a$.

The linear approximation to $f(x)$ at a is a better approximation to $f(x)$ near $x = a$ than other lines through $(a, f(a))$. You might start wondering: What kind of polynomial approximation might be a better approximation than the linear approximation? Why? We return to this idea in a later chapter when we discuss numerical approximations.

3.3.4 ▶ Definition of the derivative (2)

Let's redo the example we have already done a few times: $f(x) = x^2$. To make it a little more interesting (and gain some perspective on what the symbols represent) let's change the names of the function and the variable so that it is not exactly the same as Examples 3.3.1 and 3.3.2.

Example 3.3.10 (Derivative of $h(t) = t^2$)

Compute the derivative of

$$h(t) = t^2 \qquad \text{at } t = a$$

- This function isn't quite like the ones we saw earlier — it's a function of t rather than x . Recall that a function is a rule which assigns to each input value an output value. So far, we have usually called the input value x . But this “ x ” is just a dummy variable representing a generic input value. There is nothing wrong with calling a generic input value t instead. Indeed, from time to time you will see functions that are not written as formulas involving x , but instead are written as formulas in t (for example representing time), or z (for example representing height), or other symbols.
- So let us write the definition of the derivative

$$f'(a) = \lim_{h \rightarrow 0} \frac{f(a+h) - f(a)}{h}$$

and then translate it to the function names and variables at hand:

$$h'(a) = \lim_{h \rightarrow 0} \frac{h(a+h) - h(a)}{h}$$

- But there is a problem — “ h ” plays two roles here — it is both the function name and the small quantity that is going to zero in our limit. It is extremely dangerous to have a symbol represent two different things in a single computation. We need to change one of them. So let's rename the small quantity that is going to zero in our limit from “ h ” to “ Δt ”:

$$h'(a) = \lim_{\Delta t \rightarrow 0} \frac{h(a + \Delta t) - h(a)}{\Delta t}$$

- Now we are ready to begin. Substituting in what the function h is,

$$\begin{aligned} h'(a) &= \lim_{\Delta t \rightarrow 0} \frac{(a + \Delta t)^2 - a^2}{\Delta t} \\ &= \lim_{\Delta t \rightarrow 0} \frac{a^2 + 2a\Delta t + \Delta t^2 - a^2}{\Delta t} && \text{(just squared out } (a + \Delta t)^2) \\ &= \lim_{\Delta t \rightarrow 0} \frac{2a\Delta t + \Delta t^2}{\Delta t} \\ &= \lim_{\Delta t \rightarrow 0} (2a + \Delta t) \\ &= 2a \end{aligned}$$

- You should go back check that this is what we got in Example 3.3.2 — just some names have been changed.

Example 3.3.10

►► An important point (and some notation)

Notice here that the answer we get depends on our choice of a — if we want to know the derivative at $a = 3$ we can just substitute $a = 3$ into our answer $2a$ to get the slope is 6. If we want to know at $a = 1$, we substitute $a = 1$ and get that the slope is 2. The important thing here is that we can move from the derivative being computed at a specific point to the derivative being a function itself — input any value of a and it returns the slope of the tangent line to the curve at the point $x = a$, $y = h(a)$. The variable a is a dummy variable. We can rename a to anything we want, like x , for example. So we can replace every a in

$$h'(a) = 2a \quad \text{by } x, \text{ giving} \quad h'(x) = 2x$$

where all we have done is replaced the symbol a by the symbol x .

We can do this more generally and tweak the derivative at a specific point a to obtain the derivative as a function of x . We replace

$$f'(a) = \lim_{h \rightarrow 0} \frac{f(a+h) - f(a)}{h}$$

with

$$f'(x) = \lim_{h \rightarrow 0} \frac{f(x+h) - f(x)}{h}$$

which gives us the following definition

Definition 3.3.11 (Derivative as a function).

Let $f(x)$ be a function.

- The derivative of $f(x)$ with respect to x is

$$f'(x) = \lim_{h \rightarrow 0} \frac{f(x+h) - f(x)}{h}$$

provided the limit exists.

- If the derivative $f'(x)$ exists for all $x \in (a, b)$ we say that f is differentiable on (a, b) .
- Note that we will sometimes be a little sloppy with our discussions and simply write “ f is differentiable” to mean “ f is differentiable on an interval we are interested in” or “ f is differentiable everywhere”.
- Informally, the derivative is the “slope of $f(x)$ ”.

Notice that we are no longer thinking of tangent lines. Instead, differentiation is an operation we can do on a function – and moreover, the result (the derivative) is itself a function as well.

For example:

Example 3.3.12 (The derivative of $f(x) = \frac{1}{x}$)

Let $f(x) = \frac{1}{x}$ and compute its derivative with respect to x — think carefully about where the derivative exists.

- Our first step is to write down the definition of the derivative — at this stage, we know of no other strategy for computing derivatives.

$$f'(x) = \lim_{h \rightarrow 0} \frac{f(x+h) - f(x)}{h} \quad (\text{the definition})$$

- And now we substitute in the function and compute the limit.

$$\begin{aligned} f'(x) &= \lim_{h \rightarrow 0} \frac{f(x+h) - f(x)}{h} && (\text{the definition}) \\ &= \lim_{h \rightarrow 0} \frac{1}{h} \left[\frac{1}{x+h} - \frac{1}{x} \right] && (\text{substituted in the function}) \\ &= \lim_{h \rightarrow 0} \frac{1}{h} \frac{x - (x+h)}{x(x+h)} && (\text{wrote over a common denominator}) \\ &= \lim_{h \rightarrow 0} \frac{1}{h} \frac{-h}{x(x+h)} && (\text{started cleanup}) \\ &= \lim_{h \rightarrow 0} \frac{-1}{x(x+h)} \\ &= -\frac{1}{x^2} \end{aligned}$$

- Notice that the original function $f(x) = \frac{1}{x}$ was not defined at $x = 0$ and the derivative is also not defined at $x = 0$. This does happen more generally — if $f(x)$ is not defined at a particular point $x = a$, then the derivative will not exist at that point either.

Example 3.3.12

So we now have two slightly different ideas of derivatives:

- The derivative $f'(a)$ at a specific point $x = a$, being the slope of the tangent line to the curve at $x = a$, as defined in Definition 3.3.3, and
- The derivative as a function, $f'(x)$ as defined in Definition 3.3.11.

Of course, if we have $f'(x)$ then we can always recover the derivative at a specific point by substituting $x = a$.

As we noted at the beginning of the chapter, the derivative was discovered independently by Newton and Leibniz in the late 17th century. Because their discoveries were independent, Newton and Leibniz did not have exactly the same notation. Stemming from this, and from the many different contexts in which derivatives are used, there are quite a few alternate notations for the derivative:

Notation 3.3.13.

The following notations are all used for “the derivative of $f(x)$ with respect to x ”

$$f'(x) \quad \frac{df}{dx} \quad \frac{d}{dx}f(x) \quad \dot{f}(x) \quad Df(x) \quad D_x f(x),$$

while the following notations are all used for “the derivative of $f(x)$ at $x = a$ ”

$$f'(a) \quad \frac{df}{dx}(a) \quad \frac{d}{dx}f(x) \Big|_{x=a} \quad \dot{f}(a) \quad Df(a) \quad D_x f(a).$$

Some things to note about these notations:

- We will generally use the first three, but you should recognise them all. The notation $f'(a)$ is due to Lagrange, while the notation $\frac{df}{dx}(a)$ is due to Leibniz. They are both very useful. Neither can be considered “better”.
- Leibniz notation writes the derivative as a “fraction” — however it is definitely not a fraction and should not be thought of in that way. It is just shorthand, which is read as “the derivative of f with respect to x ”.
- You read $f'(x)$ as “ f -prime of x ”, and $\frac{df}{dx}$ as “dee- f -dee- x ”, and $\frac{d}{dx}f(x)$ as “dee-by-dee- x of f ”.
- Similarly you read $\frac{df}{dx}(a)$ as “dee- f -dee- x at a ”, and $\frac{d}{dx}f(x) \Big|_{x=a}$ as “dee-by-dee x of f at x equals a ”.
- The notation \dot{f} is due to Newton. In physics, it is common to use $\dot{f}(t)$ to denote the derivative of f with respect to time.

►► Back to computing some derivatives

At this point we could try to start working out how derivatives interact with arithmetic and make an “Arithmetic of derivatives” theorem just like the one we saw for limits in the previous chapter. We will get there shortly, but before that it is important that we become more comfortable with computing derivatives using limits and then understanding what the derivative actually means. So — more examples.

Example 3.3.14 ($\frac{d}{dx}\sqrt{x}$)

Compute the derivative, $f'(a)$, of the function $f(x) = \sqrt{x}$ at the point $x = a$ for any $a > 0$.

- So again we start with the definition of derivative and go from there:

$$f'(a) = \lim_{x \rightarrow a} \frac{f(x) - f(a)}{x - a} = \lim_{x \rightarrow a} \frac{\sqrt{x} - \sqrt{a}}{x - a}$$

- As x tends to a , the numerator and denominator both tend to zero. But $\frac{0}{0}$ is not defined.

So to get a well defined limit we need to exhibit a cancellation between the numerator and denominator — just as we saw in Example 2.1.24.

- Recall how to factor the difference of two perfect squares: set $A = \sqrt{x}$ and $B = \sqrt{a}$ in $A^2 - B^2 = (A - B)(A + B)$ to get

$$x - a = (\sqrt{x} - \sqrt{a})(\sqrt{x} + \sqrt{a})$$

and then substitute this little fact into our expression

$$\begin{aligned} \frac{\sqrt{x} - \sqrt{a}}{x - a} &= \frac{\sqrt{x} - \sqrt{a}}{(\sqrt{x} - \sqrt{a})(\sqrt{x} + \sqrt{a})} && \text{(now cancel common factors)} \\ &= \frac{1}{\sqrt{x} + \sqrt{a}} \end{aligned}$$

- Now we can take the limit we need:

$$\begin{aligned} f'(a) &= \lim_{x \rightarrow a} \frac{\sqrt{x} - \sqrt{a}}{x - a} \\ &= \lim_{x \rightarrow a} \frac{1}{\sqrt{x} + \sqrt{a}} \\ &= \frac{1}{2\sqrt{a}} \end{aligned}$$

- We should think about the domain of f' here — that is, for which values of a is $f'(a)$ defined? The original function $f(x)$ was defined for all $x \geq 0$, however the derivative $f'(a) = \frac{1}{2\sqrt{a}}$ is undefined at $a = 0$.

If we draw a careful picture of \sqrt{x} around $x = 0$ we can see why this has to be the case. The figure below shows three different tangent lines to the graph of $y = f(x) = \sqrt{x}$. As the point of tangency moves closer and closer to the origin, the tangent line gets steeper and steeper. The slope of the tangent line at (a, \sqrt{a}) blows up as $a \rightarrow 0$.

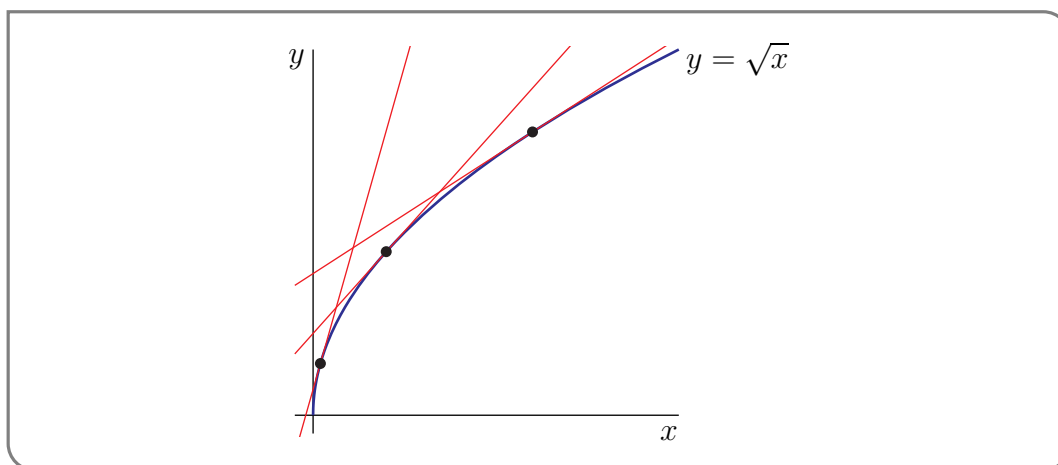

Example 3.3.14

Example 3.3.15 $\left(\frac{d}{dx} \{|x|\}\right)$

Compute the derivative, $f'(a)$, of the function $f(x) = |x|$ at the point $x = a$.

- We should start this example by recalling the definition of $|x|$ (we saw this back in Example 2.1.33):

$$|x| = \begin{cases} -x & \text{if } x < 0 \\ 0 & \text{if } x = 0 \\ x & \text{if } x > 0. \end{cases}$$

It is definitely not just “chop off the minus sign”.

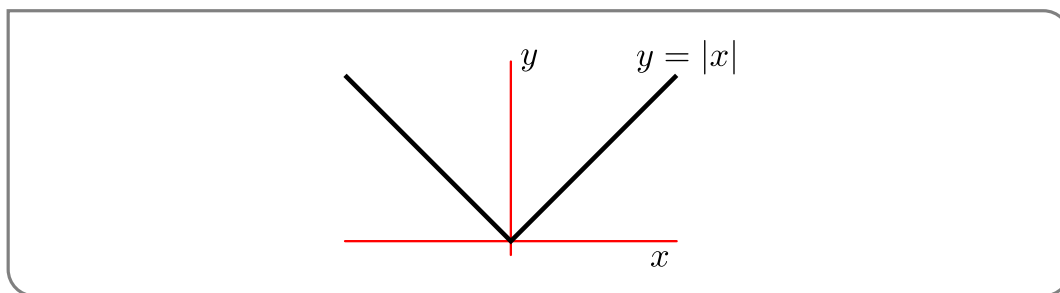

- This breaks our computation of the derivative into 3 cases depending on whether x is positive, negative or zero.
- Assume $x > 0$. Then

$$\begin{aligned} \frac{df}{dx} &= \lim_{h \rightarrow 0} \frac{f(x+h) - f(x)}{h} \\ &= \lim_{h \rightarrow 0} \frac{|x+h| - |x|}{h} \end{aligned}$$

Since $x > 0$ and we are interested in the behaviour of this function as $h \rightarrow 0$ we can assume h is much smaller than x . This means $x+h > 0$ and so $|x+h| = x+h$.

$$\begin{aligned} &= \lim_{h \rightarrow 0} \frac{x+h-x}{h} \\ &= \lim_{h \rightarrow 0} \frac{h}{h} = 1 \end{aligned} \quad \text{as expected}$$

- Assume $x < 0$. Then

$$\begin{aligned} \frac{df}{dx} &= \lim_{h \rightarrow 0} \frac{f(x+h) - f(x)}{h} \\ &= \lim_{h \rightarrow 0} \frac{|x+h| - |x|}{h} \end{aligned}$$

Since $x < 0$ and we are interested in the behaviour of this function as $h \rightarrow 0$ we can assume h is much smaller than x . This means $x+h < 0$ and so $|x+h| = -(x+h)$.

$$\begin{aligned} &= \lim_{h \rightarrow 0} \frac{-(x+h) - (-x)}{h} \\ &= \lim_{h \rightarrow 0} \frac{-h}{h} = -1 \end{aligned}$$

- When $x = 0$ we have

$$\begin{aligned} f'(0) &= \lim_{h \rightarrow 0} \frac{f(0+h) - f(0)}{h} \\ &= \lim_{h \rightarrow 0} \frac{|0+h| - |0|}{h} \\ &= \lim_{h \rightarrow 0} \frac{|h|}{h} \end{aligned}$$

To proceed we need to know if $h > 0$ or $h < 0$, so we must use one-sided limits. The limit from above is:

$$\begin{aligned} \lim_{h \rightarrow 0^+} \frac{|h|}{h} &= \lim_{h \rightarrow 0^+} \frac{h}{h} && \text{since } h > 0, |h| = h \\ &= 1 \end{aligned}$$

Whereas, the limit from below is:

$$\begin{aligned} \lim_{h \rightarrow 0^-} \frac{|h|}{h} &= \lim_{h \rightarrow 0^-} \frac{-h}{h} && \text{since } h < 0, |h| = -h \\ &= -1 \end{aligned}$$

Since the one-sided limits differ, the limit as $h \rightarrow 0$ does not exist. And thus the derivative does not exist as $x = 0$.

In summary:

$$\frac{d}{dx}|x| = \begin{cases} -1 & \text{if } x < 0 \\ DNE & \text{if } x = 0 \\ 1 & \text{if } x > 0 \end{cases}$$

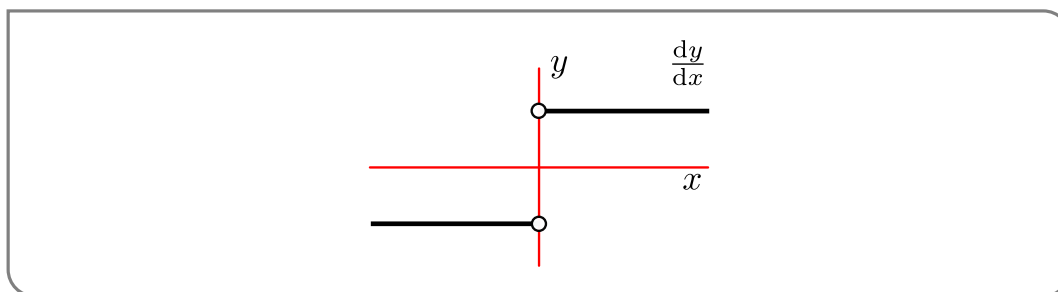

Example 3.3.15

►► Where is the derivative undefined?

According to Definition 3.3.3, the derivative $f'(a)$ exists precisely when the limit $\lim_{x \rightarrow a} \frac{f(x) - f(a)}{x - a}$ exists. That limit is also the slope of the tangent line to the curve $y = f(x)$ at $x = a$. That limit does not exist when the curve $y = f(x)$ does not have a tangent line at $x = a$ or when the curve does have a tangent line, but the tangent line has infinite slope. We have already seen some examples of this.

- In Example 3.3.12, we considered the function $f(x) = \frac{1}{x}$. This function “blows up” (i.e. becomes infinite) at $x = 0$. It does not have a tangent line at $x = 0$ and its derivative does not exist at $x = 0$.
- In Example 3.3.15, we considered the function $f(x) = |x|$. This function does not have a tangent line at $x = 0$, because there is a sharp corner in the graph of $y = |x|$ at $x = 0$. (Look at the graph in Example 2.2.10.) So the derivative of $f(x) = |x|$ does not exist at $x = 0$.

Here are a few more examples.

Example 3.3.16

Visually, the function

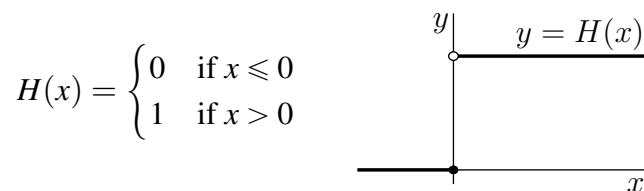

does not have a tangent line at $(0, 0)$. Not surprisingly, when $a = 0$ and h tends to 0 with $h > 0$,

$$\frac{H(a+h) - H(a)}{h} = \frac{H(h) - H(0)}{h} = \frac{1}{h}$$

blows up. The same sort of computation shows that $f'(a)$ cannot possibly exist whenever the function f is not continuous at a . We will formalize, and prove, this statement in Theorem 3.3.19, below.

Example 3.3.16

Example 3.3.17 ($\frac{d}{dx}x^{1/3}$)

Visually, it looks like the function $f(x) = x^{1/3}$, sketched below, (this might be a good point to recall that cube roots of negative numbers are negative — for example, since $(-1)^3 = -1$, the cube root of -1 is -1),

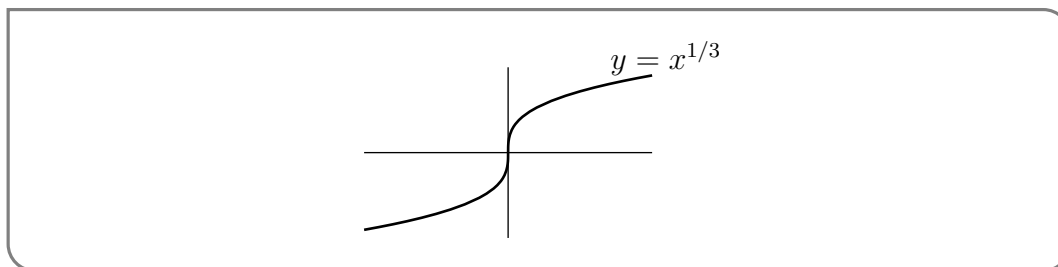

has the y -axis as its tangent line at $(0, 0)$. So we would expect that $f'(0)$ does not exist. Let's check. With $a = 0$,

$$f'(a) = \lim_{h \rightarrow 0} \frac{f(a+h) - f(a)}{h} = \lim_{h \rightarrow 0} \frac{f(h) - f(0)}{h} = \lim_{h \rightarrow 0} \frac{h^{1/3}}{h} = \lim_{h \rightarrow 0} \frac{1}{h^{2/3}} = DNE$$

as expected.

Example 3.3.17

Example 3.3.18 $\left(\frac{d}{dx} \sqrt{|x|}\right)$

We have already considered the derivative of the function \sqrt{x} in Example 3.3.14. We'll now look at the function $f(x) = \sqrt{|x|}$. Recall, from Example 3.3.15, the definition of $|x|$. When $x > 0$, we have $|x| = x$ and $f(x)$ is identical to \sqrt{x} . When $x < 0$, we have $|x| = -x$ and $f(x) = \sqrt{-x}$. So to graph $y = \sqrt{|x|}$ when $x < 0$, you just have to graph $y = \sqrt{x}$ for $x > 0$ and then send $x \rightarrow -x$ — i.e. reflect the graph in the y -axis. Here is the graph. The pointy thing at the origin is called a cusp. The graph

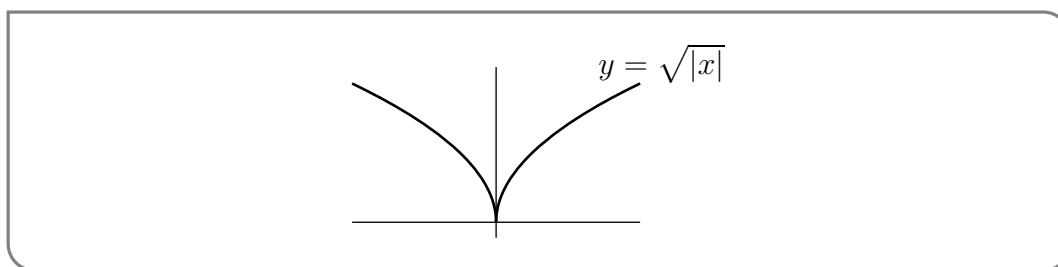

of $y = f(x)$ does not have a tangent line at $(0,0)$ and, correspondingly, $f'(0)$ does not exist because

$$\lim_{h \rightarrow 0^+} \frac{f(h) - f(0)}{h} = \lim_{h \rightarrow 0^+} \frac{\sqrt{|h|}}{h} = \lim_{h \rightarrow 0^+} \frac{1}{\sqrt{h}} = DNE$$

Example 3.3.18

Theorem 3.3.19.

If the function $f(x)$ is differentiable at $x = a$, then $f(x)$ is also continuous at $x = a$.

Proof. The function $f(x)$ is continuous at $x = a$ if and only if the limit of

$$f(a+h) - f(a) = \frac{f(a+h) - f(a)}{h} h$$

as $h \rightarrow 0$ exists and is zero. But if $f(x)$ is differentiable at $x = a$, then, as $h \rightarrow 0$, the first factor, $\frac{f(a+h) - f(a)}{h}$ converges to $f'(a)$ and the second factor, h , converges to zero. So the product provision of our arithmetic of limits Theorem 2.1.15 implies that the product $\frac{f(a+h) - f(a)}{h} h$ converges to $f'(a) \cdot 0 = 0$ too. \square

Notice that while this theorem is useful as stated, it is (arguably) more often applied in its contrapositive¹² form:

12 If you have forgotten what the contrapositive is, then quickly reread Footnote 3 in Section 2.1.

Theorem 3.3.20 (The contrapositive of Theorem 3.3.19).

If $f(x)$ is not continuous at $x = a$ then it is not differentiable at $x = a$.

As the above examples illustrate, this statement does not tell us what happens if f is continuous at $x = a$ — we have to think!

3.3.5 ▶ Instantaneous rate of change

In the previous sections we defined the derivative as the slope of a tangent line, using a particular limit. This allows us to compute “the slope of a curve¹³” and provides us with one interpretation of the derivative. However, the main importance of derivatives does not come from this application. Instead, (arguably) it comes from the interpretation of the derivative as the instantaneous rate of change of a quantity.

Just as the average rate of change can represent the average velocity, when we talk about the instantaneous rate of change we might specify it as the instantaneous velocity (if the function is distance with respect to time). That’s what we do in this example.

Example 3.3.21

You drop a ball from a tall building. After t seconds the ball has fallen a distance of $s(t) = 4.9t^2$ metres. What is the velocity of the ball one second after it is dropped?

- In the time interval from $t = 1$ to $t = 1 + h$ the ball travels a distance

$$s(1+h) - s(1) = 4.9(1+h)^2 - 4.9(1)^2 = 4.9[2h + h^2]$$

- So the average velocity over this time interval is

$$\begin{aligned} & \text{average velocity from } t = 1 \text{ to } t = 1 + h \\ &= \frac{\text{distance travelled from } t = 1 \text{ to } t = 1 + h}{\text{length of time from } t = 1 \text{ to } t = 1 + h} \\ &= \frac{s(1+h) - s(1)}{h} \\ &= \frac{4.9[2h + h^2]}{h} \\ &= 4.9[2 + h] \end{aligned}$$

¹³ Again — recall that we are being a little sloppy with this term — we really mean “The slope of the tangent line to the curve”.

- The instantaneous velocity at time $t = 1$ is then defined to be the limit

$$\begin{aligned}
 & \text{instantaneous velocity at time } t = 1 \\
 &= \lim_{h \rightarrow 0} [\text{average velocity from } t = 1 \text{ to } t = 1 + h] \\
 &= \lim_{h \rightarrow 0} \frac{s(1+h) - s(1)}{h} = s'(1) \\
 &= \lim_{h \rightarrow 0} 4.9[2+h] \\
 &= 9.8\text{m/sec}
 \end{aligned}$$

- We conclude that the instantaneous velocity at time $t = 1$, which is the instantaneous rate of change of distance per unit time at time $t = 1$, is the derivative $s'(1) = 9.8\text{m/sec}$.

Example 3.3.21

Now suppose, more generally, that you are taking a walk and that as you walk, you are continuously measuring some quantity, like temperature, and that the measurement at time t is $f(t)$. Then the

$$\begin{aligned}
 & \text{average rate of change of } f(t) \text{ from } t = a \text{ to } t = a + h \\
 &= \frac{\text{change in } f(t) \text{ from } t = a \text{ to } t = a + h}{\text{length of time from } t = a \text{ to } t = a + h} \\
 &= \frac{f(a+h) - f(a)}{h}
 \end{aligned}$$

so the

$$\begin{aligned}
 & \text{instantaneous rate of change of } f(t) \text{ at } t = a \\
 &= \lim_{h \rightarrow 0} [\text{average rate of change of } f(t) \text{ from } t = a \text{ to } t = a + h] \\
 &= \lim_{h \rightarrow 0} \frac{f(a+h) - f(a)}{h} \\
 &= f'(a)
 \end{aligned}$$

In particular, if you are walking along the x -axis and your x -coordinate at time t is $x(t)$, then $x'(a)$ is the instantaneous rate of change (per unit time) of your x -coordinate at time $t = a$, which is your velocity at time a . If $v(t)$ is your velocity at time t , then $v'(a)$ is the instantaneous rate of change of your velocity at time a . This is called your acceleration at time a .

You might expect that if the instantaneous rate of change of a function at time c is strictly positive, then, in some sense, the function is increasing at $t = c$. You would be right. Indeed, if $f'(c) > 0$, then, by definition, the limit of $\frac{f(t)-f(c)}{t-c}$ as t approaches c is strictly bigger than zero. So

- for all $t > c$ that are sufficiently close¹⁴ to c

$$\begin{aligned}\frac{f(t) - f(c)}{t - c} > 0 &\implies f(t) - f(c) > 0 && \text{(since } t - c > 0\text{)} \\ &\implies f(t) > f(c)\end{aligned}$$

- for all $t < c$ that are sufficiently close to c

$$\begin{aligned}\frac{f(t) - f(c)}{t - c} > 0 &\implies f(t) - f(c) < 0 && \text{(since } t - c < 0\text{)} \\ &\implies f(t) < f(c)\end{aligned}$$

Consequently we say that “ $f(t)$ is increasing at $t = c$ ”. If we wish to emphasise that the inequalities above are the strict inequalities $>$ and $<$, as opposed to \geq and \leq , we will say that “ $f(t)$ is strictly increasing at $t = c$ ”.

3.4 ▲ Higher order derivatives

Learning Objectives

- Understand what is meant by ‘higher-order derivatives,’ and compute them.

The operation of differentiation takes as input one function, $f(x)$, and produces as output another function, $f'(x)$. Now $f'(x)$ is once again a function. So we can differentiate it again, assuming that it is differentiable, to create a third function, called the second derivative of f . And we can differentiate the second derivative again to create a fourth function, called the third derivative of f . And so on.

Notation 3.4.1.

- $f''(x)$ and $f^{(2)}(x)$ and $\frac{d^2 f}{dx^2}(x)$ all mean $\frac{d}{dx}\left(\frac{d}{dx}f(x)\right)$
- $f'''(x)$ and $f^{(3)}(x)$ and $\frac{d^3 f}{dx^3}(x)$ all mean $\frac{d}{dx}\left(\frac{d}{dx}\left(\frac{d}{dx}f(x)\right)\right)$
- $f^{(4)}(x)$ and $\frac{d^4 f}{dx^4}(x)$ both mean $\frac{d}{dx}\left(\frac{d}{dx}\left(\frac{d}{dx}\left(\frac{d}{dx}f(x)\right)\right)\right)$
- and so on.

¹⁴ This is typical mathematician speak — it allows us to be completely correct, without being terribly precise. In this context, “sufficiently close” means “The following need not be true for all t bigger than c , but there must exist some $b > c$ so that the following is true for all $c < t < b$ ”. Typically we do not know what b is. And typically it does not matter what the exact value of b is. All that matters is that b exists and is strictly bigger than c .

Here is a simple example.

Example 3.4.2

Let n be a natural number and let $f(x) = x^n$. Then

$$\begin{aligned}\frac{d}{dx}x^n &= nx^{n-1} \\ \frac{d^2}{dx^2}x^n &= \frac{d}{dx}(nx^{n-1}) = n(n-1)x^{n-2} \\ \frac{d^3}{dx^3}x^n &= \frac{d}{dx}(n(n-1)x^{n-2}) = n(n-1)(n-2)x^{n-3}\end{aligned}$$

Each time we differentiate, we bring down the exponent, which is exactly one smaller than the previous exponent brought down, and we reduce the exponent by one. By the time we have differentiated $n - 1$ times, the exponent has decreased to $n - (n - 1) = 1$ and we have brought down the factors $n(n - 1)(n - 2) \cdots 2$. So

$$\frac{d^{n-1}}{dx^{n-1}}x^n = n(n-1)(n-2) \cdots 2x$$

and

$$\frac{d^n}{dx^n}x^n = n(n-1)(n-2) \cdots 1$$

The product of the first n natural numbers, $1 \cdot 2 \cdot 3 \cdots n$, is called “ n factorial” and is denoted $n!$. So we can also write

$$\frac{d^n}{dx^n}x^n = n!$$

If $m > n$, then

$$\frac{d^m}{dx^m}x^n = 0$$

Example 3.4.2

What is the significance of higher order derivatives?

Here is a bit of thinking about second order derivatives in the context of rates of change.

Example 3.4.3

Recall that the derivative $v'(a)$ is the (instantaneous) rate of change of the function $v(t)$ at $t = a$. Suppose that you are walking on the x -axis and that $x(t)$ is your x -coordinate at time t . Also suppose, for simplicity, that you are moving from left to right. Then $v(t) = x'(t)$ is your velocity at time t and $v'(a) = x''(a)$ is the rate at which your velocity is changing at time $t = a$. It is called your acceleration. In particular, if $x''(a) > 0$, then your velocity is increasing, i.e. you are speeding up, at time a . If $x''(a) < 0$, then your velocity is decreasing, i.e. you are slowing down, at time a . That's one interpretation of the second derivative.

Example 3.4.3

3.5 ▲ Derivatives of exponential functions

Learning Objectives

- Use the definition of the derivative to show that the derivative of the function $f(x) = a^x$ (where a is a positive constant) is a constant times a^x .
- Describe the exponential function e^x in terms of its derivative.
- Note the useful modelling power of a function whose derivative is proportional to itself.

In this section we show how to compute the derivative of the exponential function. Let $a > 0$ ¹⁵ and set $f(x) = a^x$ — this is what is known as an exponential function with base a . This function interacts very nicely with its derivative and turns up in many “real world” examples.

Let’s see what happens when we try to compute the derivative of this function just using the definition of the derivative.

$$\begin{aligned} \frac{df}{dx} &= \lim_{h \rightarrow 0} \frac{f(x+h) - f(x)}{h} = \lim_{h \rightarrow 0} \frac{a^{x+h} - a^x}{h} \\ &= \lim_{h \rightarrow 0} a^x \cdot \frac{a^h - 1}{h} = a^x \cdot \lim_{h \rightarrow 0} \frac{a^h - 1}{h} \end{aligned}$$

We cannot yet complete this computation because we cannot evaluate the last limit directly. For the moment, let us assume this limit exists and name it

$$C(a) = \lim_{h \rightarrow 0} \frac{a^h - 1}{h}.$$

It depends only on a and on h and is completely independent of x . Using this notation (which we will quickly improve upon below), our desired derivative is now

$$\frac{d}{dx} a^x = C(a) \cdot a^x.$$

Thus the derivative of an exponential function a^x is just a^x multiplied by some constant that depends only on the base a . If we can tune a so that $C(a) = 1$ then the derivative would just be the original function! This turns out to be very useful.

To try finding an a that obeys $C(a) = 1$, let us first investigate how $C(a)$ changes with a . Unfortunately (though this fact is not at all obvious) there is no way to write $C(a)$ as a finite combination of any of the functions we have examined so far¹⁶. Instead, we’ll calculate approximate values of $C(a)$ by plugging in some small values of h . We’ll do this for a few values of a .

15 Letting the base be positive is necessary because we want to ensure this function is defined for all real x .

16 To be a bit more precise, we say that a number q is algebraic if we can write q as the zero of a polynomial with integer coefficients. When a is any positive algebraic number other than 1, $C(a)$ is not algebraic. A number that is not algebraic is called transcendental. The best known example of a transcendental number is π (which follows from the Lindemann-Weierstrass Theorem — way beyond the scope of this course).

Example 3.5.1

Let $a = 1$, then $C(1) = \lim_{h \rightarrow 0} \frac{1^h - 1}{h} = 0$. This is not surprising since $1^x = 1$ is constant, and so its derivative must be zero everywhere.

Now let $a = 2$, then $C(2) = \lim_{h \rightarrow 0} \frac{2^h - 1}{h}$. Setting h to smaller and smaller numbers gives:

h	0.1	0.01	0.001	0.0001	0.00001	0.000001	0.0000001
$\frac{2^h - 1}{h}$	0.7177	0.6956	0.6934	0.6932	0.6931	0.6931	0.6931

So $C(2) \approx 0.6931$. (The actual value of $C(2)$ has an infinitely long decimal expansion.) Similarly when $a = 3$ we get:

h	0.1	0.01	0.001	0.0001	0.00001	0.000001	0.0000001
$\frac{3^h - 1}{h}$	1.1612	1.1047	1.0992	1.0987	1.0986	1.0986	1.0986

and $a = 10$:

h	0.1	0.01	0.001	0.0001	0.00001	0.000001	0.0000001
$\frac{10^h - 1}{h}$	2.5893	2.3293	2.3052	2.3028	2.3026	2.3026	2.3026

So $C(3) \approx 1.0986$ and $C(10) \approx 2.3026$.

From our calculations it appears that $C(a)$ increases as we increase a , and we expect that $C(a) = 1$ for some value of a between 2 and 3.

Example 3.5.1

Instead of continuing to write ‘the value of a for which $C(a) = 1$ ’, this particular a is historically given its own name: e . To find a value for e , we begin with $C(e) = 1$:

$$C(e) = \lim_{h \rightarrow 0} \frac{e^h - 1}{h} = 1.$$

This means that for small h ,

$$\frac{e^h - 1}{h} \approx 1,$$

so that

$$e^h - 1 \approx h \Rightarrow e^h \approx h + 1 \Rightarrow e \approx (1 + h)^{1/h}.$$

More formally, we would write that

$$e = \lim_{h \rightarrow 0} (1 + h)^{1/h}. \tag{3.5.1}$$

We can find an approximate decimal expansion for e by calculating the expression in Eqn. (3.5.1) for some very small (but finite value) of h .

h	0.1	0.01	0.001	0.0001	0.00001
$(1 + h)^{1/h}$	2.5937425	2.7048138	2.7169239	2.7181459	2.7182682

We find (e.g. for $h = 0.00001$) that

$$e \approx (1.00001)^{100000} \approx 2.71826,$$

which is not too bad. In fact, e is called Euler's constant¹⁷:

Equation 3.5.2 (Euler's constant).

$$\begin{aligned} e &= 2.7182818284590452354\dots \\ &= 1 + \frac{1}{1!} + \frac{1}{2!} + \frac{1}{3!} + \frac{1}{4!} + \dots \end{aligned} \quad ^{18}$$

We will be able to explain this last formula once we develop Taylor polynomials later in the course.

To summarise:

Theorem 3.5.3.

The constant e is the unique real number that satisfies¹⁹

$$\lim_{h \rightarrow 0} \frac{e^h - 1}{h} = 1.$$

Further,

$$\frac{d}{dx}(e^x) = e^x.$$

We plot e^x in the graph below.

17 Unfortunately there is another Euler's constant, γ , which is more properly called the Euler–Mascheroni constant. Anyway like many mathematical discoveries, e was first found by someone else — Napier used the constant e in order to compute logarithms but only implicitly. Bernoulli was probably the first to approximate it when examining continuous compound interest. It first appeared explicitly in work of Leibniz, though he denoted it b . It was Euler, though, who established the notation we now use and who showed how important the constant is to mathematics.

18 Recall n factorial, written $n!$ is the product $n \times (n-1) \times (n-2) \times \dots \times 2 \times 1$.

19 Equivalently, e can be defined as $e = \lim_{h \rightarrow 0} (1+h)^{1/h}$ or as $e = \lim_{n \rightarrow \infty} (1 + \frac{1}{n})^n$.

Figure 3.5.1.

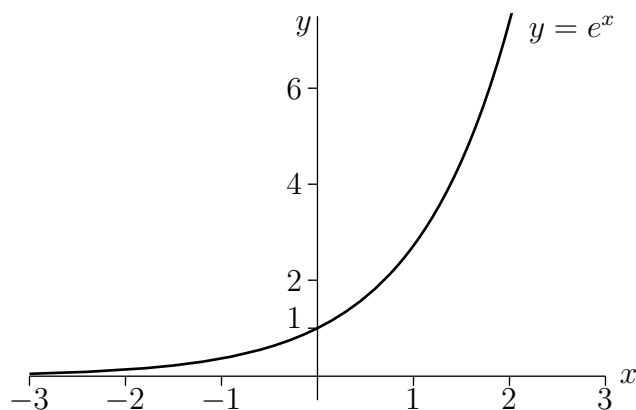

And just a reminder of some of its properties²⁰...

1. $e^{x+y} = e^x e^y$.
2. $e^{-x} = \frac{1}{e^x}$.
3. $(e^x)^y = e^{xy}$.
4. e^x is a function that is defined, continuous, and differentiable for all real numbers x .
5. $e^0 = 1$, and $e^1 = e$.
6. $e^x > 0$ for all values of x .
7. $\lim_{x \rightarrow \infty} e^x = \infty$, $\lim_{x \rightarrow -\infty} e^x = 0$.
8. The derivative of e^x is e^x .

Example 3.5.4

Find the derivative of e^x when $x = 0$. Then show that the tangent line at that point is the line $y = x + 1$.

- The derivative of e^x is e^x . At $x = 0$, $e^0 = 1$.
- The slope of the tangent line at $x = 0$ is the derivative of the function at that point, which we just found to be 1. The tangent line goes through the point $(0, e^0) = (0, 1)$. With slope 1 and an intercept at $(0, 1)$, the tangent line at $x = 0$ can be written in slope-intercept form as $y = x + 1$.

Example 3.5.4

²⁰ The function e^x is of course the special case of the function a^x with $a = e$. So it inherits all the usual algebraic properties of a^x .

 To see the tangent line to the exponential function: On this graph of $f(x) = e^x$, add the tangent line $y = x + 1$. Does it touch the curve where you expect it to? As an extra step, add a generic tangent line at any point x_0 . Adjust a slider for x_0 to see how the tangent line changes as it moves along the curve.

In the next chapter, we return to the problem of differentiating a^x . (If your curiosity is piqued, take a look at Example 4.4.6 – although you’ll need the techniques introduced between here and there in order to understand it.)

►► The function e^x satisfies a new kind of equation

Before closing this chapter, we divert our attention momentarily to an interesting observation. We have seen that the function

$$y = f(x) = e^x$$

satisfies the relationship

$$\frac{dy}{dx} = f'(x) = f(x) = y.$$

In other words, when differentiating, we get the same function back again. We can summarize this observation:

Definition 3.5.5.

The function $y = f(x) = e^x$ is equal to its own derivative, which means that it satisfies the equation

$$\frac{dy}{dx} = y.$$

An equation linking a function and its derivative(s) is called a **differential equation**.

This is a new type of equation, unlike others previously seen in this course. They feature highly in some of the later (flavoured) chapters of this text, where we show that these differential equations have many applications to biology, physics, chemistry, and science in general.

COMPUTING DERIVATIVES

4.1 ▲ Arithmetic of derivatives - a differentiation toolbox

Learning Objectives

- Demonstrate using the limit definition of derivative that differentiation is linear.
- Use linearity to “break down” derivatives of sums and constant multiples.
- Use counterexamples to demonstrate that certain statements about derivatives are false.
- Explain why an example does not constitute a “proof”.
- Demonstrate the Power Rule for integer exponents using the limit definition of derivative.
- State and apply the Power Rule.
- Use the Product Rule to differentiate the product of functions.
- Use the Quotient Rule to differentiate the quotient of functions.

So far, we have evaluated derivatives only by applying Definition 3.3.3 to the function at hand and then computing the required limits directly. It is quite obvious that as the function being differentiated becomes even a little complicated, this procedure quickly becomes extremely unwieldy. It is many orders of magnitude more efficient to have access to:

- a list of derivatives of some simple functions, and
- a collection of rules for breaking down complicated derivative computations into sequences of simple derivative computations.

This is precisely what we did to compute limits. We started with limits of simple functions and then used “arithmetic of limits” to compute limits of complicated functions.

We have already started building our list of derivatives of simple functions. We have shown, in Examples 3.3.4, 3.3.5, 3.3.10 and 3.3.14, that:

$$\frac{d}{dx}1 = 0, \quad \frac{d}{dx}x = 1, \quad \frac{d}{dx}x^2 = 2x, \quad \frac{d}{dx}\sqrt{x} = \frac{1}{2\sqrt{x}}.$$

We’ll expand this list later.

We now start building a collection of tools that help reduce the problem of computing the derivative of a complicated function to that of computing the derivatives of a number of simple functions. In this section we give three derivative “rules” as three separate theorems. We’ll give the proofs of these theorems in the next section and examples of how they are used in the following section.

As was the case for limits, derivatives interact very cleanly with addition, subtraction and multiplication by a constant. The following result actually follows very directly from the first three points of Theorem 2.1.15.

Lemma 4.1.1 (Derivative of sum and difference).

Let $f(x), g(x)$ be differentiable functions and let $c \in \mathbb{R}$ be a constant. Then

$$\begin{aligned} \frac{d}{dx}\{f(x) + g(x)\} &= f'(x) + g'(x), \\ \frac{d}{dx}\{f(x) - g(x)\} &= f'(x) - g'(x), \\ \frac{d}{dx}\{cf(x)\} &= cf'(x). \end{aligned}$$

That is, the derivative of the sum is the sum of the derivatives, and so forth.

Following this we can combine the three statements in this lemma into a single rule which captures the “linearity of differentiation”.

Theorem 4.1.2 (Linearity of differentiation).

Again, let $f(x), g(x)$ be differentiable functions, let $\alpha, \beta \in \mathbb{R}$ be constants and define the “linear combination”

$$S(x) = \alpha f(x) + \beta g(x).$$

Then the derivative of $S(x)$ at $x = a$ exists and is

$$\frac{dS}{dx} = S'(x) = \alpha f'(x) + \beta g'(x).$$

Note that we can recover the three rules in the previous lemma by setting $\alpha = \beta = 1$ or $\alpha = 1, \beta = -1$ or $\alpha = c, \beta = 0$.

Unfortunately, the derivative does not act quite as simply on products or quotients. The rules for computing derivatives of products and quotients get their own names and theorems:

Theorem 4.1.3 (The product rule).

Let $f(x), g(x)$ be differentiable functions, then the derivative of the product $f(x)g(x)$ exists and is given by

$$\frac{d}{dx}\{f(x)g(x)\} = f'(x)g(x) + f(x)g'(x).$$

Before we proceed to the derivative of the ratio of two functions, it is worth noting a special case of the product rule when $g(x) = f(x)$. In fact, since this is a useful special case, let us call it a corollary¹:

Corollary 4.1.4 (Derivative of a square).

Let $f(x)$ be a differentiable function, then the derivative of its square is

$$\frac{d}{dx}\{f(x)^2\} = 2f(x)f'(x).$$

With a little work this can be generalised to other powers — but that is best done once we understand how to compute the derivative of the composition of two functions. That requires the chain rule (see Theorem 4.3.2 below). But before we get to that, we need to see how to take the derivative of a quotient of two functions.

Theorem 4.1.5 (The quotient rule).

Let $f(x), g(x)$ be differentiable functions. Then the derivative of their quotient is

$$\frac{d}{dx}\left\{\frac{f(x)}{g(x)}\right\} = \frac{f'(x)g(x) - f(x)g'(x)}{g(x)^2}.$$

This derivative exists except at points where $g(x) = 0$.

So we have covered sums, differences, products and quotients. This allows us to compute derivatives of many different functions — including polynomials and rational functions. However we are still missing trigonometric functions (for example), and a rule for computing derivatives of compositions of functions. These will follow in the near future, but there are a couple of things to do before that: understand where the above theorems come from, and practice using them.

¹ Recall that a corollary is an important result that follows from one or more theorems — typically without too much extra work — as is the case here.

▲ Proofs of the arithmetic of derivatives

The theorems of the previous section are not too difficult to prove from the definition of the derivative (which we know) and the arithmetic of limits (which we also know). In this section we show how to construct these rules.

Throughout this section we will use our two functions $f(x)$ and $g(x)$. Since the theorems we are going to prove all express derivatives of linear combinations, products and quotients in terms of f, g and their derivatives, it is helpful to recall the definitions of the derivatives of f and g :

$$f'(x) = \lim_{h \rightarrow 0} \frac{f(x+h) - f(x)}{h} \quad \text{and} \quad g'(x) = \lim_{h \rightarrow 0} \frac{g(x+h) - g(x)}{h}.$$

Our proofs, roughly speaking, involve doing algebraic manipulations to uncover the expressions that look like the above.

►► Proof of the linearity of differentiation (Theorem 4.1.2)

Recall that in Theorem 4.1.2 we defined $S(x) = \alpha f(x) + \beta g(x)$, where $\alpha, \beta \in \mathbb{R}$ are constants. We wish to compute $S'(x)$, so we start with the definition:

$$S'(x) = \lim_{h \rightarrow 0} \frac{S(x+h) - S(x)}{h}.$$

Let us concentrate on the numerator of the expression inside the limit and then come back to the full limit in a moment. Substitute in the definition of $S(x)$:

$$\begin{aligned} S(x+h) - S(x) &= [\alpha f(x+h) + \beta g(x+h)] - [\alpha f(x) + \beta g(x)] && \text{collect terms} \\ &= \alpha [f(x+h) - f(x)] + \beta [g(x+h) - g(x)]. \end{aligned}$$

Now it is easy to see the structures we need — namely, we almost have the expressions for the derivatives $f'(x)$ and $g'(x)$. Indeed, all we need to do is divide by h and take the limit. So let's finish things off.

$$\begin{aligned} S'(x) &= \lim_{h \rightarrow 0} \frac{S(x+h) - S(x)}{h} && \text{from above} \\ &= \lim_{h \rightarrow 0} \frac{\alpha [f(x+h) - f(x)] + \beta [g(x+h) - g(x)]}{h} \\ &= \lim_{h \rightarrow 0} \left[\alpha \frac{f(x+h) - f(x)}{h} + \beta \frac{g(x+h) - g(x)}{h} \right] && \text{limit laws} \\ &= \alpha \lim_{h \rightarrow 0} \frac{f(x+h) - f(x)}{h} + \beta \lim_{h \rightarrow 0} \frac{g(x+h) - g(x)}{h} \\ &= \alpha f'(x) + \beta g'(x), \end{aligned}$$

as required.

►► Proof of the product rule (Theorem 4.1.3)

After the warm-up above, we will just jump straight in. Let $P(x) = f(x)g(x)$, the product of our two functions. The derivative of the product is given by

$$P'(x) = \lim_{h \rightarrow 0} \frac{P(x+h) - P(x)}{h}$$

Again we will focus on the numerator inside the limit and massage it into the form we need. To simplify these manipulations, define

$$F(h) = \frac{f(x+h) - f(x)}{h} \quad \text{and} \quad G(h) = \frac{g(x+h) - g(x)}{h}.$$

Then we can write

$$f(x+h) = f(x) + hF(h) \quad \text{and} \quad g(x+h) = g(x) + hG(h).$$

We can also write

$$f'(x) = \lim_{h \rightarrow 0} F(h) \quad \text{and} \quad g'(x) = \lim_{h \rightarrow 0} G(h).$$

So back to that numerator:

$$\begin{aligned} P(x+h) - P(x) &= f(x+h) \cdot g(x+h) - f(x) \cdot g(x) && \text{substitute} \\ &= [f(x) + hF(h)] [g(x) + hG(h)] - f(x) \cdot g(x) && \text{expand} \\ &= f(x)g(x) + f(x) \cdot hG(h) + hF(h) \cdot g(x) + h^2F(h) \cdot G(h) - f(x) \cdot g(x) \\ &= f(x) \cdot hG(h) + hF(h) \cdot g(x) + h^2F(h) \cdot G(h). \end{aligned}$$

Armed with this we return to the definition of the derivative:

$$\begin{aligned} P'(x) &= \lim_{h \rightarrow 0} \frac{P(x+h) - P(x)}{h} \\ &= \lim_{h \rightarrow 0} \frac{f(x) \cdot hG(h) + hF(h) \cdot g(x) + h^2F(h) \cdot G(h)}{h} \\ &= \left(\lim_{h \rightarrow 0} \frac{f(x) \cdot hG(h)}{h} \right) + \left(\lim_{h \rightarrow 0} \frac{hF(h) \cdot g(x)}{h} \right) + \left(\lim_{h \rightarrow 0} \frac{h^2F(h) \cdot G(h)}{h} \right) \\ &= \left(\lim_{h \rightarrow 0} f(x) \cdot G(h) \right) + \left(\lim_{h \rightarrow 0} F(h) \cdot g(x) \right) + \left(\lim_{h \rightarrow 0} hF(h) \cdot G(h) \right). \end{aligned}$$

Now since $f(x)$ and $g(x)$ do not change as we send h to zero, we can pull them outside. We can also write the third term as the product of 3 limits:

$$\begin{aligned} &= \left(f(x) \lim_{h \rightarrow 0} G(h) \right) + \left(g(x) \lim_{h \rightarrow 0} F(h) \right) + \left(\lim_{h \rightarrow 0} h \right) \cdot \left(\lim_{h \rightarrow 0} F(h) \right) \cdot \left(\lim_{h \rightarrow 0} G(h) \right) \\ &= f(x) \cdot g'(x) + g(x) \cdot f'(x) + 0 \cdot f'(x) \cdot g'(x) \\ &= f(x) \cdot g'(x) + g(x) \cdot f'(x). \end{aligned}$$

And so we recover the product rule.

►► (optional) — Proof of the quotient rule (Theorem 4.1.5)

We now give the proof of the quotient rule in two steps². We assume throughout that $g(x) \neq 0$ and that $f(x)$ and $g(x)$ are differentiable, meaning that the limits defining $f'(x)$, $g'(x)$ exist.

- In the first step, we prove the quotient rule under the assumption that $f(x)/g(x)$ is differentiable.
- In the second step, we prove that $1/g(x)$ is differentiable. Once we know that $1/g(x)$ is differentiable, the product rule implies that $f(x)/g(x)$ is differentiable.

Step 1: the proof of the quotient rule assuming that $\frac{f(x)}{g(x)}$ is differentiable. Write $Q(x) = \frac{f(x)}{g(x)}$. Then $f(x) = g(x)Q(x)$ so that $f'(x) = g'(x)Q(x) + g(x)Q'(x)$, by the product rule, and

$$\begin{aligned} Q'(x) &= \frac{f'(x) - g'(x)Q(x)}{g(x)} = \frac{f'(x) - g'(x)\frac{f(x)}{g(x)}}{g(x)} \\ &= \frac{f'(x)g(x) - f(x)g'(x)}{g(x)^2}. \end{aligned}$$

Step 2: the proof that $1/g(x)$ is differentiable. By definition

$$\begin{aligned} \frac{d}{dx} \frac{1}{g(x)} &= \lim_{h \rightarrow 0} \frac{1}{h} \left[\frac{1}{g(x+h)} - \frac{1}{g(x)} \right] = \lim_{h \rightarrow 0} \frac{g(x) - g(x+h)}{hg(x)g(x+h)} \\ &= - \lim_{h \rightarrow 0} \frac{1}{g(x)} \frac{1}{g(x+h)} \frac{g(x+h) - g(x)}{h} \\ &= - \frac{1}{g(x)} \lim_{h \rightarrow 0} \frac{1}{g(x+h)} \lim_{h \rightarrow 0} \frac{g(x+h) - g(x)}{h} \\ &= - \frac{1}{g(x)^2} g'(x). \end{aligned}$$

▲ Using the arithmetic of derivatives: Examples

In this section we illustrate the computation of derivatives using the arithmetic of derivatives — Theorems 4.1.2, 4.1.3 and 4.1.5. To make it clear which rules we are using during the examples we will note which theorem we are using:

- LIN to stand for “linearity” $\frac{d}{dx} \{ \alpha f(x) + \beta g(x) \} = \alpha f'(x) + \beta g'(x)$ Theorem 4.1.2
- PR to stand for “product rule” $\frac{d}{dx} \{ f(x)g(x) \} = f'(x)g(x) + f(x)g'(x)$ Theorem 4.1.3
- QR to stand for “quotient rule” $\frac{d}{dx} \left\{ \frac{f(x)}{g(x)} \right\} = \frac{f'(x)g(x) - f(x)g'(x)}{g(x)^2}$ Theorem 4.1.5

² We thank Serban Raianu for suggesting this approach.

We'll start with a really easy example.

Example 4.1.6

$$\begin{aligned}\frac{d}{dx}\{4x+7\} &= 4 \cdot \frac{d}{dx}\{x\} + 7 \cdot \frac{d}{dx}\{1\} && \text{LIN} \\ &= 4 \cdot 1 + 7 \cdot 0 = 4\end{aligned}$$

where we have used LIN with $f(x) = x$, $g(x) = 1$, $\alpha = 4$, $\beta = 7$.

Example 4.1.6

Example 4.1.7

Continuing on from the previous example, we can use the product rule and the previous result to compute

$$\begin{aligned}\frac{d}{dx}\{x(4x+7)\} &= x \cdot \frac{d}{dx}\{4x+7\} + (4x+7) \frac{d}{dx}\{x\} && \text{PR} \\ &= x \cdot 4 + (4x+7) \cdot 1 \\ &= 8x+7\end{aligned}$$

where we have used the product rule PR with $f(x) = x$ and $g(x) = 4x+7$.

Example 4.1.7

Example 4.1.8

In the same vein as the previous example, we can use the quotient rule to compute

$$\begin{aligned}\frac{d}{dx}\left\{\frac{x}{4x+7}\right\} &= \frac{(4x+7) \cdot \frac{d}{dx}\{x\} - x \cdot \frac{d}{dx}\{4x+7\}}{(4x+7)^2} && \text{QR} \\ &= \frac{(4x+7) \cdot 1 - x \cdot 4}{(4x+7)^2} \\ &= \frac{7}{(4x+7)^2}\end{aligned}$$

where we have used the quotient rule QR with $f(x) = x$ and $g(x) = 4x+7$.

Example 4.1.8

Now for a messier example.

Example 4.1.9

Differentiate:

$$f(x) = \frac{x}{2x + \frac{1}{3x+1}}$$

This problem looks nasty. But it isn't so hard if we just build it up a bit at a time.

- First, $f(x)$ is the ratio of

$$f_1(x) = x \quad \text{and} \quad f_2(x) = 2x + \frac{1}{3x+1}.$$

If we can find the derivatives of $f_1(x)$ and $f_2(x)$, we will be able to get the derivative of $f(x)$ just by applying the quotient rule. The derivative, $f_1'(x) = 1$, of $f_1(x)$ is easy, so let's work on $f_2(x)$.

- The function $f_2(x)$ is the linear combination

$$f_2(x) = 2f_3(x) + f_4(x) \quad \text{with} \quad f_3(x) = x \quad \text{and} \quad f_4(x) = \frac{1}{3x+1}.$$

If we can find the derivatives of $f_3(x)$ and $f_4(x)$, we will be able to get the derivative of $f_2(x)$ just by applying linearity (Theorem 4.1.2). The derivative, $f_3'(x) = 1$, of $f_3(x)$ is easy. So let's work on $f_4(x)$.

- The function $f_4(x)$ is the ratio

$$f_4(x) = \frac{1}{f_5(x)} \quad \text{with} \quad f_5(x) = 3x + 1.$$

If we can find the derivative of $f_5(x)$, we will be able to get the derivative of $f_4(x)$ by applying the quotient rule to $\frac{1}{f_5(x)}$ ³. The derivative of $f_5(x)$ is easy.

- So we have completed breaking down $f(x)$ into easy pieces. It is now just a matter of reversing the break down steps, putting everything back together, starting with the easy pieces and working up to $f(x)$. Here goes.

$$f_5(x) = 3x + 1 \quad \text{so} \quad \frac{d}{dx} f_5(x) = 3 \frac{d}{dx} x + \frac{d}{dx} 1 = 3 \cdot 1 + 0 = 3 \quad \text{LIN}$$

$$f_4(x) = \frac{1}{f_5(x)} \quad \text{so} \quad \frac{d}{dx} f_4(x) = -\frac{f_5'(x)}{f_5(x)^2} = -\frac{3}{(3x+1)^2} \quad \text{QR}$$

$$f_2(x) = 2f_3(x) + f_4(x) \quad \text{so} \quad \frac{d}{dx} f_2(x) = 2f_3'(x) + f_4'(x) = 2 - \frac{3}{(3x+1)^2} \quad \text{LIN}$$

$$\begin{aligned} f(x) = \frac{f_1(x)}{f_2(x)} \quad \text{so} \quad \frac{d}{dx} f(x) &= \frac{f_1'(x)f_2(x) - f_1(x)f_2'(x)}{f_2(x)^2} && \text{QR} \\ &= \frac{1 \left[2x + \frac{1}{3x+1} \right] - x \left[2 - \frac{3}{(3x+1)^2} \right]}{\left[2x + \frac{1}{3x+1} \right]^2} \end{aligned}$$

Oof!

3 This is an instance of a special case of the quotient rule (Theorem 4.1.5) which is obtained by setting $f(x) = 1$. You might see this defined elsewhere as “the derivative of a reciprocal”. It can be stated as: Let $g(x)$ be a differentiable function. Then the derivative of the reciprocal of g is given by

$$\frac{d}{dx} \left\{ \frac{1}{g(x)} \right\} = -\frac{g'(x)}{g(x)^2}$$

and exists except at those points where $g(x) = 0$.

- We now have an answer. But we really should clean it up, not only to make it easier to read, but also because invariably such computations are just small steps inside much larger computations. Any future computations involving this expression will be a lot easier and less error prone if we clean it up now. Cancelling the $2x$ and the $-2x$ in

$$\begin{aligned} 1\left[2x + \frac{1}{3x+1}\right] - x\left[2 - \frac{3}{(3x+1)^2}\right] &= 2x + \frac{1}{3x+1} - 2x + \frac{3x}{(3x+1)^2} \\ &= \frac{1}{3x+1} + \frac{3x}{(3x+1)^2} \end{aligned}$$

and multiplying both the numerator and denominator by $(3x+1)^2$ gives

$$\begin{aligned} f'(x) &= \frac{\frac{1}{3x+1} + \frac{3x}{(3x+1)^2}}{\left[2x + \frac{1}{3x+1}\right]^2} \frac{(3x+1)^2}{(3x+1)^2} \\ &= \frac{(3x+1) + 3x}{[2x(3x+1) + 1]^2} \\ &= \frac{6x+1}{[6x^2 + 2x + 1]^2}. \end{aligned}$$

Example 4.1.9

While the linearity theorem (Theorem 4.1.2) is stated for a linear combination of two functions, it is not difficult to extend it to linear combinations of three or more functions as the following example shows.

Example 4.1.10

We'll start by generalising linearity to three functions.

$$\begin{aligned} \frac{d}{dx}\{aF(x) + bG(x) + cH(x)\} &= \frac{d}{dx}\{a \cdot [F(x)] + 1 \cdot [bG(x) + cH(x)]\} \\ &= aF'(x) + \frac{d}{dx}\{bG(x) + cH(x)\} \\ &\quad \text{by LIN with } \alpha = a, f(x) = F(x), \beta = 1, \\ &\quad \text{and } g(x) = bG(x) + cH(x), \\ &= aF'(x) + bG'(x) + cH'(x) \\ &\quad \text{by LIN with } \alpha = b, f(x) = G(x), \beta = c, \\ &\quad \text{and } g(x) = H(x). \end{aligned}$$

This gives us linearity for three terms, namely (just replacing upper case names by lower case names):

$$\frac{d}{dx}\{af(x) + bg(x) + ch(x)\} = af'(x) + bg'(x) + ch'(x).$$

Just by repeating the above argument many times, we may generalise to linearity for n terms, for any natural number n :

$$\frac{d}{dx}\{a_1f_1(x) + a_2f_2(x) + \cdots + a_nf_n(x)\} = a_1f_1'(x) + a_2f_2'(x) + \cdots + a_nf_n'(x).$$

Example 4.1.10

Similarly, while the product rule is stated for the product of two functions, it is not difficult to extend it to the product of three or more functions as the following example shows.

Example 4.1.11

Once again, we'll start by generalising the product rule to three factors.

$$\begin{aligned} \frac{d}{dx}\{F(x)G(x)H(x)\} &= F'(x)G(x)H(x) + F(x)\frac{d}{dx}\{G(x)H(x)\} \\ &\quad \text{by PR with } f(x) = F(x) \text{ and } g(x) = G(x)H(x) \\ &= F'(x)G(x)H(x) + F(x)\{G'(x)H(x) + G(x)H'(x)\} \\ &\quad \text{by PR with } f(x) = G(x) \text{ and } g(x) = H(x). \end{aligned}$$

This gives us a product rule for three factors, namely (just replacing upper case names by lower case names)

$$\frac{d}{dx}\{f(x)g(x)h(x)\} = f'(x)g(x)h(x) + f(x)g'(x)h(x) + f(x)g(x)h'(x).$$

Observe that when we differentiate a product of three factors, the answer is a sum of three terms and in each term the derivative acts on exactly one of the original factors. Just by repeating the above argument many times, we may generalise the product rule to give the derivative of a product of n factors, for any natural number n :

$$\begin{aligned} \frac{d}{dx}\{f_1(x)f_2(x)\cdots f_n(x)\} &= f_1'(x)f_2(x)\cdots f_n(x) \\ &\quad + f_1(x)f_2'(x)\cdots f_n(x) \\ &\quad \vdots \\ &\quad + f_1(x)f_2(x)\cdots f_n'(x). \end{aligned}$$

We can also write the above as

$$\frac{d}{dx}\{f_1(x)f_2(x)\cdots f_n(x)\} = \left[\frac{f_1'(x)}{f_1(x)} + \frac{f_2'(x)}{f_2(x)} + \cdots + \frac{f_n'(x)}{f_n(x)} \right] \cdot f_1(x)f_2(x)\cdots f_n(x).$$

When we differentiate a product of n factors, the answer is a sum of n terms and in each term the derivative acts on exactly one of the original factors. In the first term, the derivative acts on the first of the original factors. In the second term, the derivative acts on the second of the original factors. And so on.

If we make $f_1(x) = f_2(x) = \cdots = f_n(x) = f(x)$ then each of the n terms on the right hand side of the above equation is the product of $f'(x)$ and exactly $n - 1$ $f(x)$'s, and so is exactly $f(x)^{n-1} f'(x)$. So we get the following useful result:

$$\frac{d}{dx} f(x)^n = n \cdot f(x)^{n-1} \cdot f'(x).$$

Example 4.1.11

This last result is quite useful, so let us write it as a lemma for future reference.

Lemma 4.1.12.

Let n be a natural number and f be a differentiable function. Then

$$\frac{d}{dx} f(x)^n = n \cdot f(x)^{n-1} \cdot f'(x)$$

This immediately gives us another useful result.

Example 4.1.13

We can now compute the derivative of x^n for any natural number n . Start with Lemma 4.1.12 and substitute $f(x) = x$ and $f'(x) = 1$:

$$\frac{d}{dx} x^n = n \cdot x^{n-1} \cdot 1 = nx^{n-1}.$$

Example 4.1.13

Again — this is a result we will come back to quite a few times in the future, so we should make sure we can refer to it easily. However, at present this statement only holds when n is a positive integer. With a little more work we can extend this to compute x^q where q is any positive rational number and then any rational number at all (positive or negative). So let us hold off for a little longer. Instead we can make it a lemma, since it will be an ingredient in quite a few of the examples following below and in constructing the final corollary.

Lemma 4.1.14 (Derivative of x^n).

Let n be a positive integer then

$$\frac{d}{dx} x^n = nx^{n-1} \tag{4.1.1}$$

Back to more examples.

Example 4.1.15

$$\frac{d}{dx}\{2x^3 + 4x^5\} = 2\frac{d}{dx}\{x^3\} + 4\frac{d}{dx}\{x^5\}$$

by LIN with $\alpha = 2$, $f(x) = x^3$, $\beta = 4$, and $g(x) = x^5$

$$= 2\{3x^2\} + 4\{5x^4\}$$

by Lemma 4.1.14, once with $n = 3$, and once with $n = 5$

$$= 6x^2 + 20x^4.$$

Example 4.1.15

Example 4.1.16

In this example we'll compute $\frac{d}{dx}\{(3x+9)(x^2+4x^3)\}$ in two different ways. For the first, we'll start with the product rule.

$$\begin{aligned} \frac{d}{dx}\{(3x+9)(x^2+4x^3)\} &= \left\{\frac{d}{dx}(3x+9)\right\}(x^2+4x^3) + (3x+9)\frac{d}{dx}\{x^2+4x^3\} \\ &= \{3 \times 1 + 9 \times 0\}(x^2+4x^3) + (3x+9)\{2x+4(3x^2)\} \\ &= 3(x^2+4x^3) + (3x+9)(2x+12x^2) \\ &= 3x^2 + 12x^3 + (6x^2 + 18x + 36x^3 + 108x^2) \\ &= 18x + 117x^2 + 48x^3. \end{aligned}$$

For the second, we expand the product first and then differentiate.

$$\begin{aligned} \frac{d}{dx}\{(3x+9)(x^2+4x^3)\} &= \frac{d}{dx}\{9x^2 + 39x^3 + 12x^4\} \\ &= 9(2x) + 39(3x^2) + 12(4x^3) \\ &= 18x + 117x^2 + 48x^3. \end{aligned}$$

Example 4.1.16

Example 4.1.17

$$\frac{d}{dx} \left\{ \frac{4x^3 - 7x}{4x^2 + 1} \right\} = \frac{(12x^2 - 7)(4x^2 + 1) - (4x^3 - 7x)(8x)}{(4x^2 + 1)^2}$$

by QR with $f(x) = 4x^3 - 7x$, $f'(x) = 12x^2 - 7$,

and $g(x) = 4x^2 + 1$, $g'(x) = 8x$

$$= \frac{(48x^4 - 16x^2 - 7) - (32x^4 - 56x^2)}{(4x^2 + 1)^2}$$

$$= \frac{16x^4 + 40x^2 - 7}{(4x^2 + 1)^2}.$$

Example 4.1.17

Example 4.1.18

In this example, we'll use a little trickery to find the derivative of $\sqrt[3]{x}$. The trickery consists of observing that, by the definition of the cube root,

$$x = (\sqrt[3]{x})^3.$$

Since both sides of the expression are the same, they must have the same derivatives:

$$\frac{d}{dx} \{x\} = \frac{d}{dx} (\sqrt[3]{x})^3.$$

We already know by Theorem 3.3.6 that

$$\frac{d}{dx} \{x\} = 1$$

and that, by Lemma 4.1.12 with $n = 3$ and $f(x) = \sqrt[3]{x}$,

$$\frac{d}{dx} (\sqrt[3]{x})^3 = 3 (\sqrt[3]{x})^2 \cdot \frac{d}{dx} \{\sqrt[3]{x}\} = 3x^{2/3} \cdot \frac{d}{dx} \{\sqrt[3]{x}\}.$$

Since we know that $\frac{d}{dx} \{x\} = \frac{d}{dx} (\sqrt[3]{x})^3$, we must have

$$1 = 3x^{2/3} \cdot \frac{d}{dx} \{\sqrt[3]{x}\}$$

which we can rearrange to give the result we need

$$\frac{d}{dx} \{\sqrt[3]{x}\} = \frac{1}{3}x^{-2/3}.$$

Example 4.1.18

Example 4.1.19

In this example, we'll use the same trickery as in Example 4.1.18 to find the derivative $x^{p/q}$ for any two natural numbers p and q . By definition of the q^{th} root,

$$x^p = (x^{p/q})^q.$$

That is, x^p and $(x^{p/q})^q$ are the same function, and so have the same derivative. So we differentiate both of them. We already know that, by Lemma 4.1.14 with $n = p$,

$$\frac{d}{dx}\{x^p\} = px^{p-1}$$

and that, by Lemma 4.1.12 with $n = q$ and $f(x) = x^{p/q}$,

$$\frac{d}{dx}\{(x^{p/q})^q\} = q(x^{p/q})^{q-1} \frac{d}{dx}\{x^{p/q}\}.$$

Remember that $(x^a)^b = x^{(a \cdot b)}$. Now these two derivatives must be the same. So

$$px^{p-1} = q \cdot x^{(pq-p)/q} \frac{d}{dx}\{x^{p/q}\}$$

and, rearranging things,

$$\begin{aligned} \frac{d}{dx}\{x^{p/q}\} &= \frac{p}{q} x^{p-1-(pq-p)/q} \\ &= \frac{p}{q} x^{(pq-q-pq+p)/q} \\ &= \frac{p}{q} x^{p/q-1}. \end{aligned}$$

So finally

$$\frac{d}{dx}\{x^{p/q}\} = \frac{p}{q} x^{p/q-1}. \tag{4.1.2}$$

Notice that this has the same form as Lemma 4.1.14, above, except with $n = p/q$ allowed to be any positive rational number, not just a positive integer.

Example 4.1.19

Example 4.1.20 (Derivative of x^{-m})

In this example we'll use the quotient rule to find the derivative of x^{-m} , for any natural number m .

By the special case of the quotient rule

$$\frac{d}{dx}\{x^{-m}\} = \frac{d}{dx}\left\{\frac{1}{x^m}\right\} = -\frac{mx^{m-1}}{(x^m)^2} = -mx^{-m-1}$$

Again, notice that this has the same form as Lemma 4.1.14, above, except with $n = -m$ being a negative integer.

Example 4.1.20

Example 4.1.21

In this example we'll use the quotient rule to find the derivative of $x^{-p/q}$, for any pair of natural numbers p and q . By a special case the quotient rule with $g(x) = x^{p/q}$ and $g'(x) = \frac{p}{q}x^{p/q-1}$,

$$\frac{d}{dx}\{x^{-p/q}\} = \frac{d}{dx}\left\{\frac{1}{x^{p/q}}\right\} = -\frac{\frac{p}{q}x^{p/q-1}}{(x^{p/q})^2} = -\frac{p}{q}x^{-p/q-1}$$

Example 4.1.21

Note that we have found, in Examples 3.3.4, 4.1.19 and 4.1.21, the derivative of x^a for any rational number a , whether 0, positive, negative, integer or fractional. In all cases, the answer is

Corollary 4.1.22 (Derivative of x^a).

Let a be a rational number, then

$$\frac{d}{dx}x^a = ax^{a-1} \quad (4.1.3)$$

We shall show, in Example 4.4.5, that the formula $\frac{d}{dx}x^a = ax^{a-1}$ in fact applies for all real numbers a , not just rational numbers.

Back in Example 3.3.14 we computed the derivative of \sqrt{x} from the definition of the derivative. The above corollary (correctly) gives

$$\frac{d}{dx}x^{1/2} = \frac{1}{2}x^{-1/2}$$

but with far less work.

Here's an (optional) messy example.

Example 4.1.23 (Optional messy example)

Find the derivative of

$$f(x) = \frac{(\sqrt{x}-1)(2-x)(1-x^2)}{\sqrt{x}(3+2x)}.$$

- As we seen before, the best strategy for dealing with nasty expressions is to break them up into easy pieces. We can think of $f(x)$ as the five-fold product

$$f(x) = f_1(x) \cdot f_2(x) \cdot f_3(x) \cdot \frac{1}{f_4(x)} \cdot \frac{1}{f_5(x)}$$

with

$$f_1(x) = \sqrt{x}-1 \quad f_2(x) = 2-x \quad f_3(x) = 1-x^2 \quad f_4(x) = \sqrt{x} \quad f_5(x) = 3+2x.$$

- By now, the derivatives of the f_j 's should be easy to find:

$$f_1'(x) = \frac{1}{2\sqrt{x}} \quad f_2'(x) = -1 \quad f_3'(x) = -2x \quad f_4'(x) = \frac{1}{2\sqrt{x}} \quad f_5'(x) = 2.$$

- Now, to get the derivative $f(x)$ we use the n -fold product rule which was developed in

Example 4.1.11, together with the quotient rule.

$$\begin{aligned} f'(x) &= f_1' f_2 f_3 \frac{1}{f_4} \frac{1}{f_5} + f_1 f_2' f_3 \frac{1}{f_4} \frac{1}{f_5} + f_1 f_2 f_3' \frac{1}{f_4} \frac{1}{f_5} - f_1 f_2 f_3 \frac{f_4'}{f_4^2} \frac{1}{f_5} - f_1 f_2 f_3 \frac{1}{f_4} \frac{f_5'}{f_5^2} \\ &= \left[\frac{f_1'}{f_1} + \frac{f_2'}{f_2} + \frac{f_3'}{f_3} - \frac{f_4'}{f_4} - \frac{f_5'}{f_5} \right] f_1 f_2 f_3 \frac{1}{f_4} \frac{1}{f_5} \\ &= \left[\frac{1}{2\sqrt{x}(\sqrt{x}-1)} - \frac{1}{2-x} - \frac{2x}{1-x^2} - \frac{1}{2x} - \frac{2}{3+2x} \right] \frac{(\sqrt{x}-1)(2-x)(1-x^2)}{\sqrt{x}(3+2x)}. \end{aligned}$$

The trick that we used in going from the first line to the second line, namely multiplying term number j by $\frac{f_j(x)}{f_j(x)}$ is often useful in simplifying the derivative of a product of many factors⁴.

Example 4.1.23

4.2 ▲ Trigonometric functions and their derivatives

Learning Objectives

- Review the definitions of trigonometric functions.
- Determine derivatives of trigonometric functions using the limit definition of derivative, trigonometric limits, addition formulas, and Product and Quotient Rules.
- Know the derivatives of sine, cosine, and tangent; be able to use those derivatives to find the derivatives of secant, cosecant, and cotangent.

We are now going to compute the derivatives of the various trigonometric functions, $\sin x$, $\cos x$ and so on. The computations are more involved than the others that we have done so far and will take several steps. Fortunately, the final answers will be very simple.

Observe that we only need to work out the derivatives of $\sin x$ and $\cos x$, since the other trigonometric functions are really just quotients of these two functions. Recall:

$$\tan x = \frac{\sin x}{\cos x} \quad \cot x = \frac{\cos x}{\sin x} \quad \csc x = \frac{1}{\sin x} \quad \sec x = \frac{1}{\cos x}.$$

The first steps towards computing the derivatives of $\sin x$, $\cos x$ is to find their derivatives at $x = 0$. The derivatives at general points x will follow quickly from these, using trig identities. It is important to note that we must measure angles in radians⁵, rather than degrees, in what follows. Indeed — unless explicitly stated otherwise, any number that is put into a trigonometric function is measured in radians.

4 Also take a look at “logarithmic differentiation” in Section 4.4.

5 In science, radians is the standard unit for measuring angles. While you may be more familiar with degrees, radians should be used in any computation involving calculus. Using degrees will cause errors. Thankfully it is easy to translate between these two measures since $360^\circ = 2\pi$ radians.

►► **These proofs are optional; the results are not.**

While we expect you to read and follow these proofs, we do not expect you to be able to reproduce them. You will be required to know the results, in particular Theorem 4.2.5 below.

►► **Step 1:** $\left. \frac{d}{dx} \{\sin x\} \right|_{x=0}$

By definition, the derivative of $\sin x$ evaluated at $x = 0$ is

$$\left. \frac{d}{dx} \{\sin x\} \right|_{x=0} = \lim_{h \rightarrow 0} \frac{\sin h - \sin 0}{h} = \lim_{h \rightarrow 0} \frac{\sin h}{h}.$$

We will prove this limit by use of a theorem called the squeeze theorem⁶. To get there we will first need to do some geometry. But first we will build some intuition.

The figure below contains part of a circle of radius 1. Recall that an arc of length h on such a circle subtends an angle of h **radians** at the centre of the circle. So the darkened arc in the figure has length h and the darkened vertical line in the figure has length $\sin h$. We must determine what happens to the ratio of the lengths of the darkened vertical line and darkened arc as h tends to zero.

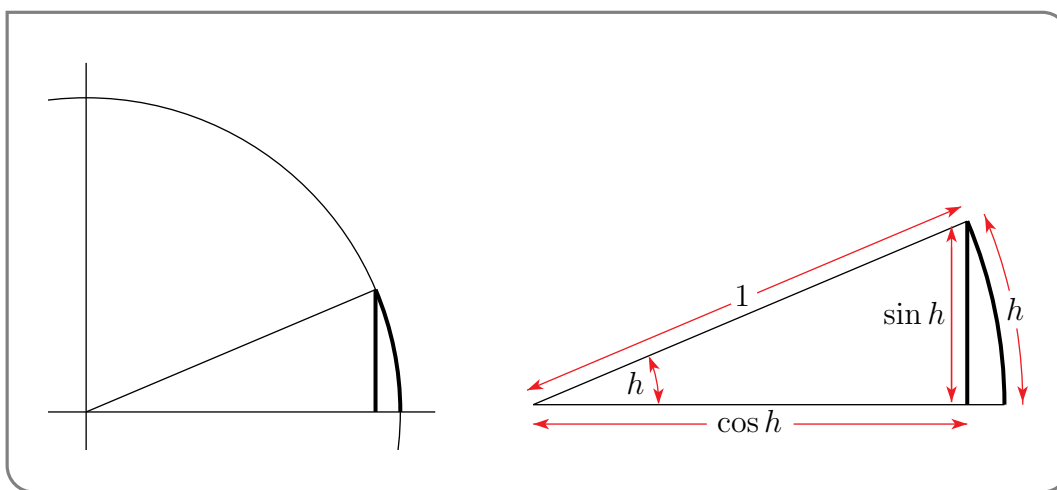

Here is a magnified version of the part of the above figure that contains the darkened arc and vertical line.

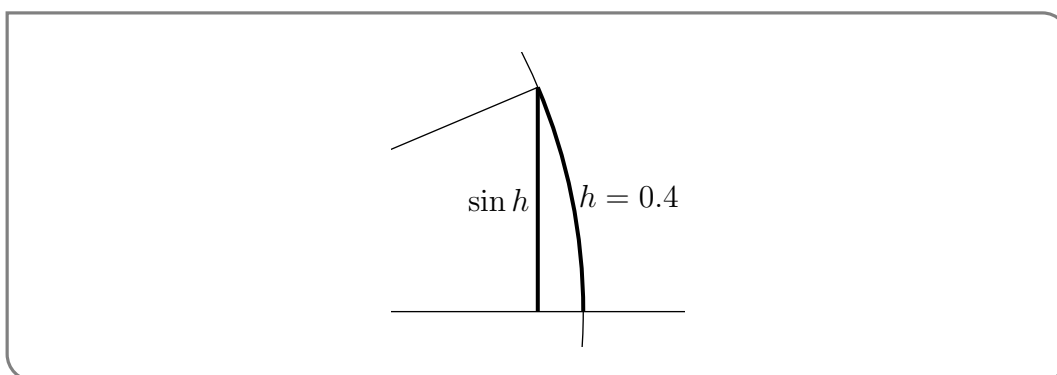

6 The squeeze theorem is not part of the Math 100 content, but we do need to use its results for this proof. This theorem tells that we can compute the limit of a function by “squeezing” or “sandwiching” it between two other functions. If the upper function and the lower function both tend to the same value, then so does the function that is squeezed between them. Formally, we would state it as: Let $a \in \mathbb{R}$ and let f, g, h be three functions so that $f(x) \leq g(x) \leq h(x)$ for all x in an interval around a , except possibly exactly at $x = a$. Then if $\lim_{x \rightarrow a} f(x) = \lim_{x \rightarrow a} h(x) = L$ then it is also the case that $\lim_{x \rightarrow a} g(x) = L$. (We do not prove it here.)

This particular figure has been drawn with $h = .4$ radians. Here are three more such blow ups. In each successive figure, the value of h is smaller. To make the figures clearer, the degree of magnification was increased each time h was decreased.

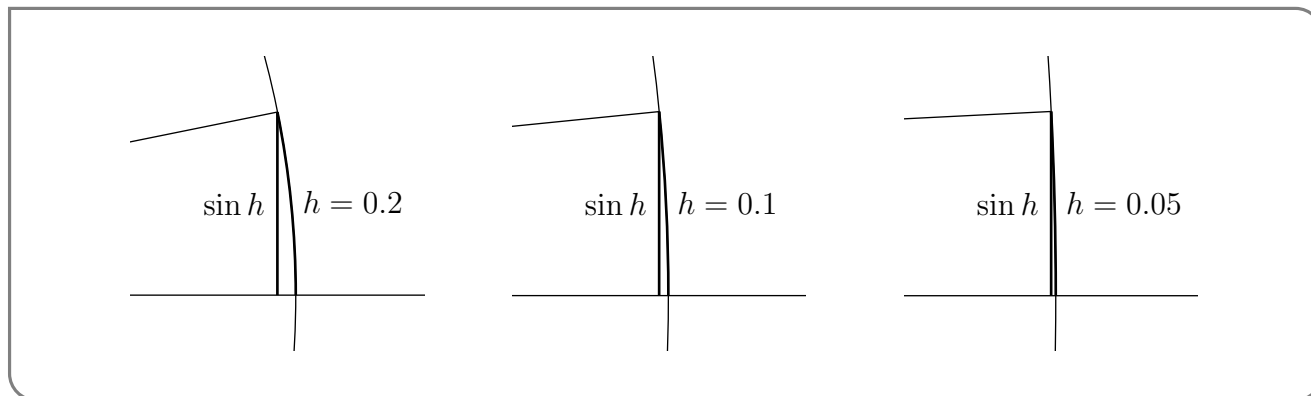

As we make h smaller and smaller and look at the figure with ever increasing magnification, the arc of length h and vertical line of length $\sin h$ look more and more alike. We would guess from this that

$$\lim_{h \rightarrow 0} \frac{\sin h}{h} = 1.$$

The following tables of values

h	$\sin h$	$\frac{\sin h}{h}$
0.4	.3894	.9735
0.2	.1987	.9934
0.1	.09983	.9983
0.05	.049979	.99958
0.01	.00999983	.999983
0.001	.0099999983	.9999983

h	$\sin h$	$\frac{\sin h}{h}$
-0.4	-.3894	.9735
-0.2	-.1987	.9934
-0.1	-.09983	.9983
-0.05	-.049979	.99958
-0.01	-.00999983	.999983
-0.001	-.0099999983	.9999983

suggests the same guess. Here is an argument that shows that the guess really is correct.

►►► **Proof that $\lim_{h \rightarrow 0} \frac{\sin h}{h} = 1$:**

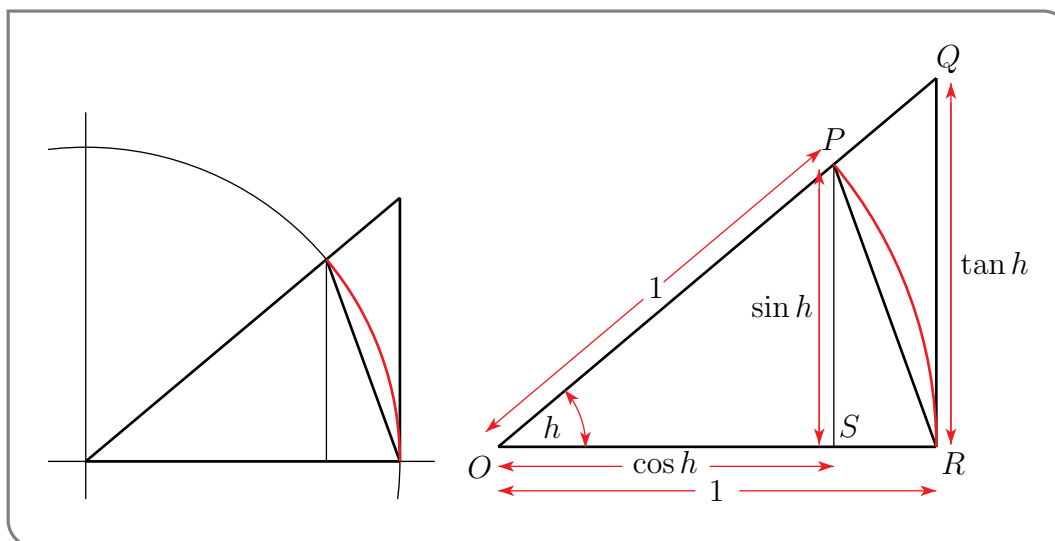

The circle in the figure above has radius 1. Hence

$$\begin{aligned} |OP| = |OR| &= 1 & |PS| &= \sin h \\ |OS| &= \cosh h & |QR| &= \tan h \end{aligned}$$

Now we can use a few geometric facts about this figure to establish both an upper bound and a lower bound on $\frac{\sinh h}{h}$ with both the upper and lower bounds tending to 1 as h tends to 0. So the squeeze theorem⁷ will tell us that $\frac{\sinh h}{h}$ also tends to 1 as h tends to 0.

- The triangle OPR has base 1 and height $\sin h$, and hence

$$\text{area of } \triangle OPR = \frac{1}{2} \times 1 \times \sin h = \frac{\sin h}{2}.$$

- The triangle OQR has base 1 and height $\tan h$, and hence

$$\text{area of } \triangle OQR = \frac{1}{2} \times 1 \times \tan h = \frac{\tan h}{2}.$$

- The “piece of pie” OPR cut out of the circle is the fraction $\frac{h}{2\pi}$ of the whole circle (since the angle at the corner of the piece of pie is h radians and the angle for the whole circle is 2π radians). Since the circle has radius 1 we have

$$\text{area of pie } OPR = \frac{h}{2\pi} \cdot (\text{area of circle}) = \frac{h}{2\pi} \pi \cdot 1^2 = \frac{h}{2}$$

Now the triangle OPR is contained inside the piece of pie OPR , and so the area of the triangle is smaller than the area of the piece of pie. Similarly, the piece of pie OPR is contained inside the triangle OQR . Thus we have

$$\text{area of triangle } OPR \leq \text{area of pie } OPR \leq \text{area of triangle } OQR$$

Substituting in the areas we worked out gives

$$\frac{\sin h}{2} \leq \frac{h}{2} \leq \frac{\tan h}{2}$$

which cleans up to give

$$\sin h \leq h \leq \frac{\sin h}{\cosh h}.$$

We rewrite these two inequalities so that $\frac{\sinh h}{h}$ appears in both.

- Since $\sin h \leq h$, we have that $\frac{\sin h}{h} \leq 1$.
- Since $h \leq \frac{\sin h}{\cosh h}$ we have that $\cosh h \leq \frac{\sin h}{h}$.

⁷ Again, we aren't proving the squeeze theorem, nor are we requiring you to know it — see the previous footnote. What you need to know here is that we are “squeezing” the function $\sin h/h$ between the upper and lower bounds.

Thus we arrive at the “squeezable” inequality:

$$\cos h \leq \frac{\sin h}{h} \leq 1.$$

We know that

$$\lim_{h \rightarrow 0} \cos h = 1.$$

Since $\frac{\sin h}{h}$ is sandwiched between $\cos h$ and 1, we deduce the following lemma:

Lemma 4.2.1.

$$\lim_{h \rightarrow 0} \frac{\sin h}{h} = 1$$

Since this argument took a bit of work, perhaps we should remind ourselves why we needed it in the first place. We were computing

$$\begin{aligned} \left. \frac{d}{dx} \{\sin x\} \right|_{x=0} &= \lim_{h \rightarrow 0} \frac{\sin h - \sin 0}{h} \\ &= \lim_{h \rightarrow 0} \frac{\sin h}{h} && \text{(This is why!)} \\ &= 1. \end{aligned}$$

This concludes Step 1. We now know that $\left. \frac{d}{dx} \sin x \right|_{x=0} = 1$. The remaining steps are easier.

► **Step 2:** $\left. \frac{d}{dx} \{\cos x\} \right|_{x=0}$

By definition, the derivative of $\cos x$ evaluated at $x = 0$ is

$$\lim_{h \rightarrow 0} \frac{\cos h - \cos 0}{h} = \lim_{h \rightarrow 0} \frac{\cos h - 1}{h}.$$

Fortunately we don’t have to wade through geometry like we did for the previous step. Instead we can recycle our work and massage the above limit to rewrite it in terms of expressions involving $\frac{\sin h}{h}$. Thanks to Lemma 4.2.1 the work is then easy.

We’ll show you two ways to proceed — one uses a method similar to “multiplying by the conjugate” that we have already used a few times (see Example 3.3.14), while the other uses a nice trick involving the double-angle formula.

▶▶▶ **Method 1 — Multiply by the “Conjugate”**

Start by multiplying the expression inside the limit by 1, written as $\frac{\cos h + 1}{\cos h + 1}$:

$$\begin{aligned}\frac{\cos h - 1}{h} &= \frac{\cos h - 1}{h} \cdot \frac{\cos h + 1}{\cos h + 1} \\ &= \frac{\cos^2 h - 1}{h(1 + \cos h)} && \text{(since } (a - b)(a + b) = a^2 - b^2 \text{)} \\ &= -\frac{\sin^2 h}{h(1 + \cos h)} && \text{(since } \sin^2 h + \cos^2 h = 1 \text{)} \\ &= -\frac{\sin h}{h} \cdot \frac{\sin h}{1 + \cos h}.\end{aligned}$$

Now we can take the limit as $h \rightarrow 0$ via Lemma 4.2.1:

$$\begin{aligned}\lim_{h \rightarrow 0} \frac{\cos h - 1}{h} &= \lim_{h \rightarrow 0} \left(\frac{-\sin h}{h} \cdot \frac{\sin h}{1 + \cos h} \right) \\ &= -\lim_{h \rightarrow 0} \left(\frac{\sin h}{h} \right) \cdot \lim_{h \rightarrow 0} \left(\frac{\sin h}{1 + \cos h} \right) \\ &= -1 \cdot \frac{0}{2} \\ &= 0.\end{aligned}$$

▶▶▶ **Method 2 — via the Double Angle Formula**

The other way involves the double angle formula,

$$\cos 2\theta = 1 - 2\sin^2(\theta) \quad \text{or} \quad \cos 2\theta - 1 = -2\sin^2(\theta).$$

Setting $\theta = h/2$, we have

$$\frac{\cos h - 1}{h} = \frac{-2(\sin \frac{h}{2})^2}{h}.$$

Now this begins to look like $\frac{\sin h}{h}$, except that inside the $\sin(\cdot)$ we have $h/2$. So, setting $\theta = h/2$,

$$\begin{aligned}\frac{\cos h - 1}{h} &= -\frac{\sin^2 \theta}{\theta} = -\theta \cdot \frac{\sin^2 \theta}{\theta^2} \\ &= -\theta \cdot \frac{\sin \theta}{\theta} \cdot \frac{\sin \theta}{\theta}.\end{aligned}$$

When we take the limit as $h \rightarrow 0$, we are also taking the limit as $\theta = h/2 \rightarrow 0$, and so

$$\begin{aligned}\lim_{h \rightarrow 0} \frac{\cos h - 1}{h} &= \lim_{\theta \rightarrow 0} \left[-\theta \cdot \frac{\sin \theta}{\theta} \cdot \frac{\sin \theta}{\theta} \right] \\ &= \lim_{\theta \rightarrow 0} [-\theta] \cdot \lim_{\theta \rightarrow 0} \left[\frac{\sin \theta}{\theta} \right] \cdot \lim_{\theta \rightarrow 0} \left[\frac{\sin \theta}{\theta} \right] \\ &= 0 \cdot 1 \cdot 1 \\ &= 0,\end{aligned}$$

where we have used the fact that $\lim_{h \rightarrow 0} \frac{\sin h}{h} = 1$ and that the limit of a product is the product of limits (i.e. Lemma 4.2.1 and Theorem 2.1.15).

Thus we have now produced two proofs of the following lemma:

Lemma 4.2.2.

$$\lim_{h \rightarrow 0} \frac{\cos h - 1}{h} = 0$$

Again, there has been a bit of work to get to here, so we should remind ourselves why we needed it. We were computing

$$\begin{aligned} \left. \frac{d}{dx} \{\cos x\} \right|_{x=0} &= \lim_{h \rightarrow 0} \frac{\cos h - \cos 0}{h} \\ &= \lim_{h \rightarrow 0} \frac{\cos h - 1}{h} \\ &= 0. \end{aligned}$$

Armed with these results we can now build up the derivatives of sine and cosine.

►► **Step 3: $\frac{d}{dx}\{\sin x\}$ and $\frac{d}{dx}\{\cos x\}$ for General x**

To proceed to the general derivatives of $\sin x$ and $\cos x$ we are going to use the above two results and a couple of trig identities. Remember the addition formulae

$$\begin{aligned} \sin(a+b) &= \sin(a)\cos(b) + \cos(a)\sin(b), \\ \cos(a+b) &= \cos(a)\cos(b) - \sin(a)\sin(b). \end{aligned}$$

To compute the derivative of $\sin(x)$ we just start from the definition of the derivative:

$$\begin{aligned} \frac{d}{dx} \sin x &= \lim_{h \rightarrow 0} \frac{\sin(x+h) - \sin x}{h} \\ &= \lim_{h \rightarrow 0} \frac{\sin x \cos h + \cos x \sin h - \sin x}{h} \\ &= \lim_{h \rightarrow 0} \left[\sin x \frac{\cos h - 1}{h} + \cos x \frac{\sin h - 0}{h} \right] \\ &= \sin x \lim_{h \rightarrow 0} \frac{\cos h - 1}{h} + \cos x \lim_{h \rightarrow 0} \frac{\sin h - 0}{h} \\ &= \sin x \underbrace{\left[\frac{d}{dx} \cos x \right]_{x=0}}_{=0} + \cos x \underbrace{\left[\frac{d}{dx} \sin x \right]_{x=0}}_{=1} \\ &= \cos x. \end{aligned}$$

The computation of the derivative of $\cos x$ is very similar.

$$\begin{aligned}
 \frac{d}{dx} \cos x &= \lim_{h \rightarrow 0} \frac{\cos(x+h) - \cos x}{h} \\
 &= \lim_{h \rightarrow 0} \frac{\cos x \cos h - \sin x \sin h - \cos x}{h} \\
 &= \lim_{h \rightarrow 0} \left[\cos x \frac{\cos h - 1}{h} - \sin x \frac{\sin h - 0}{h} \right] \\
 &= \cos x \lim_{h \rightarrow 0} \frac{\cos h - 1}{h} - \sin x \lim_{h \rightarrow 0} \frac{\sin h - 0}{h} \\
 &= \cos x \underbrace{\left[\frac{d}{dx} \cos x \right]_{x=0}}_{=0} - \sin x \underbrace{\left[\frac{d}{dx} \sin x \right]_{x=0}}_{=1} \\
 &= -\sin x.
 \end{aligned}$$

We have now found the derivatives of both $\sin x$ and $\cos x$, *provided x is measured in radians*.

Lemma 4.2.3.

$$\frac{d}{dx} \sin x = \cos x \qquad \frac{d}{dx} \cos x = -\sin x$$

The above formulas hold provided x is measured in radians.

These formulae are pretty easy to remember — applying $\frac{d}{dx}$ to $\sin x$ and $\cos x$ just exchanges $\sin x$ and $\cos x$, except for the minus sign⁸ in the derivative of $\cos x$.

Remark 4.2.4 (Optional — Another derivation of $\frac{d}{dx} \cos x = -\sin x$). We remark that, once one knows that $\frac{d}{dx} \sin x = \cos x$, it is easy to use it and the trig identity $\cos(x) = \sin\left(\frac{\pi}{2} - x\right)$ to derive $\frac{d}{dx} \cos x = -\sin x$. Here is how⁹.

$$\begin{aligned}
 \frac{d}{dx} \cos x &= \lim_{h \rightarrow 0} \frac{\cos(x+h) - \cos x}{h} = \lim_{h \rightarrow 0} \frac{\sin\left(\frac{\pi}{2} - x - h\right) - \sin\left(\frac{\pi}{2} - x\right)}{h} \\
 &= -\lim_{h' \rightarrow 0} \frac{\sin(x' + h') - \sin(x')}{h'} \qquad \text{with } x' = \frac{\pi}{2} - x, h' = -h \\
 &= -\frac{d}{dx'} \sin x' \Big|_{x' = \frac{\pi}{2} - x} = -\cos\left(\frac{\pi}{2} - x\right) \\
 &= -\sin x.
 \end{aligned}$$

Note that, if x is measured in degrees, then the formulas of Lemma 4.2.3 are wrong. There are similar formulas, but we need the chain rule to build them — that is the subject of the next section. But first we should find the derivatives of the other trig functions.

8 There is a bad pun somewhere in here about sine errors and sign errors.

9 We thank Serban Raianu for suggesting that we include this.

►► Step 4: The remaining trigonometric functions

It is now an easy matter to get the derivatives of the remaining trigonometric functions using basic trig identities and the quotient rule. Remember that

$$\begin{aligned}\tan x &= \frac{\sin x}{\cos x} & \cot x &= \frac{\cos x}{\sin x} = \frac{1}{\tan x} \\ \csc x &= \frac{1}{\sin x} & \sec x &= \frac{1}{\cos x}\end{aligned}$$

So, by the quotient rule,

$$\begin{aligned}\frac{d}{dx} \tan x &= \frac{d}{dx} \frac{\sin x}{\cos x} = \frac{\overbrace{\left(\frac{d}{dx} \sin x\right)}^{\cos x} \cos x - \sin x \overbrace{\left(\frac{d}{dx} \cos x\right)}^{-\sin x}}{\cos^2 x} = \sec^2 x \\ \frac{d}{dx} \csc x &= \frac{d}{dx} \frac{1}{\sin x} = -\frac{\overbrace{\left(\frac{d}{dx} \sin x\right)}^{\cos x}}{\sin^2 x} = -\csc x \cot x \\ \frac{d}{dx} \sec x &= \frac{d}{dx} \frac{1}{\cos x} = -\frac{\overbrace{\left(\frac{d}{dx} \cos x\right)}^{-\sin x}}{\cos^2 x} = \sec x \tan x \\ \frac{d}{dx} \cot x &= \frac{d}{dx} \frac{\cos x}{\sin x} = \frac{\overbrace{\left(\frac{d}{dx} \cos x\right)}^{-\sin x} \sin x - \cos x \overbrace{\left(\frac{d}{dx} \sin x\right)}^{\cos x}}{\sin^2 x} = -\csc^2 x.\end{aligned}$$

►► Summary

To summarise all this work, we can write this up as a theorem:

Theorem 4.2.5 (Derivatives of trigonometric functions).

The derivatives of $\sin x$ and $\cos x$ are

$$\frac{d}{dx} \sin x = \cos x \qquad \frac{d}{dx} \cos x = -\sin x$$

Consequently the derivatives of the other trigonometric functions are

$$\begin{aligned}\frac{d}{dx} \tan x &= \sec^2 x & \frac{d}{dx} \cot x &= -\csc^2 x \\ \frac{d}{dx} \csc x &= -\csc x \cot x & \frac{d}{dx} \sec x &= \sec x \tan x\end{aligned}$$

Of these 6 derivatives you should really memorise those of sine, cosine and tangent. We certainly expect you to be able to work out those of cotangent, cosecant and secant.

4.3 ▲ The chain rule

Learning Objectives

- Use the chain rule to compute derivatives of compositions of functions.

We have built up most of the tools that we need to express derivatives of complicated functions in terms of derivatives of simpler known functions. We started by learning how to evaluate

- derivatives of sums, products and quotients,
- derivatives of constants and monomials.

These tools allow us to compute derivatives of polynomials and rational functions. We have also added exponential and trigonometric functions to our list. The final tool we add is called the chain rule. It tells us how to take the derivative of a composition of two functions. That is if we know $f(x)$ and $g(x)$ and their derivatives, then the chain rule tells us the derivative of $f(g(x))$.

Before we get to the statement of the rule, let us look at an example showing how such a composition might arise (in the “real-world”).

Example 4.3.1

You are out in the woods after a long day of mathematics and are walking towards your camp fire on a beautiful still night. The heat from the fire means that the air temperature depends on your position. Let your position at time t be $x(t)$. The temperature of the air at position x is $f(x)$. What instantaneous rate of change of temperature do you feel at time t ?

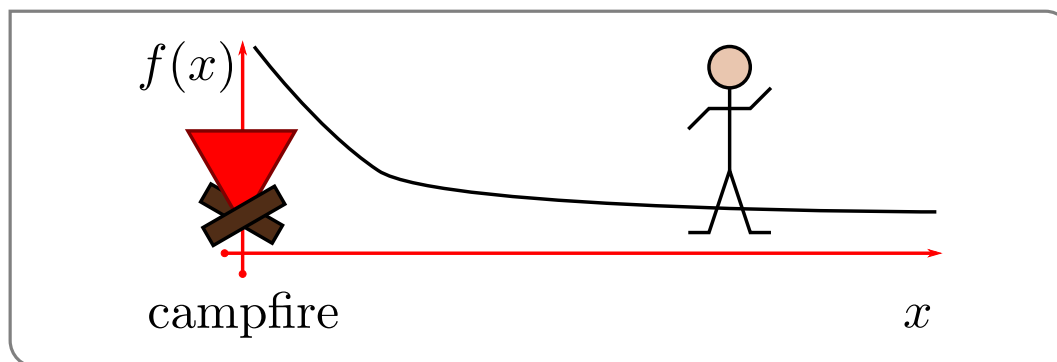

- Because your position at time t is $x = x(t)$, the temperature you feel at time t is $F(t) = f(x(t))$.
- The instantaneous rate of change of temperature that you feel is $F'(t)$. We have a complicated function, $F(t)$, constructed by composing two simpler functions, $x(t)$ and $f(x)$.
- We wish to compute the derivative, $F'(t) = \frac{d}{dt}f(x(t))$, of the complicated function $F(t)$ in terms of the derivatives, $x'(t)$ and $f'(x)$, of the two simple functions. This is exactly what the chain rule does.

Example 4.3.1

►► Statement of the chain rule

Theorem 4.3.2 (The chain rule — version 1).

Let $a \in \mathbb{R}$ and let $g(x)$ be a function that is differentiable at $x = a$. Now let $f(u)$ be a function that is differentiable at $u = g(a)$. Then the function $F(x) = f(g(x))$ is differentiable at $x = a$ and

$$F'(a) = f'(g(a)) g'(a)$$

Here, as was the case earlier in this chapter, we have been very careful to give the point at which the derivative is evaluated a special name (i.e. a). But of course this evaluation point can really be any point (where the derivative is defined). So it is very common to just call the evaluation point “ x ” rather than give it a special name like “ a ”, like this:

Theorem 4.3.3 (The chain rule — version 2).

Let f and g be differentiable functions then

$$\frac{d}{dx} f(g(x)) = f'(g(x)) \cdot g'(x)$$

Notice that when we form the composition $f(g(x))$ there is an “outside” function (namely $f(x)$) and an “inside” function (namely $g(x)$). The chain rule tells us that when we differentiate a composition that we have to differentiate the outside and then multiply by the derivative of the inside.

$$\frac{d}{dx} f(g(x)) = \underbrace{f'(g(x))}_{\text{diff outside}} \cdot \underbrace{g'(x)}_{\text{diff inside}}$$

Here is another statement of the chain rule which makes this idea more explicit.

Theorem 4.3.4 (The chain rule — version 3).

Let $y = f(u)$ and $u = g(x)$ be differentiable functions, then

$$\frac{dy}{dx} = \frac{dy}{du} \cdot \frac{du}{dx}$$

This particular form is easy to remember because it looks like we can just “cancel” the du between the two terms.

$$\frac{dy}{dx} = \frac{dy}{\cancel{du}} \cdot \frac{\cancel{du}}{dx}$$

Of course, du is not, by itself, a number or variable¹⁰ that can be cancelled. But this is still a good memory aid.

The hardest part about applying the chain rule is recognising when the function you are trying to differentiate is really the composition of two simpler functions. This takes a little practice. We can warm up with a couple of simple examples.

Example 4.3.5

Let $f(u) = u^5$ and $g(x) = \sin(x)$. Then set $F(x) = f(g(x)) = (\sin(x))^5$. To find the derivative of $F(x)$ we can simply apply the chain rule — the pieces of the composition have been laid out for us. Here they are:

$$\begin{array}{ll} f(u) = u^5 & f'(u) = 5u^4 \\ g(x) = \sin(x) & g'(x) = \cos x. \end{array}$$

We now just put them together as the chain rule tells us:

$$\begin{aligned} \frac{dF}{dx} &= f'(g(x)) \cdot g'(x) \\ &= 5(g(x))^4 \cdot \cos(x) && \text{since } f'(u) = 5u^4 \\ &= 5(\sin(x))^4 \cdot \cos(x). \end{aligned}$$

Notice that it is quite easy to extend this to any power. Set $f(u) = u^n$. Then follow the same steps and we arrive at

$$F(x) = (\sin(x))^n, \quad F'(x) = n(\sin(x))^{n-1} \cos(x).$$

Example 4.3.5

This example shows one of the ways that the chain rule appears very frequently — when we need to differentiate the power of some simpler function. More generally we have the following.

Example 4.3.6

Let $f(u) = u^n$ and let $g(x)$ be any differentiable function. Set $F(x) = f(g(x)) = g(x)^n$. Then

$$\frac{dF}{dx} = \frac{d}{dx}(g(x)^n) = ng(x)^{n-1} \cdot g'(x)$$

This is precisely the result in Example 4.1.11 and Lemma 4.1.12.

Example 4.3.6

Example 4.3.7

Let $f(u) = \cos(u)$ and $g(x) = 3x - 2$. Find the derivative of

$$F(x) = f(g(x)) = \cos(3x - 2).$$

10 In this context du is called a differential. There are ways to understand and manipulate these in calculus but they are beyond the scope of this course.

Again we should approach this by first writing down f and g and their derivatives and then putting everything together as the chain rule tells us.

$$\begin{aligned} f(u) &= \cos(u) & f'(u) &= -\sin(u) \\ g(x) &= 3x - 2 & g'(x) &= 3. \end{aligned}$$

So the chain rule says

$$\begin{aligned} F'(x) &= f'(g(x)) \cdot g'(x) \\ &= -\sin(g(x)) \cdot 3 \\ &= -3 \sin(3x - 2). \end{aligned}$$

Example 4.3.7

This example shows a second way that the chain rule appears very frequently — when we need to differentiate some function of $ax + b$. More generally we have the following.

Example 4.3.8

Let $a, b \in \mathbb{R}$ and let $f(x)$ be a differentiable function. Set $g(x) = ax + b$. Then

$$\begin{aligned} \frac{d}{dx} f(ax + b) &= \frac{d}{dx} f(g(x)) \\ &= f'(g(x)) \cdot g'(x) \\ &= f'(ax + b) \cdot a. \end{aligned}$$

So the derivative of $f(ax + b)$ with respect to x is just $af'(ax + b)$.

Example 4.3.8

The above is a very useful result that follows from the chain rule, so let's make it a corollary to highlight it.

Corollary 4.3.9.

Let $a, b \in \mathbb{R}$ and let $f(x)$ be a differentiable function, then

$$\frac{d}{dx} f(ax + b) = af'(ax + b).$$

Example 4.3.10 (Example 4.3.1, continued)

Let us now go back to our motivating campfire example. There we had

$$\begin{aligned} f(x) &= \text{temperature at position } x, \\ x(t) &= \text{position at time } t, \\ F(t) &= f(x(t)) = \text{temperature at time } t. \end{aligned}$$

The chain rule gave

$$F'(t) = f'(x(t)) \cdot x'(t).$$

Notice that the units of measurement on both sides of the equation agree — as indeed they must. To see this, let us assume that t is measured in seconds, that $x(t)$ is measured in metres and that $f(x)$ is measured in degrees. Because of this $F(x(t))$ must also be measured in degrees (since it is a temperature).

What about the derivatives? These are rates of change. So

- $F'(t)$ has units $\frac{\text{degrees}}{\text{second}}$,
- $f'(x)$ has units $\frac{\text{degrees}}{\text{metre}}$, and
- $x'(t)$ has units $\frac{\text{metre}}{\text{second}}$

Hence the product

$$f'(x(t)) \cdot x'(t) \text{ has units } = \frac{\text{degrees}}{\text{metre}} \cdot \frac{\text{metre}}{\text{second}} = \frac{\text{degrees}}{\text{second}}.$$

has the same units as $F'(t)$. So the units on both sides of the equation agree. Checking that the units on both sides of an equation agree is a good check of consistency, but of course it does not prove that both sides are in fact the same.

Example 4.3.10

►► (optional) — Derivation of the chain rule

First, let's review what our goal is. We have been given a function $g(x)$, that is differentiable at some point $x = a$, and another function $f(u)$, that is differentiable at the point $u = b = g(a)$. We have defined the composite function $F(x) = f(g(x))$ and we wish to show that

$$F'(a) = f'(g(a)) \cdot g'(a).$$

Before we can compute $F'(a)$, we need to set up some ground work, and in particular the definitions of our given derivatives:

$$f'(b) = \lim_{H \rightarrow 0} \frac{f(b+H) - f(b)}{H} \quad \text{and} \quad g'(a) = \lim_{h \rightarrow 0} \frac{g(a+h) - g(a)}{h}.$$

We are going to use similar manipulation tricks as we did back in the proofs of the arithmetic of derivatives in Section 4.1. Unfortunately, we have already used up the symbols “ F ” and “ H ”, so we are going to make use the Greek letters γ, φ .

As was the case in our derivation of the product rule it is convenient to introduce a couple of new functions. Set

$$\varphi(H) = \frac{f(b+H) - f(b)}{H}.$$

Then we have

$$\lim_{H \rightarrow 0} \varphi(H) = f'(b) = f'(g(a)) \quad \text{since } b = g(a), \quad (4.3.1)$$

and we can also write (with a little juggling)

$$f(b+H) = f(b) + H\varphi(H).$$

Similarly set

$$\gamma(h) = \frac{g(a+h) - g(a)}{h}$$

which gives us

$$\lim_{h \rightarrow 0} \gamma(h) = g'(a) \quad \text{and} \quad g(a+h) = g(a) + h\gamma(h).$$

Now we can start computing

$$\begin{aligned} F'(a) &= \lim_{h \rightarrow 0} \frac{F(a+h) - F(a)}{h} \\ &= \lim_{h \rightarrow 0} \frac{f(g(a+h)) - f(g(a))}{h}. \end{aligned}$$

We know that $g(a) = b$ and $g(a+h) = g(a) + h\gamma(h)$, so

$$\begin{aligned} F'(a) &= \lim_{h \rightarrow 0} \frac{f(g(a) + h\gamma(h)) - f(g(a))}{h} \\ &= \lim_{h \rightarrow 0} \frac{f(b + h\gamma(h)) - f(b)}{h}. \end{aligned}$$

Now for the sneaky bit. We can turn $f(b + h\gamma(h))$ into $f(b + H)$ by setting

$$H = h\gamma(h).$$

Now notice that as $h \rightarrow 0$ we have

$$\begin{aligned} \lim_{h \rightarrow 0} H &= \lim_{h \rightarrow 0} h \cdot \gamma(h) \\ &= \lim_{h \rightarrow 0} h \cdot \lim_{h \rightarrow 0} \gamma(h) \\ &= 0 \cdot g'(a) = 0. \end{aligned}$$

So as $h \rightarrow 0$ we also have $H \rightarrow 0$.

We now have

$$\begin{aligned} F'(a) &= \lim_{h \rightarrow 0} \frac{f(b+H) - f(b)}{h} \\ &= \lim_{h \rightarrow 0} \underbrace{\frac{f(b+H) - f(b)}{H}}_{=\varphi(H)} \cdot \underbrace{\frac{H}{h}}_{=\gamma(h)} \quad \text{if } H = h\gamma(h) \neq 0 \\ &= \lim_{h \rightarrow 0} (\varphi(H) \cdot \gamma(h)) \\ &= \lim_{h \rightarrow 0} \varphi(H) \cdot \lim_{h \rightarrow 0} \gamma(h) \quad \text{since } H \rightarrow 0 \text{ as } h \rightarrow 0 \\ &= \lim_{H \rightarrow 0} \varphi(H) \cdot \lim_{h \rightarrow 0} \gamma(h) \quad = f'(b) \cdot g'(a) \end{aligned}$$

This is exactly the RHS of the chain rule. It is possible to have $H = 0$ in the second line above. But that possibility is easy to deal with:

- If $g'(a) \neq 0$, then, since $\lim_{h \rightarrow 0} \gamma(h) = g'(a)$, $H = h\gamma(h)$ cannot be 0 for small nonzero h . Technically, there is an $h_0 > 0$ such that $H = h\gamma(h) \neq 0$ for all $0 < |h| < h_0$. In taking the limit $h \rightarrow 0$, above, we need only consider $0 < |h| < h_0$ and so, in this case, the above computation is completely correct.
- If $g'(a) = 0$, the above computation is still fine provided we exclude all h 's for which $H = h\gamma(h) \neq 0$. When $g'(a) = 0$, the right hand side, $f'(g(a)) \cdot g'(a)$, of the chain rule is 0. So the above computation gives

$$\lim_{\substack{h \rightarrow 0 \\ \gamma(h) \neq 0}} \frac{f(b+H) - f(b)}{h} = f'(g(a)) \cdot g'(a) = 0.$$

On the other hand, when $H = 0$, we have $f(b+H) - f(b) = 0$. So

$$\lim_{\substack{h \rightarrow 0 \\ \gamma(h) = 0}} \frac{f(b+H) - f(b)}{h} = 0$$

too. That's all we need.

►► Chain rule examples

We'll now use the chain rule to compute some more derivatives.

Example 4.3.11

Find $\frac{d}{dx}(1+3x)^{75}$.

This is a concrete version of Example 4.3.8. We are to find the derivative of a function that is built up by first computing $1+3x$ and then taking the 75th power of the result. So we set

$$\begin{aligned} f(u) &= u^{75} & f'(u) &= 75u^{74} \\ g(x) &= 1+3x & g'(x) &= 3 \\ F(x) &= f(g(x)) = g(x)^{75} = (1+3x)^{75}. \end{aligned}$$

By the chain rule,

$$\begin{aligned} F'(x) &= f'(g(x))g'(x) = 75g(x)^{74}g'(x) = 75(1+3x)^{74} \cdot 3 \\ &= 225(1+3x)^{74}. \end{aligned}$$

Example 4.3.11

Example 4.3.12

Find $\frac{d}{dx} \sin(x^2)$.

In this example we are to compute the derivative of \sin with a (slightly) complicated argument. So we apply the chain rule with f being \sin and $g(x)$ being the complicated argument. That is, we set

$$\begin{aligned} f(u) &= \sin u & f'(u) &= \cos u \\ g(x) &= x^2 & g'(x) &= 2x \\ F(x) &= f(g(x)) = \sin(g(x)) = \sin(x^2). \end{aligned}$$

By the chain rule,

$$\begin{aligned} F'(x) &= f'(g(x)) g'(x) = \cos(g(x)) g'(x) = \cos(x^2) \cdot 2x \\ &= 2x \cos(x^2). \end{aligned}$$

Example 4.3.12

Example 4.3.13

Find $\frac{d}{dx} \sqrt[3]{\sin(x^2)}$.

In this example we are to compute the derivative of the cube root of a (moderately) complicated argument, namely $\sin(x^2)$. So we apply the chain rule with f being “cube root” and $g(x)$ being the complicated argument. That is, we set

$$\begin{aligned} f(u) &= \sqrt[3]{u} = u^{\frac{1}{3}} & f'(u) &= \frac{1}{3} u^{-\frac{2}{3}} \\ g(x) &= \sin(x^2) & g'(x) &= 2x \cos(x^2) \\ F(x) &= f(g(x)) = \sqrt[3]{g(x)} = \sqrt[3]{\sin(x^2)}. \end{aligned}$$

In computing $g'(x)$ here, we have already used the chain rule once (in Example 4.3.12). By the chain rule,

$$\begin{aligned} F'(x) &= f'(g(x)) g'(x) = \frac{1}{3} g(x)^{-\frac{2}{3}} \cdot 2x \cos(x^2) \\ &= \frac{2x}{3} \frac{\cos(x^2)}{[\sin(x^2)]^{\frac{2}{3}}}. \end{aligned}$$

Example 4.3.13

Example 4.3.14

Find the derivative of $\frac{d}{dx} f(g(h(x)))$.

This is very similar to the previous example. Let us set $F(x) = f(g(h(x)))$ with $u = g(h(x))$. Then the chain rule tells us that

$$\begin{aligned} \frac{dF}{dx} &= \frac{df}{du} \cdot \frac{du}{dx} \\ &= f'(g(h(x))) \cdot \frac{d}{dx} g(h(x)). \end{aligned}$$

We now just apply the chain rule again

$$= f'(g(h(x))) \cdot g'(h(x)) \cdot h'(x).$$

Indeed it is not too hard to generalise further (in the manner of Example 4.1.11 to find the derivative of the composition of 4 or more functions (though things start to become tedious to write down):

$$\begin{aligned} \frac{d}{dx} f_1(f_2(f_3(f_4(x)))) &= f_1'(f_2(f_3(f_4(x)))) \cdot \frac{d}{dx} f_2(f_3(f_4(x))) \\ &= f_1'(f_2(f_3(f_4(x)))) \cdot f_2'(f_3(f_4(x))) \cdot \frac{d}{dx} f_3(f_4(x)) \\ &= f_1'(f_2(f_3(f_4(x)))) \cdot f_2'(f_3(f_4(x))) \cdot f_3'(f_4(x)) \cdot f_4'(x). \end{aligned}$$

↑ Example 4.3.14 ↑

↓ Example 4.3.15 ↓

We can also use the chain rule to calculate the derivative of the reciprocal of a function¹¹, and from there we can use the product rule to recover the quotient rule.

We want to differentiate $F(x) = \frac{1}{g(x)}$ so set $f(u) = \frac{1}{u}$ and $u = g(x)$. Then the chain rule tells us

$$\begin{aligned} \frac{d}{dx} \left\{ \frac{1}{g(x)} \right\} &= \frac{dF}{dx} = \frac{df}{du} \cdot \frac{du}{dx} \\ &= \frac{-1}{u^2} \cdot g'(x) \\ &= -\frac{g'(x)}{g(x)^2}. \end{aligned}$$

Once we know this, a quick application of the product rule will give us the quotient rule.

$$\begin{aligned} \frac{d}{dx} \left\{ \frac{f(x)}{g(x)} \right\} &= \frac{d}{dx} \left\{ f(x) \cdot \frac{1}{g(x)} \right\} && \text{use PR} \\ &= f'(x) \cdot \frac{1}{g(x)} + f(x) \cdot \frac{d}{dx} \left\{ \frac{1}{g(x)} \right\} && \text{use the result from above} \\ &= f'(x) \cdot \frac{1}{g(x)} - f(x) \cdot \frac{g'(x)}{g(x)^2} && \text{place over a common denominator} \\ &= \frac{f'(x) \cdot g(x) - f(x) \cdot g'(x)}{g(x)^2} \end{aligned}$$

↑ which is exactly the quotient rule. Example 4.3.15 ↑

11 We glimpsed this case earlier, in Example 4.1.9.

Example 4.3.16

Compute the following derivative:

$$\frac{d}{dx} \cos \left(\frac{x^5 \sqrt{3+x^6}}{(4+x^2)^3} \right)$$

This time we are to compute the derivative of \cos with a really complicated argument.

- So, to start, we apply the chain rule with $g(x) = \frac{x^5 \sqrt{3+x^6}}{(4+x^2)^3}$ being the really complicated argument and f being \cos . That is, $f(u) = \cos(u)$. Since $f'(u) = -\sin(u)$, the chain rule gives

$$\frac{d}{dx} \cos \left(\frac{x^5 \sqrt{3+x^6}}{(4+x^2)^3} \right) = -\sin \left(\frac{x^5 \sqrt{3+x^6}}{(4+x^2)^3} \right) \frac{d}{dx} \left\{ \frac{x^5 \sqrt{3+x^6}}{(4+x^2)^3} \right\}.$$

- This reduced our problem to that of computing the derivative of the really complicated argument $\frac{x^5 \sqrt{3+x^6}}{(4+x^2)^3}$. We can think of the argument as being built up out of three pieces, namely x^5 , multiplied by $\sqrt{3+x^6}$, divided by $(4+x^2)^3$, or, equivalently, multiplied by $(4+x^2)^{-3}$. So we may rewrite $\frac{x^5 \sqrt{3+x^6}}{(4+x^2)^3}$ as $x^5 (3+x^6)^{1/2} (4+x^2)^{-3}$, and then apply the product rule to reduce the problem to that of computing the derivatives of the three pieces.
- Here goes (recall Example 4.1.11):

$$\begin{aligned} \frac{d}{dx} [x^5 (3+x^6)^{1/2} (4+x^2)^{-3}] &= \frac{d}{dx} [x^5] \cdot (3+x^6)^{1/2} \cdot (4+x^2)^{-3} \\ &\quad + x^5 \cdot \frac{d}{dx} [(3+x^6)^{1/2}] \cdot (4+x^2)^{-3} \\ &\quad + x^5 \cdot (3+x^6)^{1/2} \cdot \frac{d}{dx} [(4+x^2)^{-3}]. \end{aligned}$$

This has reduced our problem to computing the derivatives of x^5 , which is easy, and of $(3+x^6)^{1/2}$ and $(4+x^2)^{-3}$, both of which can be done by the chain rule. Doing so,

$$\begin{aligned} \frac{d}{dx} [x^5 (3+x^6)^{1/2} (4+x^2)^{-3}] &= \overbrace{\frac{d}{dx} [x^5]}^{5x^4} \cdot (3+x^6)^{1/2} \cdot (4+x^2)^{-3} \\ &\quad + x^5 \cdot \overbrace{\frac{d}{dx} [(3+x^6)^{1/2}]}^{\frac{1}{2}(3+x^6)^{-1/2} \cdot 6x^5} \cdot (4+x^2)^{-3} \\ &\quad + x^5 \cdot (3+x^6)^{1/2} \cdot \overbrace{\frac{d}{dx} [(4+x^2)^{-3}]}^{-3(4+x^2)^{-4} \cdot 2x}. \end{aligned}$$

- Now we can clean things up in a sneaky way by observing
 - differentiating x^5 , to get $5x^4$, is the same as multiplying x^5 by $\frac{5}{x}$, and

- differentiating $(3 + x^6)^{\frac{1}{2}}$ to get $\frac{1}{2}(3 + x^6)^{-1/2} \cdot 6x^5$ is the same as multiplying $(3 + x^6)^{\frac{1}{2}}$ by $\frac{3x^5}{3+x^6}$, and
- differentiating $(4 + x^2)^{-3}$ to get $-3(4 + x^2)^{-4} \cdot 2x$ is the same as multiplying $(4 + x^2)^{-3}$ by $-\frac{6x}{4+x^2}$.

Using these sneaky tricks we can write our solution quite neatly:

$$\frac{d}{dx} \cos \left(\frac{x^5 \sqrt{3+x^6}}{(4+x^2)^3} \right) = -\sin \left(\frac{x^5 \sqrt{3+x^6}}{(4+x^2)^3} \right) \frac{x^5 \sqrt{3+x^6}}{(4+x^2)^3} \left\{ \frac{5}{x} + \frac{3x^5}{3+x^6} - \frac{6x}{4+x^2} \right\}.$$

- This method of cleaning up the derivative of a messy product is actually something more systematic in disguise — namely logarithmic differentiation. This is our next topic.

Example 4.3.16

4.4 ▲ Logarithmic differentiation

Learning Objectives

- Differentiate logarithmic functions.
- Determine when to use logarithmic differentiation to simplify derivatives.
- Use logarithmic differentiation.
- Use the generalized product rule to compute the derivative of products of many functions.

The chain rule opens the way to understanding derivatives of more complicated function. Not only compositions of known functions as we have seen the examples of the previous section, but also functions which are defined implicitly.

Consider the logarithm base e — $\log_e(x)$ is the power that e must be raised to to give x . That is, $\log_e(x)$ is defined by

$$e^{\log_e x} = x$$

i.e. — it is the inverse of the exponential function with base e . Since this choice of base works so cleanly and easily with respect to differentiation, this base turns out to be (arguably) the most natural choice for the base of the logarithm. And as we saw in our whirlwind review of logarithms in Section 3.5, it is easy to use logarithms of one base to compute logarithms with another base:

$$\log_q x = \frac{\log_e x}{\log_e q}$$

So we are (relatively) free to choose a base which is convenient for our purposes.

The logarithm with base e , is called the “natural logarithm”. The “naturalness” of logarithms base e is exactly that this choice of base works very nicely in calculus (and so wider mathematics) in ways that other bases do not¹². There are several different “standard” notations for the logarithm base e ;

$$\log_e x = \log x = \ln x.$$

We recommend that you be able to recognise all of these.

In this text we will write the natural logarithm as “log” with no base. The reason for this choice is that base e is the standard choice of base for logarithms in mathematics¹³. The natural logarithm inherits many properties of general logarithms¹⁴. So, for all $x, y > 0$ the following hold:

- $e^{\log x} = x$,
- for any real number X , $\log(e^X) = X$,
- for any $a > 1$, $\log_a x = \frac{\log x}{\log a}$ and $\log x = \frac{\log_a x}{\log_a e}$
- $\log 1 = 0$, $\log e = 1$
- $\log(xy) = \log x + \log y$
- $\log\left(\frac{x}{y}\right) = \log x - \log y$, $\log\left(\frac{1}{y}\right) = -\log y$
- $\log(x^X) = X \log x$
- $\lim_{x \rightarrow \infty} \log x = \infty$, $\lim_{x \rightarrow 0} \log x = -\infty$

And finally we should remember that $\log x$ has domain (i.e. is defined for) $x > 0$ and range (i.e. takes all values in) $-\infty < x < \infty$.

Figure 4.4.1.

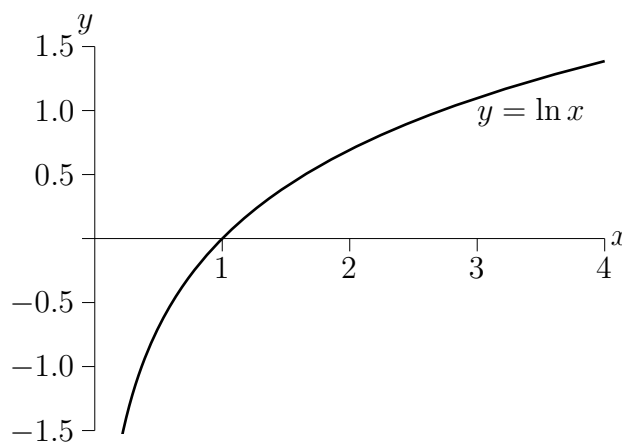

12 The interested reader should head to Wikipedia and look up the natural logarithm.

13 In other disciplines other bases are natural; in computer science, since numbers are stored in binary it makes sense to use the binary logarithm — i.e. base 2. While in some sciences and finance, it makes sense to use the decimal logarithm — i.e. base 10.

14 Again take a quick look at the whirlwind review of logarithms in Section 3.5.

To compute the derivative of $\log x$ we could attempt to start with the limit definition of the derivative

$$\begin{aligned}\frac{d}{dx} \log x &= \lim_{h \rightarrow 0} \frac{\log(x+h) - \log(x)}{h} \\ &= \lim_{h \rightarrow 0} \frac{\log((x+h)/x)}{h} \\ &= \text{um...}\end{aligned}$$

This doesn't look good. But all is not lost — we have the chain rule, and we know that the logarithm satisfies the equation:

$$x = e^{\log x}$$

Since both sides of the equation are the same function, both sides of the equation have the same derivative. i.e. we are using¹⁵

$$\text{if } f(x) = g(x) \text{ for all } x, \text{ then } f'(x) = g'(x)$$

So now differentiate both sides:

$$\frac{d}{dx} x = \frac{d}{dx} e^{\log x}$$

The left-hand side is easy, and the right-hand side we can process using the chain rule with $f(u) = e^u$ and $u = \log x$.

$$\begin{aligned}1 &= \frac{df}{du} \cdot \frac{du}{dx} \\ &= e^u \cdot \underbrace{\frac{d}{dx} \log x}_{\text{what we want to compute}}\end{aligned}$$

Recall that $e^u = e^{\log x} = x$, so

$$1 = x \cdot \underbrace{\frac{d}{dx} \log x}_{\text{now what?}}$$

We can now just rearrange this equation to make the thing we want the subject:

$$\frac{d}{dx} \log x = \frac{1}{x}$$

Thus we have proved:

Theorem 4.4.1.

$$\frac{d}{dx} \log x = \frac{1}{x}$$

where $\log x$ is the logarithm base e .

15 Notice that just because the derivatives are the same, doesn't mean the original functions are the same. Both $f(x) = x^2$ and $g(x) = x^2 + 3$ have derivative $f'(x) = g'(x) = 2x$, but $f(x) \neq g(x)$.

Example 4.4.2

Let $f(x) = \log 3x$. Find $f'(x)$.

There are two ways to approach this — we can simplify then differentiate, or differentiate and then simplify. Neither is difficult.

- Simplify and then differentiate:

$$\begin{aligned} f(x) &= \log 3x && \text{log of a product} \\ &= \log 3 + \log x \\ f'(x) &= \frac{d}{dx} \log 3 + \frac{d}{dx} \log x \\ &= \frac{1}{x}. \end{aligned}$$

- Differentiation and then simplify:

$$\begin{aligned} f'(x) &= \frac{d}{dx} \log(3x) && \text{chain rule} \\ &= \frac{1}{3x} \cdot 3 \\ &= \frac{1}{x} \end{aligned}$$

Example 4.4.2

Example 4.4.3 (The derivative of $\log cx$)

Notice that we can extend the previous example for any positive constant — not just 3. Let $c > 0$ be a constant, then

$$\begin{aligned} \frac{d}{dx} \log cx &= \frac{d}{dx} (\log c + \log x) \\ &= \frac{1}{x} \end{aligned}$$

Example 4.4.3

Example 4.4.4 (The derivative of $\log |x|$)

We can push this further still. Let $g(x) = \log |x|$, then¹⁶

- If $x > 0$, $|x| = x$ and so

$$g'(x) = \frac{d}{dx} \log x = \frac{1}{x}$$

¹⁶ It's probably a good moment to go back and look at Example 3.3.15.

- If $x < 0$ then $|x| = -x$. If $|h|$ is strictly smaller than $|x|$, then we also have that $x + h < 0$ and $|x + h| = -(x + h) = |x| - h$. Write $X = |x|$ and $H = -h$. Then, by the definition of the derivative,

$$\begin{aligned} g'(x) &= \lim_{h \rightarrow 0} \frac{\log|x+h| - \log|x|}{h} = \lim_{h \rightarrow 0} \frac{\log(|x| - h) - \log|x|}{h} \\ &= \lim_{H \rightarrow 0} \frac{\log(X+H) - \log X}{-H} = - \lim_{H \rightarrow 0} \frac{\log(X+H) - \log X}{H} \\ &= - \frac{d}{dX} \log X = - \frac{1}{X} = - \frac{1}{|x|} \\ &= \frac{1}{x} \end{aligned}$$

- Since $\log 0$ is undefined, $g'(0)$ does not exist.

Putting this together gives:

$$\frac{d}{dx} \log|x| = \frac{1}{x}$$

Example 4.4.4

Example 4.4.5 (The derivative of x^a)

Just after Corollary 4.1.22, we said that we would, in the future, find the derivative of x^a for all real numbers. The future is here. Let $x > 0$ and a be any real number. Exponentiating both sides of $\log(x^a) = a \log x$ gives us $x^a = e^{a \log x}$ and then

$$\begin{aligned} \frac{d}{dx} x^a &= \frac{d}{dx} e^{a \log x} = e^{a \log x} \frac{d}{dx} (a \log x) && \text{by the chain rule} \\ &= \frac{a}{x} e^{a \log x} = \frac{a}{x} x^a \\ &= a x^{a-1} \end{aligned}$$

as expected.

Example 4.4.5

We can extend Theorem 4.4.1 to compute the derivative of logarithms of other bases in a straightforward way. Since for any positive $a \neq 1$:

$$\begin{aligned} \log_a x &= \frac{\log x}{\log a} = \frac{1}{\log a} \cdot \log x && \text{since } a \text{ is a constant} \\ \frac{d}{dx} \log_a x &= \frac{1}{\log a} \cdot \frac{1}{x} \end{aligned}$$

►► **Back to** $\frac{d}{dx}a^x$

We can also now finally get around to computing the derivative of a^x (which we started to do back in Section 3.5).

Example 4.4.6 (The derivative of a^x)

We show two ways to compute this derivative.

- Method 1:

$$\begin{array}{ll} f(x) = a^x & \text{take log of both sides} \\ \log f(x) = x \log a & \text{exponentiate both sides base } e \\ f(x) = e^{x \log a} & \text{chain rule} \\ f'(x) = e^{x \log a} \cdot \log a & \\ = a^x \cdot \log a. & \end{array}$$

- Method 2:

$$\begin{array}{ll} f(x) = a^x & \text{take log of both sides} \\ \log f(x) = x \log a & \text{differentiate both sides} \\ \frac{d}{dx}(\log f(x)) = \log a & \end{array}$$

We then process the left-hand side using the chain rule

$$\begin{array}{l} f'(x) \cdot \frac{1}{f(x)} = \log a \\ f'(x) = f(x) \cdot \log a = a^x \cdot \log a. \end{array}$$

Example 4.4.6

We will see $\frac{d}{dx} \log f(x)$ more below in the subsection on “logarithmic differentiation”.

To summarise the results above:

Corollary 4.4.7.

$$\begin{array}{ll} \frac{d}{dx} a^x = \log a \cdot a^x & \text{for any } a > 0 \\ \frac{d}{dx} \log_a x = \frac{1}{x \cdot \log a} & \text{for any } a > 0, a \neq 1 \end{array}$$

where $\log x$ is the natural logarithm.

Recall that we need the caveat $a \neq 1$ because the logarithm base 1 is not well defined. This is because $1^x = 1$ for any x . We do not need a similar caveat for the derivative of the exponential because we know (recall Example 3.5.1)

$$\begin{array}{ll} \frac{d}{dx} 1^x = \frac{d}{dx} 1 = 0 & \text{while the above corollary tells us} \\ = \log 1 \cdot 1^x = 0 \cdot 1 = 0. & \end{array}$$

►► Revisiting examples, this time through logarithmic differentiation

We want to go back to some previous slightly messy examples (Examples 4.1.11 and 4.1.23) and now show you how they can be done more easily.

Example 4.4.8

Consider again the derivative of the product of 3 functions:

$$P(x) = F(x) \cdot G(x) \cdot H(x)$$

Start by taking the logarithm of both sides:

$$\begin{aligned} \log P(x) &= \log(F(x) \cdot G(x) \cdot H(x)) \\ &= \log F(x) + \log G(x) + \log H(x). \end{aligned}$$

Notice that the product of functions on the right-hand side has become a sum of functions. Differentiating sums is much easier than differentiating products. So when we differentiate we have

$$\frac{d}{dx} \log P(x) = \frac{d}{dx} \log F(x) + \frac{d}{dx} \log G(x) + \frac{d}{dx} \log H(x).$$

A quick application of the chain rule shows that $\frac{d}{dx} \log f(x) = f'(x)/f(x)$:

$$\frac{P'(x)}{P(x)} = \frac{F'(x)}{F(x)} + \frac{G'(x)}{G(x)} + \frac{H'(x)}{H(x)}.$$

Multiply through by $P(x) = F(x)G(x)H(x)$:

$$\begin{aligned} P'(x) &= \left(\frac{F'(x)}{F(x)} + \frac{G'(x)}{G(x)} + \frac{H'(x)}{H(x)} \right) \cdot F(x)G(x)H(x) \\ &= F'(x)G(x)H(x) + F(x)G'(x)H(x) + F(x)G(x)H'(x). \end{aligned}$$

which is what found in Example 4.1.11 by repeated application of the product rule. The above generalises quite easily to more than 3 functions.

Example 4.4.8

This same trick of “take a logarithm and then differentiate” — or logarithmic differentiation — will work any time you have a product (or ratio) of functions.

Example 4.4.9

Let’s use logarithmic differentiation on the function from Example 4.1.23:

$$f(x) = \frac{(\sqrt{x}-1)(2-x)(1-x^2)}{\sqrt{x}(3+2x)}$$

Beware however, that we may only take the logarithm of positive numbers, and this $f(x)$ is often negative. For example, if $1 < x < 2$, the factor $(1-x^2)$ in the definition of $f(x)$ is negative while all of the other factors are positive, so that $f(x) < 0$. None-the-less, we can use logarithmic

differentiation to find $f'(x)$, by exploiting the observation that $\frac{d}{dx} \log |f(x)| = \frac{f'(x)}{f(x)}$. (To see this, use the chain rule and Example 4.4.4.) So we take the logarithm of $|f(x)|$ and expand.

$$\begin{aligned} \log |f(x)| &= \log \frac{|\sqrt{x}-1||2-x||1-x^2|}{\sqrt{x}|3+2x|} \\ &= \log |\sqrt{x}-1| + \log |2-x| + \log |1-x^2| - \underbrace{\log(\sqrt{x})}_{=\frac{1}{2} \log x} - \log |3+2x| \end{aligned}$$

Now we can essentially just differentiate term-by-term:

$$\begin{aligned} \frac{d}{dx} \log |f(x)| &= \frac{d}{dx} \left(\log |\sqrt{x}-1| + \log |2-x| + \log |1-x^2| - \frac{1}{2} \log(x) - \log |3+2x| \right) \\ \frac{f'(x)}{f(x)} &= \frac{1/(2\sqrt{x})}{\sqrt{x}-1} + \frac{-1}{2-x} + \frac{-2x}{1-x^2} - \frac{1}{2x} - \frac{2}{3+2x} \\ f'(x) &= f(x) \cdot \left(\frac{1}{2\sqrt{x}(\sqrt{x}-1)} - \frac{1}{2-x} - \frac{2x}{1-x^2} - \frac{1}{2x} - \frac{2}{3+2x} \right) \\ &= \frac{(\sqrt{x}-1)(2-x)(1-x^2)}{\sqrt{x}(3+2x)} \cdot \left(\frac{1}{2\sqrt{x}(\sqrt{x}-1)} - \frac{1}{2-x} - \frac{2x}{1-x^2} - \frac{1}{2x} - \frac{2}{3+2x} \right) \end{aligned}$$

just as we found previously.

Example 4.4.9

4.5 ▴ Implicit differentiation

Learning Objectives

- Explain how implicit differentiation is a consequence of the Chain Rule.
- Use implicit differentiation to find slopes of tangent lines to implicitly defined curves.

Implicit differentiation is a simple trick that is used to compute derivatives of functions either

- when you don't know an explicit formula for the function, but you know an equation that the function obeys, or
- even when you have an explicit, but complicated, formula for the function, and the function obeys a simple equation.

The trick is just to differentiate both sides of the equation and then solve for the derivative we are seeking. In fact we have already done this, without using the name “implicit differentiation”, when we found the derivative of $\log x$ in the previous section. There we knew that the function

$f(x) = \log x$ satisfied the equation $e^{f(x)} = x$ for all x . That is, the functions $e^{f(x)}$ and x are in fact the same function and so have the same derivative. So we had

$$\frac{d}{dx} e^{f(x)} = \frac{d}{dx} x = 1$$

We then used the chain rule to get $\frac{d}{dx} e^{f(x)} = e^{f(x)} f'(x)$, which told us that $f'(x)$ obeys the equation

$$e^{f(x)} f'(x) = 1 \quad \text{and we can now solve for } f'(x)$$

$$f'(x) = e^{-f(x)} = e^{-\log x} = \frac{1}{x}.$$

The typical way to get used to implicit differentiation is to play with problems involving tangent lines to curves. So here are a few examples finding the equations of tangent lines to curves. Recall, from Theorem 3.3.7¹⁷, that, in general, the tangent line to the curve $y = f(x)$ at (x_0, y_0) is $y = f(x_0) + f'(x_0)(x - x_0) = y_0 + f'(x_0)(x - x_0)$.

Example 4.5.1

Find the equation of the tangent line to $y = y^3 + xy + x^3$ at $x = 1$.

This is a very standard sounding example, but made a little complicated by the fact that the curve is given by a cubic equation — which means we cannot solve directly for y in terms of x or vice versa. So we really do need implicit differentiation.

- First notice that when $x = 1$ the equation, $y = y^3 + xy + x^3$, of the curve simplifies to $y = y^3 + y + 1$ or $y^3 = -1$, which we can solve¹⁸: $y = -1$. So we know that the curve passes through $(1, -1)$ when $x = 1$.
- Now, to find the slope of the tangent line at $(1, -1)$, pretend that our curve is $y = f(x)$ so that $f(x)$ obeys

$$f(x) = f(x)^3 + xf(x) + x^3$$

for all x . Differentiating both sides gives

$$f'(x) = 3f(x)^2 f'(x) + f(x) + xf'(x) + 3x^2$$

- At this point we could isolate for $f'(x)$ and write it in terms of $f(x)$ and x , but since we only want answers when $x = 1$, let us substitute in $x = 1$ and $f(1) = -1$ (since the curve passes through $(1, -1)$) and clean things up before doing anything else.
- Subbing in $x = 1$, $f(1) = -1$ gives

$$f'(1) = 3f'(1) - 1 + f'(1) + 3 \quad \text{and so } f'(1) = -\frac{2}{3}$$

17 In Theorem 3.3.7 we wrote the x -coordinate of the point as a . The following examples use the name x_0 instead. Of course, we could use any name we would like — $a, x_0, \heartsuit, \dots$ etc — but the symbols that are usually chosen for this are x_0 or a .

18 This type of luck rarely happens in the “real world”. But it happens remarkably frequently in textbooks, problem sets and tests.

- The equation of the tangent line is

$$y = y_0 + f'(x_0)(x - x_0) = -1 - \frac{2}{3}(x - 1) = -\frac{2}{3}x - \frac{1}{3}$$

We can further clean up the equation of the line to write it as $2x + 3y = -1$.

Example 4.5.1

In the previous example we replace y by $f(x)$ in the middle of the computation. We don't actually have to do this. When we are writing out our solution we can remember that y is a function of x . So we can start with

$$y = y^3 + xy + x^3$$

and differentiate remembering that $y \equiv y(x)$

$$y' = 3y^2y' + xy' + y + 3x^2$$

And now substitute $x = 1, y = -1$ to get

$$\begin{aligned} y'(1) &= 3 \cdot y'(1) + y'(1) - 1 + 3 && \text{and so} \\ y'(1) &= -\frac{2}{3} \end{aligned}$$

As a brief interlude to the tangent line problems: note that implicit differentiation can be used for higher-order derivatives, too. Consider the same function as in the above example, and the problem of finding its second derivative.

Example 4.5.2 (Example 4.5.1, continued)

Find y'' if $y = y^3 + xy + x^3$.

Solution. Again, this problem concerns some function $y(x)$ that is not given to us explicitly. All that we are told is that $y(x)$ satisfies

$$y(x) = y(x)^3 + xy(x) + x^3 \tag{E1}$$

for all x . We are asked to find $y''(x)$. We cannot solve this equation to get an explicit formula for $y(x)$. So we use implicit differentiation, as we did in Example 4.5.1. That is, we apply $\frac{d}{dx}$ to both sides of (E1). This gives

$$y'(x) = 3y(x)^2y'(x) + y(x) + xy'(x) + 3x^2 \tag{E2}$$

Since Example 4.5.1 asked us to find the tangent line at a specific point, we substituted in some values before solving for $y'(x)$. In this example we are just finding the general derivative – not at a specific value – so there are no values to substitute in. We go directly to solving for $y'(x)$ by moving all $y'(x)$'s to the left hand side, giving

$$[1 - x - 3y(x)^2]y'(x) = y(x) + 3x^2$$

and then dividing across to get

$$y'(x) = \frac{y(x) + 3x^2}{1 - x - 3y(x)^2}. \tag{E3}$$

To get $y''(x)$ from here, we have two options.

Method 1. Apply $\frac{d}{dx}$ to both sides of (E2). This gives

$$y''(x) = 3y(x)^2 y''(x) + 6y(x)y'(x)^2 + 2y'(x) + xy''(x) + 6x$$

We can now solve for $y''(x)$, giving

$$y''(x) = \frac{6x + 2y'(x) + 6y(x)y'(x)^2}{1 - x - 3y(x)^2} \quad (\text{E4})$$

Then we can substitute in (E3), giving

$$\begin{aligned} y''(x) &= 2 \frac{3x + \frac{y(x)+3x^2}{1-x-3y(x)^2} + 3y(x) \left(\frac{y(x)+3x^2}{1-x-3y(x)^2} \right)^2}{1 - x - 3y(x)^2} \\ &= 2 \frac{3x[1 - x - 3y(x)^2]^2 + [y(x) + 3x^2][1 - x - 3y(x)^2] + 3y(x)[y(x) + 3x^2]^2}{[1 - x - 3y(x)^2]^3} \end{aligned}$$

Method 2. Alternatively, we can also differentiate (E3).

$$\begin{aligned} y''(x) &= \frac{[y'(x) + 6x][1 - x - 3y(x)^2] - [y(x) + 3x^2][-1 - 6y(x)y'(x)]}{[1 - x - 3y(x)^2]^2} \\ &= \frac{\left[\frac{y(x)+3x^2}{1-x-3y(x)^2} + 6x \right][1 - x - 3y(x)^2] - [y(x) + 3x^2] \left[-1 - 6y(x) \frac{y(x)+3x^2}{1-x-3y(x)^2} \right]}{[1 - x - 3y(x)^2]^2} \\ &= \frac{2[y(x) + 3x^2][1 - x - 3y(x)^2] + 6x[1 - x - 3y(x)^2]^2 + 6y(x)[y(x) + 3x^2]^2}{[1 - x - 3y(x)^2]^3} \end{aligned}$$

Remark 1. We have now computed $y''(x)$ — sort of. The answer is in terms of $y(x)$, which we don't know. Since we cannot get an explicit formula for $y(x)$, there's not a great deal that we can do, in general.

Remark 2. Even though we cannot solve $y = y^3 + xy + x^3$ explicitly for $y(x)$, for general x , it is sometimes possible to solve equations like this for some special values of x . In fact, we saw in Example 4.5.1 that when $x = 1$, the given equation reduces to $y(1) = y(1)^3 + 1 \cdot y(1) + 1^3$, or $y(1)^3 = -1$, which we can solve to get $y(1) = -1$. Substituting into (E2), as we did in Example 4.5.1 gives

$$y'(1) = \frac{-1 + 3}{1 - 1 - 3(-1)^2} = -\frac{2}{3}$$

and substituting into (E4) gives

$$y''(1) = \frac{6 + 2\left(-\frac{2}{3}\right) + 6(-1)\left(-\frac{2}{3}\right)^2}{1 - 1 - 3(-1)^2} = \frac{6 - \frac{4}{3} - \frac{8}{3}}{-3} = -\frac{2}{3}$$

(It's a fluke that, in this example, $y'(1)$ and $y''(1)$ happen to be equal.) So we now know that, even though we can't solve $y = y^3 + xy + x^3$ explicitly for $y(x)$, the graph of the solution passes through $(1, -1)$ and has slope $-\frac{2}{3}$ (i.e. is sloping downwards by between 30° and 45°) there and, furthermore, the slope of the graph decreases as x increases through $x = 1$.

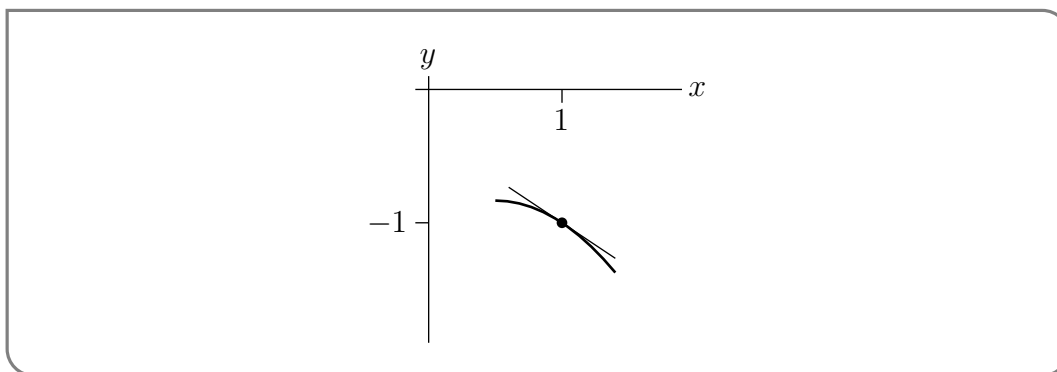

Here is a sketch of the part of the graph very near $(1, -1)$. The tangent line to the graph at $(1, -1)$ is also shown. Note that the tangent line is sloping down to the right, as we expect, and that the graph lies below the tangent line near $(1, -1)$. That's because the slope $f'(x)$ is decreasing (becoming more negative) as x passes through 1.

Example 4.5.2

Warning 4.5.3.

Many people will suppress the (x) in $y(x)$ when doing computations like those in Example 4.5.2. This gives shorter, easier to read formulae, like $y' = \frac{y+3x^2}{1-x-3y^2}$. If you do this, you must never forget that y is a function of x and is *not* a constant. If you do forget, you'll make the very serious error of saying that $\frac{dy}{dx} = 0$, which is false.

Okay. The next one returns to a question involving tangent lines, and is at the same time a bit easier (because it is a quadratic, and because we only need to take the first derivative) and a bit harder (because we are asked for the tangent at a general point on the curve, not a specific one).

Example 4.5.4

Let (x_0, y_0) be a point on the ellipse $3x^2 + 5y^2 = 7$. Find the equation for the tangent lines when $x = 1$ and y is positive. Then find an equation for the tangent line to the ellipse at a general point (x_0, y_0) .

Since we are not given an specific point x_0 we are going to have to be careful with the second half of this question.

- When $x = 1$ the equation simplifies to

$$\begin{aligned} 3 + 5y^2 &= 7 \\ 5y^2 &= 4 \\ y &= \pm \frac{2}{\sqrt{5}}. \end{aligned}$$

We are only interested in positive y , so our point on the curve is $(1, 2/\sqrt{5})$.

- Now we use implicit differentiation to find $\frac{dy}{dx}$ at this point. First we pretend that we have solved the curve explicitly, for some interval of x 's, as $y = f(x)$. The equation becomes

$$\begin{aligned} 3x^2 + 5f(x)^2 &= 7 && \text{now differentiate} \\ 6x + 10f(x)f'(x) &= 0 \\ f'(x) &= -\frac{3x}{5f(x)}. \end{aligned}$$

- When $x = 1, y = 2/\sqrt{5}$ this becomes

$$f'(1) = -\frac{3}{5 \cdot 2/\sqrt{5}} = -\frac{3}{2\sqrt{5}}.$$

So the tangent line passes through $(1, 2/\sqrt{5})$ and has slope $-\frac{3}{2\sqrt{5}}$. Hence the tangent line has equation

$$\begin{aligned} y &= y_0 + f'(x_0)(x - x_0) \\ &= \frac{2}{\sqrt{5}} - \frac{3}{2\sqrt{5}}(x - 1) \\ &= \frac{7 - 3x}{2\sqrt{5}} && \text{or equivalently} \\ 3x + 2\sqrt{5}y &= 7. \end{aligned}$$

Now we should go back and do the same but for a general point on the curve (x_0, y_0) :

- A good first step here is to sketch the curve. Since this is an ellipse, it is pretty straight-forward.

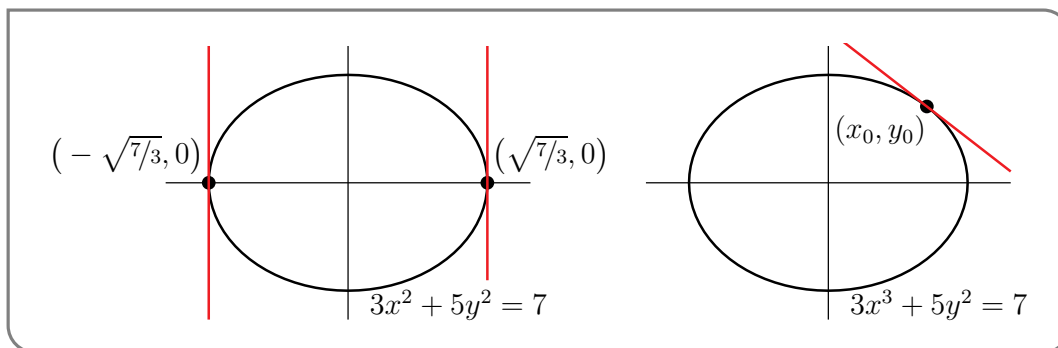

- Notice that there are two points on the ellipse — the extreme right and left points $(x_0, y_0) = \pm(\sqrt{7/3}, 0)$ — at which the tangent line is vertical. In those two cases, the tangent line is just $x = x_0$.
- Since this is a quadratic for y , we could solve it explicitly to get

$$y = \pm\sqrt{\frac{7 - 3x^2}{5}}$$

and choose the positive or negative branch as appropriate. Then we could differentiate to find the slope and put things together to get the tangent line.

But even in this relatively easy case, it is computationally cleaner, and hence less vulnerable to mechanical errors, to use implicit differentiation. So that's what we'll do.

- Now we could again “pretend” that we have solved the equation for the ellipse for $y = f(x)$ near (x_0, y_0) , but let’s not do that. Instead (as we did just before this example) just remember that when we differentiate y is really a function of x . So starting from

$$\begin{aligned} 3x^2 + 5y^2 &= 7 && \text{differentiating gives} \\ 6x + 5 \cdot 2y \cdot y' &= 0. \end{aligned}$$

We can then solve this for y' :

$$y' = -\frac{3x}{5y}$$

where y' and y are both functions of x .

- Hence at the point (x_0, y_0) we have

$$y'|_{(x_0, y_0)} = -\frac{3x_0}{5y_0}.$$

This is the slope of the tangent line at (x_0, y_0) and so its equation is

$$\begin{aligned} y &= y_0 + y' \cdot (x - x_0) \\ &= y_0 - \frac{3x_0}{5y_0}(x - x_0). \end{aligned}$$

We can simplify this by multiplying through by $5y_0$ to get

$$5y_0y = 5y_0^2 - 3x_0x + 3x_0^2.$$

We can clean this up more by moving all the terms that contain x or y to the left-hand side and everything else to the right:

$$3x_0x + 5y_0y = 3x_0^2 + 5y_0^2.$$

But there is one more thing we can do, our original equation is $3x^2 + 5y^2 = 7$ for all points on the curve, so we know that $3x_0^2 + 5y_0^2 = 7$. This cleans up the right-hand side:

$$3x_0x + 5y_0y = 7.$$

- In deriving this formula for the tangent line at (x_0, y_0) we have assumed that $y_0 \neq 0$. But in fact the final answer happens to also work when $y_0 = 0$ (which means $x_0 = \pm\sqrt{7/3}$), so that the tangent line is $x = x_0$.

We can also check that our answer for general (x_0, y_0) reduces to our answer for $x_0 = 1$.

- When $x_0 = 1$ we worked out that $y_0 = 2/\sqrt{5}$.
- Plugging this into our answer above gives

$$\begin{aligned} 3x_0x + 5y_0y &= 7 && \text{sub in } (x_0, y_0) = (1, 2/\sqrt{5}) : \\ 3x + 5 \frac{2}{\sqrt{5}}y &= 7 && \text{clean up a little} \\ 3x + 2\sqrt{5}y &= 7 \end{aligned}$$

as required.

Example 4.5.4

Example 4.5.5

At which points does the curve $x^2 - xy + y^2 = 3$ cross the x -axis? Are the tangent lines to the curve at those points parallel?

This is a 2 part question — first the x -intercepts and then we need to examine tangent lines.

- Finding where the curve crosses the x -axis is straight forward. It does so when $y = 0$. This means x satisfies

$$x^2 - x \cdot 0 + 0^2 = 3 \qquad \text{so } x = \pm\sqrt{3}.$$

So the curve crosses the x -axis at two points $(\pm\sqrt{3}, 0)$.

- Now we need to find the tangent lines at those points. But we don't actually need the lines, just their slopes. Again we can pretend that near one of those points the curve is $y = f(x)$. Applying $\frac{d}{dx}$ to both sides of $x^2 - xf(x) + f(x)^2 = 3$ gives

$$2x - f(x) - xf'(x) + 2f(x)f'(x) = 0$$

etc etc.

- But let us stop “pretending”. Just make sure we remember that y is a function of x when we differentiate:

$$\begin{aligned} x^2 - xy + y^2 &= 3 && \text{start with the curve, and differentiate} \\ 2x - xy' - y + 2yy' &= 0 \end{aligned}$$

Now substitute in the first point, $x = +\sqrt{3}, y = 0$:

$$\begin{aligned} 2\sqrt{3} - \sqrt{3}y' + 0 &= 0 \\ y' &= 2 \end{aligned}$$

And now do the second point $x = -\sqrt{3}, y = 0$:

$$\begin{aligned} -2\sqrt{3} + \sqrt{3}y' + 0 &= 0 \\ y' &= 2 \end{aligned}$$

Thus the slope is the same at $x = \sqrt{3}$ and $x = -\sqrt{3}$ and the tangent lines are parallel.

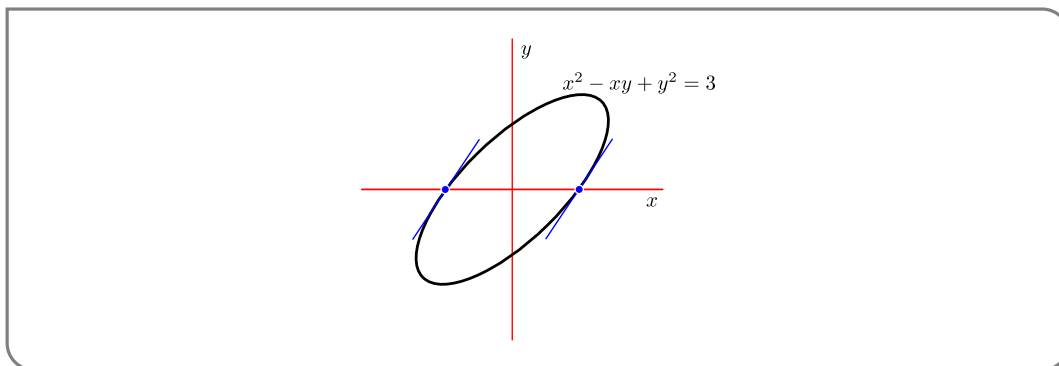

Example 4.5.5

Okay — let's get away from curves and do something a little different.

Example 4.5.6

You are standing at the origin. At time zero a pitcher throws a ball at your head¹⁹.

Figure 4.5.1.

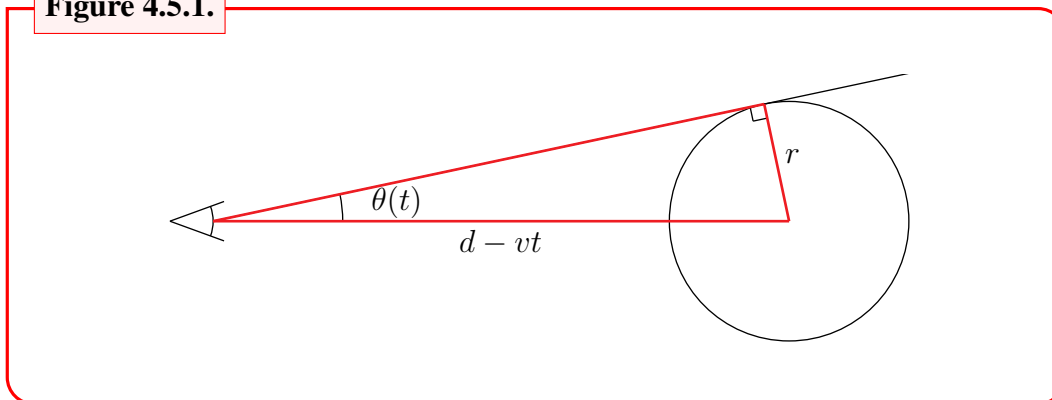

The position of the (centre of the) ball at time t is $x(t) = d - vt$, where d is the distance from your head to the pitcher's mound and v is the ball's velocity. Your eye sees the ball filling²⁰ an angle $2\theta(t)$ with

$$\sin(\theta(t)) = \frac{r}{d - vt}$$

where r is the radius of the baseball. The question is “How fast is θ growing at time t ?” That is, what is $\frac{d\theta}{dt}$?

- We don't know (yet) how to solve this equation to find $\theta(t)$ explicitly. So we use implicit differentiation.
- To do so we apply $\frac{d}{dt}$ to both sides of our equation. This gives

$$\cos(\theta(t)) \cdot \theta'(t) = \frac{rv}{(d - vt)^2}$$

- Then we solve for $\theta'(t)$:

$$\theta'(t) = \frac{rv}{(d - vt)^2 \cos(\theta(t))}$$

- As is often the case, when using implicit differentiation, this answer is not very satisfying because it contains $\theta(t)$, for which we still do not have an explicit formula. However in this case we can get an explicit formula for $\cos(\theta(t))$, without having an explicit formula for $\theta(t)$, just by looking at the right-angled triangle in Figure 4.5.1, above.

¹⁹ It seems that it is not a friendly game today.

²⁰ This is the “visual angle” or “angular size”.

- The hypotenuse of that triangle has length $d - vt$. By Pythagoras, the length of the side of the triangle adjacent of the angle $\theta(t)$ is $\sqrt{(d - vt)^2 - r^2}$. So

$$\cos(\theta(t)) = \frac{\sqrt{(d - vt)^2 - r^2}}{d - vt}$$

and

$$\theta'(t) = \frac{rv}{(d - vt)\sqrt{(d - vt)^2 - r^2}}$$

Example 4.5.6

Okay — just one more tangent-to-the-curve example and then we'll go on to something different.

Example 4.5.7

Let (x_0, y_0) be a point on the astroid²¹

$$x^{2/3} + y^{2/3} = 1.$$

Find an equation for the tangent line to the astroid at (x_0, y_0) .

- As was the case in examples above we can rewrite the equation of the astroid near (x_0, y_0) in the form $y = f(x)$, with an explicit $f(x)$, by solving the equation $x^{2/3} + y^{2/3} = 1$. But again, it is computationally cleaner, and hence less vulnerable to mechanical errors, to use implicit differentiation. So that's what we'll do.
- First up, since (x_0, y_0) lies on the curve, it satisfies

$$x_0^{2/3} + y_0^{2/3} = 1.$$

- Now, no pretending that $y = f(x)$, this time — just make sure we remember when we differentiate that y changes with x .

$$\begin{aligned} x^{2/3} + y^{2/3} &= 1 && \text{start with the curve, and differentiate} \\ \frac{2}{3}x^{-1/3} + \frac{2}{3}y^{-1/3}y' &= 0 \end{aligned}$$

- Note the derivative of $x^{2/3}$, namely $\frac{2}{3}x^{-1/3}$, and the derivative of $y^{2/3}$, namely $\frac{2}{3}y^{-1/3}y'$, are defined only when $x \neq 0$ and $y \neq 0$. We are interested in the case that $x = x_0$ and $y = y_0$. So we better assume that $x_0 \neq 0$ and $y_0 \neq 0$. Probably something weird happens when $x_0 = 0$ or $y_0 = 0$. We'll come back to this shortly.

²¹ Here is where the astroid comes from. Imagine two circles, one of radius $1/4$ and one of radius 1 . Paint a red dot on the smaller circle. Then imagine the smaller circle rolling around the inside of the larger circle. The curve traced by the red dot is our astroid. Search “astroid” (be careful about the spelling) to find animations showing this. The astroid was first discussed by Johann Bernoulli in 1691–92. It also appears in the work of Leibniz.

- To continue on, we set $x = x_0, y = y_0$ in the equation above, and then solve for y' :

$$\frac{2}{3}x_0^{-1/3} + \frac{2}{3}y_0^{-1/3}y'(x) = 0 \implies y'(x_0) = -\left(\frac{y_0}{x_0}\right)^{1/3}$$

This is the slope of the tangent line and its equation is

$$y = y_0 + f'(x_0)(x - x_0) = y_0 - \left(\frac{y_0}{x_0}\right)^{1/3} (x - x_0)$$

Now let's think a little bit about what the tangent line slope of $-\sqrt[3]{y_0/x_0}$ tells us about the astroid.

- First, as a preliminary observation, note that since $x_0^{2/3} \geq 0$ and $y_0^{2/3} \geq 0$ the equation $x_0^{2/3} + y_0^{2/3} = 1$ of the astroid forces $0 \leq x_0^{2/3}, y_0^{2/3} \leq 1$ and hence $-1 \leq x_0, y_0 \leq 1$.
- For all $x_0, y_0 > 0$ the slope $-\sqrt[3]{y_0/x_0} < 0$. So at all points on the astroid that are in the first quadrant, the tangent line has negative slope, i.e. is “leaning backwards”.
- As x_0 tends to zero, y_0 tends to ± 1 and the tangent line slope tends to infinity. So at points on the astroid near $(0, \pm 1)$, the tangent line is almost vertical.
- As y_0 tends to zero, x_0 tends to ± 1 and the tangent line slope tends to zero. So at points on the astroid near $(\pm 1, 0)$, the tangent line is almost horizontal.

Here is a figure illustrating all this.

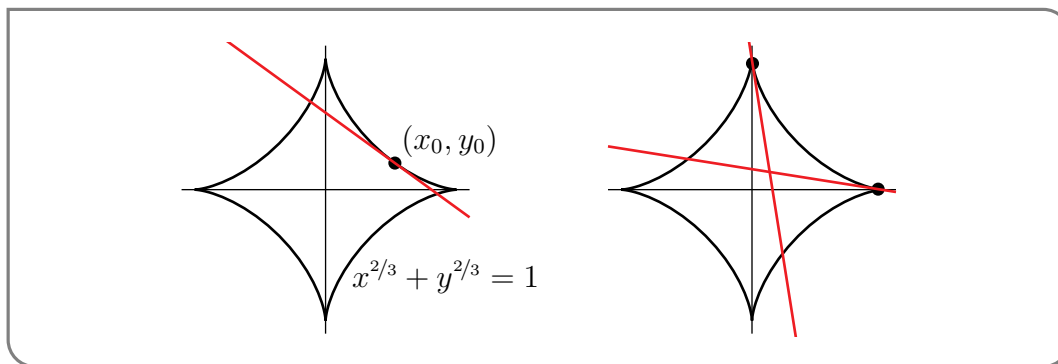

Sure enough, as we speculated earlier, something weird does happen to the astroid when x_0 or y_0 is zero. The astroid is pointy, and does not have a tangent there.

Example 4.5.7

4.6 ▲ Inverse functions

Learning Objectives

- Understand what the inverse of a function is.

One very useful application of implicit differentiation is to find the derivatives of inverse functions. We have already used this approach to find the derivative of the inverse of the exponential function — the logarithm — in §4.4.

In this section we will first describe what an inverse function is, and work through some examples, and then show how to use implicit differentiation to compute the derivative of an inverse function.

In Example 4.5.6 we encountered the problem of trying to solve the equation

$$\sin(\theta(t)) = \frac{r}{d - vt}$$

for $\theta(t)$. We're now going to consider, more generally, problems in which

- we have a given function, that we'll call f , and
- for each number X
- we wish to find a number Y satisfying

$$f(Y) = X. \tag{4.6.1}$$

If we're lucky, then for each real number X there is exactly one real number Y , that we'll call $f^{-1}(X)$, obeying (4.6.1). Then f^{-1} is called the inverse function of f . A (trivial) example in which this happens is given in Example 4.6.1, below.

If we're a little less lucky, there is a set of real numbers \mathcal{D} (that does not contain all of \mathbb{R}) such that

- for each real number X in \mathcal{D} there is exactly one real number Y , that we'll again call $f^{-1}(X)$, obeying (4.6.1) but
- for each real number X that is *not* in \mathcal{D} there is *no* Y obeying (4.6.1).

Then f^{-1} is again called the inverse function of f and \mathcal{D} is called the domain of f^{-1} . We have already seen an example of this — namely $f(x) = e^x$. We'll review this example in Example 4.6.2, below.

If we're yet a little less lucky, there is at least one real number X for which there is more than one real number Y obeying (4.6.1). The trigonometric functions are like this. We'll take a first quick look at this in Example 4.7.1, below and take a more thorough look in the next section, §4.7, below.

Example 4.6.1

Let $f(x) = 2x$. For this $f(x)$, equation (4.6.1) becomes

$$2Y = X$$

For each real number X , there is exactly one Y , namely $Y = \frac{X}{2}$, that obeys $2Y = X$. So, the function $f(x) = 2x$ has inverse function $f^{-1}(X) = \frac{X}{2}$.

Example 4.6.1

Example 4.6.2

Let $f(x) = e^x$. For this $f(x)$, equation (4.6.1) becomes

$$e^Y = X$$

For concreteness, let's pick a specific value of X , say $X = 2$. The graph of e^Y , as a function of Y , is sketched below. In that sketch, the x -axis has been renamed the Y -axis, because we are interested in e^Y as a function of Y . (Be careful to distinguish the upper case Y from the lower case y .) The

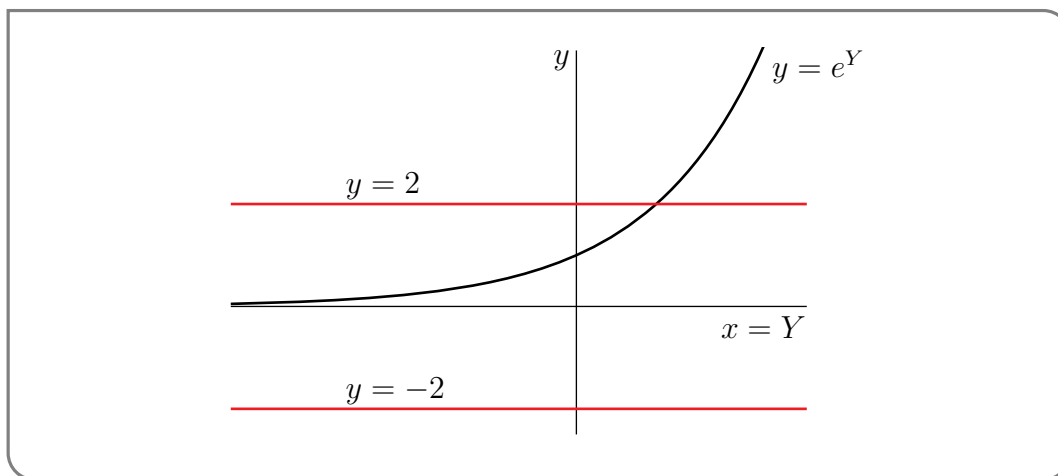

number of Y 's obeying $e^Y = 2$ is exactly the number of times the horizontal straight line $y = 2$ intersects the graph $y = e^Y$, which is one. So for $X = 2$, there is exactly one Y obeying $e^Y = X$. On the other hand, for $X = -2$, the number of Y 's obeying $e^Y = -2$ is exactly the number of times the horizontal straight line $y = -2$ intersects the graph $y = e^Y$, which is zero. So for $X = -2$, no Y 's obey $e^Y = X$.

As Y runs from $-\infty$ to $+\infty$, e^Y takes each strictly positive value exactly once and never takes any value zero or smaller. So the domain of $\ln x$, the inverse function of e^x , is exactly the interval $(0, \infty)$.

Example 4.6.2

Example 4.6.3

Let $f(x) = \sin(x)$. For this $f(x)$, equation (4.6.1) becomes

$$\sin(Y) = X$$

For each fixed real number X , the number of Y 's that obey $\sin(Y) = X$, is exactly the number of times the horizontal straight line $y = X$ intersects the graph $y = \sin(Y)$. When $-1 \leq X \leq 1$, the line $y = X$ intersects the graph $y = \sin(Y)$ infinitely many times. This is illustrated in the figure below by the line $y = 0.3$. On the other hand, when $X < -1$ or $X > 1$, the line $y = X$ never intersects the graph $y = \sin(Y)$. This is illustrated in the figure below by the line $y = -1.2$. We'll see what is normally done about this in §4.7, below.

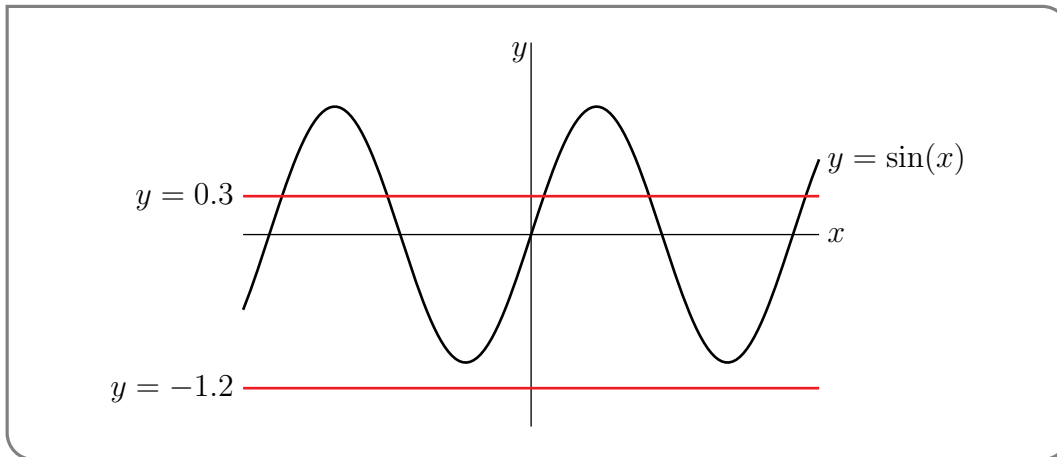

Example 4.6.3

It is an easy matter to construct the graph of an inverse function from the graph of the original function. We just need to remember that

$$Y = f^{-1}(X) \iff f(Y) = X$$

which is $y = f(x)$ with x renamed to Y and y renamed to X .

Start by drawing the graph of f , labelling the x - and y -axes and labelling the curve $y = f(x)$.

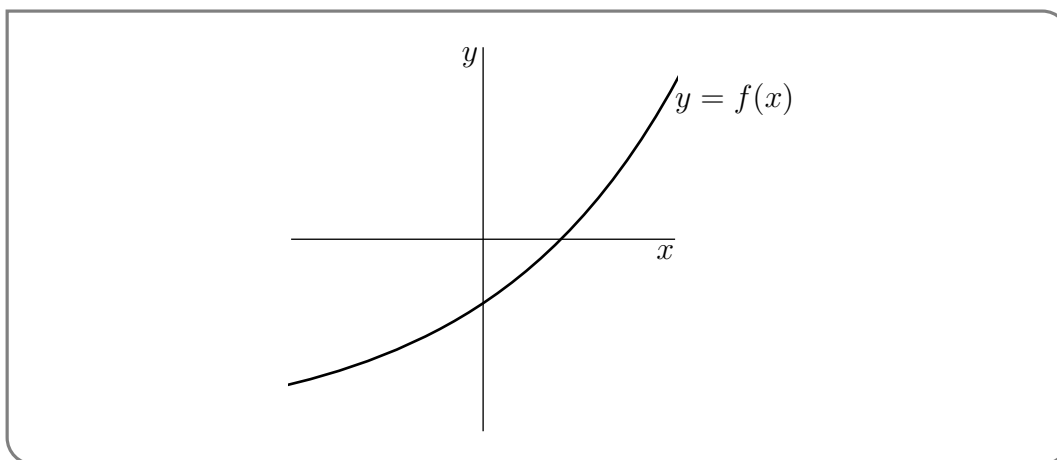

Now replace each x by Y and each y by X and replace the resulting label $X = f(Y)$ on the curve by the equivalent $Y = f^{-1}(X)$.

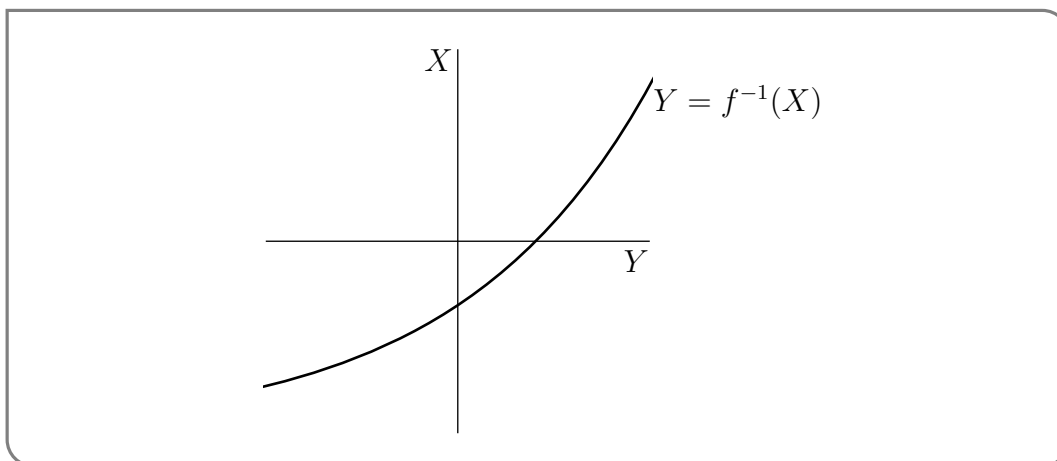

Finally we just need to redraw the sketch with the Y axis running vertically (with Y increasing upwards) and the X axis running horizontally (with X increasing to the right). To do so, pretend that the sketch was on a transparency or on a very thin piece of paper that you can see through. Lift the sketch up and flip it over so that the Y axis runs vertically and the X axis runs horizontally. If you want can also convert the upper case X into a lower case x and the upper case Y into a lower case y .

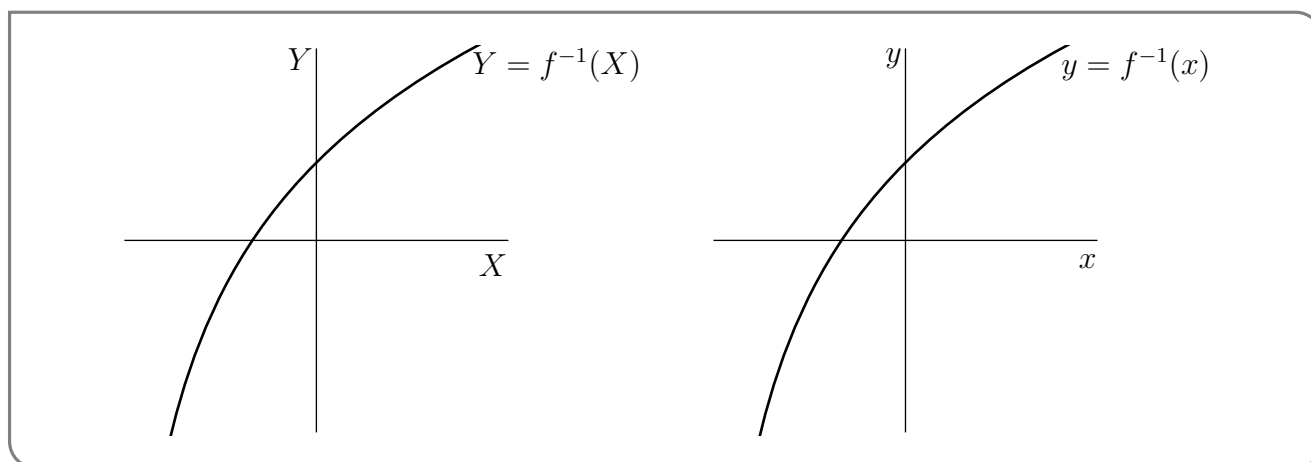

►► Derivatives of inverse functions

It is an easy matter to use implicit differentiation to find a formula for the derivative²² of f^{-1} in terms of the derivative of f . Substitute $Y = f^{-1}(X)$ into $f(Y) = X$ to give

$$f(f^{-1}(X)) = X$$

Rename X to x and apply $\frac{d}{dx}$ to both sides.

$$\frac{d}{dx}f(f^{-1}(x)) = \frac{d}{dx}x = 1$$

By the chain rule

$$f'(f^{-1}(x)) \cdot \frac{d}{dx}f^{-1}(x) = 1 \implies \frac{d}{dx}f^{-1}(x) = \frac{1}{f'(f^{-1}(x))} \quad (4.6.2)$$

22 There is a theorem called the Inverse Function Theorem, which we will not prove, that says that, under reasonable hypotheses on $f(x)$, $f^{-1}(x)$ is differentiable.

Example 4.6.4

The inverse function of $f(x) = e^x$ is $f^{-1}(x) = \log x$. Since $f'(x) = e^x$, (4.6.2) gives

$$\frac{d}{dx} \log x = \frac{1}{e^{\log x}} = \frac{1}{x}.$$

Example 4.6.4

4.7 ▲ Inverse trigonometric functions and their derivatives

Learning Objectives

- Sketch $f(x) = \arctan x$.
- Evaluate (at nice points) the inverse trigonometric functions $\arcsin(x)$, $\arccos(x)$ and $\arctan(x)$.
- Use implicit differentiation / chain rule to find the derivatives of the inverse trigonometric functions $\arcsin(x)$, $\arccos(x)$ and $\arctan(x)$.

We are now going to consider the problem of finding the derivatives of the inverses of trigonometric functions. Most importantly, remind yourself that: given a function $f(x)$, its inverse function $f^{-1}(x)$ only exists, with domain D , when $f(x)$ passes the “horizontal line test”, which says that for each Y in D the horizontal line $y = Y$ intersects the graph $y = f(x)$ exactly once. (That is, $f(x)$ is a one-to-one function.)

Let us start by playing with the sine function and determine how to restrict the domain of $\sin x$ so that its inverse function exists.

Example 4.7.1

Let $y = f(x) = \sin(x)$. We would like to find the inverse function which takes y and returns to us a unique x -value so that $\sin(x) = y$.

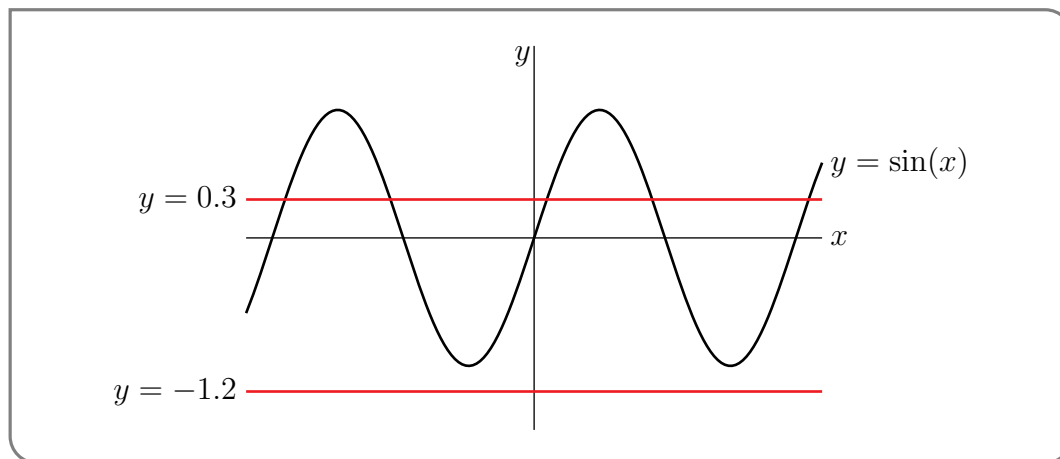

- For each real number Y , the number of x -values that obey $\sin(x) = Y$, is exactly the number of times the horizontal straight line $y = Y$ intersects the graph of $\sin(x)$.
- When $-1 \leq Y \leq 1$, the horizontal line intersects the graph infinitely many times. This is illustrated in the figure above by the line $y = 0.3$.
- On the other hand, when $Y < -1$ or $Y > 1$, the line $y = Y$ never intersects the graph of $\sin(x)$. This is illustrated in the figure above by the line $y = -1.2$.

This is exactly the horizontal line test and it shows that the sine function is not one-to-one.

Now consider the function

$$y = \sin(x) \quad \text{with domain} \quad -\frac{\pi}{2} \leq x \leq \frac{\pi}{2}$$

This function has the same formula but the domain has been restricted so that, as we'll now show, the horizontal line test is satisfied.

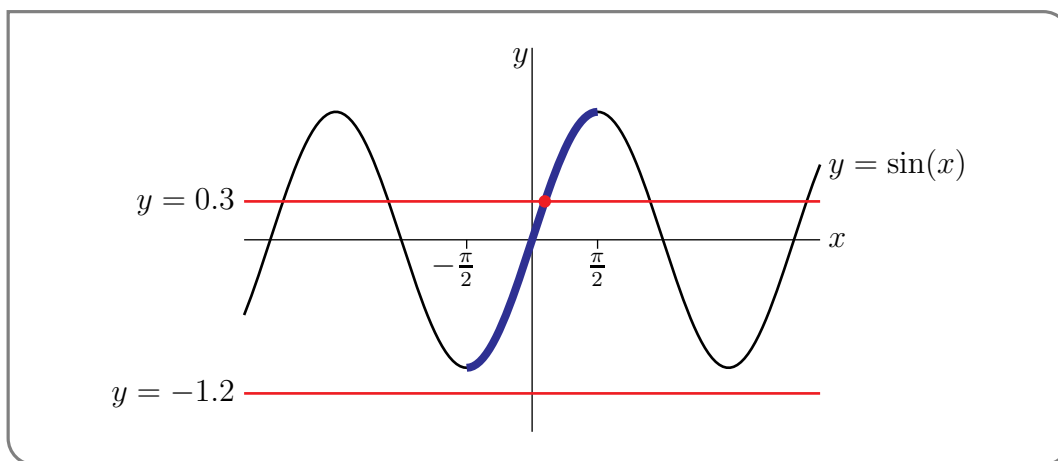

As we saw above when $|Y| > 1$ no x obeys $\sin(x) = Y$ and, for each $-1 \leq Y \leq 1$, the line $y = Y$ (illustrated in the figure above with $y = 0.3$) crosses the curve $y = \sin(x)$ infinitely many times, so that there are infinitely many x 's that obey $f(x) = \sin x = Y$. However exactly one of those crossings (the dot in the figure) has $-\pi/2 \leq x \leq \pi/2$.

That is, for each $-1 \leq Y \leq 1$, there is exactly one x , call it X , that obeys both

$$\sin X = Y \quad \text{and} \quad -\frac{\pi}{2} \leq X \leq \frac{\pi}{2}$$

That unique value, X , is typically denoted $\arcsin(Y)$. That is

$$\sin(\arcsin(Y)) = Y \quad \text{and} \quad -\frac{\pi}{2} \leq \arcsin(Y) \leq \frac{\pi}{2}$$

Renaming $Y \rightarrow x$, the inverse function $\arcsin(x)$ is defined for all $-1 \leq x \leq 1$ and is determined by the equation

$$\sin(\arcsin(x)) = x \quad \text{and} \quad -\frac{\pi}{2} \leq \arcsin(x) \leq \frac{\pi}{2}. \quad (4.7.1)$$

Note that many texts will use $\sin^{-1}(x)$ to denote arcsine, however we will use $\arcsin(x)$ since we feel that it is clearer²³; the reader should recognise both.

23 The main reason being that people frequently confuse $\sin^{-1}(x)$ with $(\sin(x))^{-1} = \frac{1}{\sin x}$. We feel that prepending the prefix "arc" less likely to lead to such confusion. The notations $\text{asin}(x)$ and $\text{Arcsin}(x)$ are also used.

Example 4.7.1

Example 4.7.2

Since

$$\sin \frac{\pi}{2} = 1 \quad \sin \frac{\pi}{6} = \frac{1}{2}$$

and $-\pi/2 \leq \pi/6, \pi/2 \leq \pi/2$, we have

$$\arcsin 1 = \frac{\pi}{2} \quad \arcsin \frac{1}{2} = \frac{\pi}{6}$$

Even though

$$\sin(2\pi) = 0$$

it is **not** true that $\arcsin 0 = 2\pi$, and it is **not** true that $\arcsin(\sin(2\pi)) = 2\pi$, because 2π is not between $-\pi/2$ and $\pi/2$. More generally

$$\begin{aligned} \arcsin(\sin(x)) &= \text{the unique angle } \theta \text{ between } -\pi/2 \text{ and } \pi/2 \text{ obeying } \sin \theta = \sin x \\ &= x \text{ if and only if } -\pi/2 \leq x \leq \pi/2 \end{aligned}$$

So, for example, $\arcsin(\sin(11\pi/16))$ cannot be $11\pi/16$ because $11\pi/16$ is bigger than $\pi/2$. So how do we find the correct answer? Start by sketching the graph of $\sin(x)$.

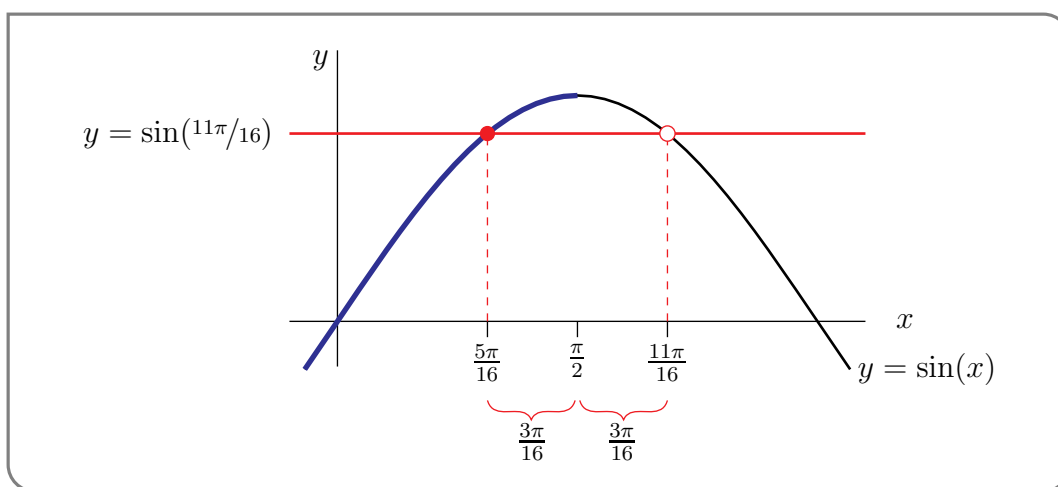

It looks like the graph of $\sin x$ is symmetric about $x = \pi/2$. The mathematical way to say that “the graph of $\sin x$ is symmetric about $x = \pi/2$ ” is “ $\sin(\pi/2 - \theta) = \sin(\pi/2 + \theta)$ ” for all θ . That is indeed true²⁴.

Now $11\pi/16 = \pi/2 + 3\pi/16$ so

$$\sin\left(\frac{11\pi}{16}\right) = \sin\left(\frac{\pi}{2} + \frac{3\pi}{16}\right) = \sin\left(\frac{\pi}{2} - \frac{3\pi}{16}\right) = \sin\left(\frac{5\pi}{16}\right)$$

and, since $5\pi/16$ is indeed between $-\pi/2$ and $\pi/2$,

$$\arcsin\left(\sin\left(\frac{11\pi}{16}\right)\right) = \frac{5\pi}{16} \quad (\text{and not } \frac{11\pi}{16}).$$

Example 4.7.2

24 Indeed both are equal to $\cos \theta$.

►► Derivatives of inverse trig functions

Now that we have explored the arcsine function we are ready to find its derivative. Lets call

$$\arcsin(x) = \theta(x),$$

so that the derivative we are seeking is $\frac{d\theta}{dx}$. The above equation is (after taking sine of both sides) equivalent to

$$\sin(\theta) = x$$

Now differentiate this using implicit differentiation (we just have to remember that θ varies with x and use the chain rule carefully):

$$\begin{aligned} \cos(\theta) \cdot \frac{d\theta}{dx} &= 1 \\ \frac{d\theta}{dx} &= \frac{1}{\cos(\theta)} && \text{substitute } \theta = \arcsin x \\ \frac{d}{dx} \arcsin x &= \frac{1}{\cos(\arcsin x)} \end{aligned}$$

This doesn't look too bad, but it's not really very satisfying because the right hand side is expressed in terms of $\arcsin(x)$ and we do not have an explicit formula for $\arcsin(x)$.

However even without an explicit formula for $\arcsin(x)$, it is a simple matter to get an explicit formula for $\cos(\arcsin(x))$, which is all we need. Just draw a right-angled triangle with one angle being $\arcsin(x)$. This is done in the figure below²⁵.

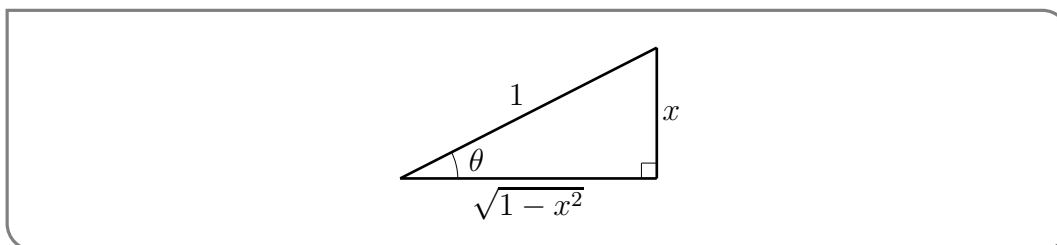

Since $\sin(\theta) = x$ (see (4.7.1)), we have made the side opposite the angle θ of length x and the hypotenuse of length 1. Then, by Pythagoras, the side adjacent to θ has length $\sqrt{1-x^2}$ and so

$$\cos(\arcsin(x)) = \cos(\theta) = \sqrt{1-x^2}$$

which in turn gives us the answer we need:

$$\frac{d}{dx} \arcsin(x) = \frac{1}{\sqrt{1-x^2}}$$

The definitions for arccos, arctan and arccot are developed in the same way. Here are the graphs that are used.

25 The figure is drawn for the case that $0 \leq \arcsin(x) \leq \pi/2$. Virtually the same argument works for the case $-\pi/2 \leq \arcsin(x) \leq 0$

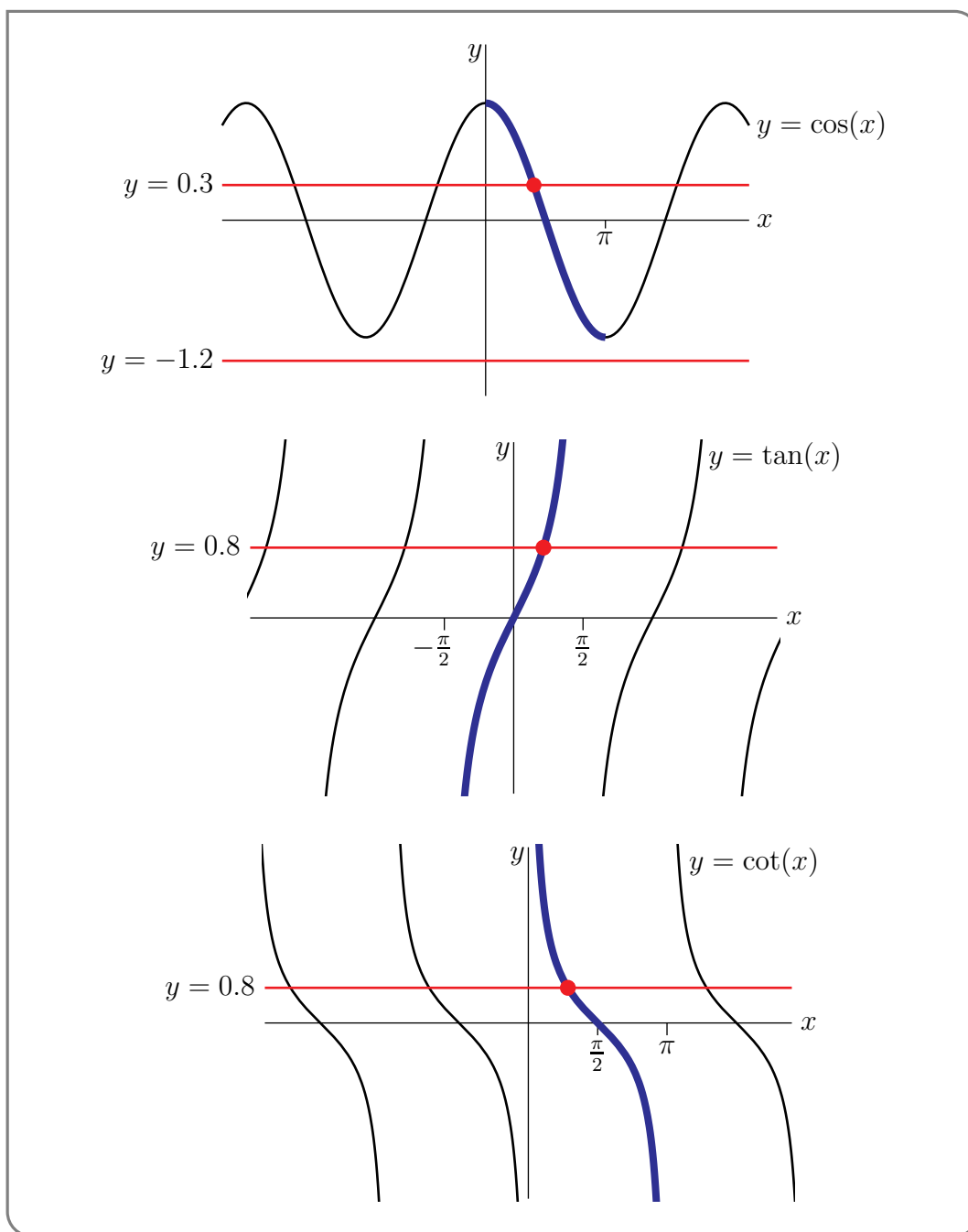

The definitions for the remaining two inverse trigonometric functions may also be developed in the same way^{26,27}. But it's a little easier to use

$$\csc x = \frac{1}{\sin x} \quad \sec x = \frac{1}{\cos x}$$

- 26 In fact, there are two different widely used definitions of $\operatorname{arcsec} x$. Under our definition, below, $\theta = \operatorname{arcsec} x$ takes values in $0 \leq \theta \leq \pi$. Some people, perfectly legitimately, define $\theta = \operatorname{arcsec} x$ to take values in the union of $0 \leq \theta < \frac{\pi}{2}$ and $\pi \leq \theta < \frac{3\pi}{2}$. Our definition is sometimes called the “trigonometry friendly” definition. The definition itself has the advantage of simplicity. The other definition is sometimes called the “calculus friendly” definition. It eliminates some absolute values and hence simplifies some computations. Similarly, there are two different widely used definitions of $\operatorname{arccsc} x$.
- 27 One could also define $\operatorname{arccot}(x) = \operatorname{arctan}(1/x)$ with $\operatorname{arccot}(0) = \frac{\pi}{2}$. We have chosen not to do so, because the definition we have chosen is both continuous and standard.

Definition 4.7.3.

$\arcsin x$ is defined for $|x| \leq 1$. It is the unique number obeying

$$\sin(\arcsin(x)) = x \quad \text{and} \quad -\frac{\pi}{2} \leq \arcsin(x) \leq \frac{\pi}{2}$$

$\arccos x$ is defined for $|x| \leq 1$. It is the unique number obeying

$$\cos(\arccos(x)) = x \quad \text{and} \quad 0 \leq \arccos(x) \leq \pi$$

$\arctan x$ is defined for all $x \in \mathbb{R}$. It is the unique number obeying

$$\tan(\arctan(x)) = x \quad \text{and} \quad -\frac{\pi}{2} < \arctan(x) < \frac{\pi}{2}$$

$\operatorname{arccsc} x = \arcsin \frac{1}{x}$ is defined for $|x| \geq 1$. It is the unique number obeying

$$\csc(\operatorname{arccsc}(x)) = x \quad \text{and} \quad -\frac{\pi}{2} \leq \operatorname{arccsc}(x) \leq \frac{\pi}{2}$$

Because $\csc(0)$ is undefined, $\operatorname{arccsc}(x)$ never takes the value 0.

$\operatorname{arcsec} x = \arccos \frac{1}{x}$ is defined for $|x| \geq 1$. It is the unique number obeying

$$\sec(\operatorname{arcsec}(x)) = x \quad \text{and} \quad 0 \leq \operatorname{arcsec}(x) \leq \pi$$

Because $\sec(\pi/2)$ is undefined, $\operatorname{arcsec}(x)$ never takes the value $\pi/2$.

$\operatorname{arccot} x$ is defined for all $x \in \mathbb{R}$. It is the unique number obeying

$$\cot(\operatorname{arccot}(x)) = x \quad \text{and} \quad 0 < \operatorname{arccot}(x) < \pi$$

Example 4.7.4

To find the derivative of \arccos we can follow the same steps:

- Write $\arccos(x) = \theta(x)$ so that $\cos \theta = x$ and the desired derivative is $\frac{d\theta}{dx}$.
- Differentiate implicitly, remembering that θ is a function of x :

$$\begin{aligned} -\sin \theta \frac{d\theta}{dx} &= 1 \\ \frac{d\theta}{dx} &= -\frac{1}{\sin \theta} \\ \frac{d}{dx} \arccos x &= -\frac{1}{\sin(\arccos x)}. \end{aligned}$$

- To simplify this expression, again draw the relevant triangle

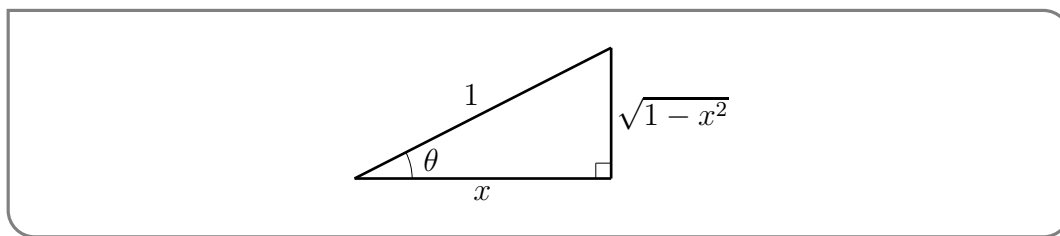

from which we see

$$\sin(\arccos x) = \sin \theta = \sqrt{1-x^2}.$$

- Thus

$$\frac{d}{dx} \arccos x = -\frac{1}{\sqrt{1-x^2}}.$$

Example 4.7.4

Example 4.7.5

Very similar steps give the derivative of $\arctan x$:

- Start with $\theta = \arctan x$, so $\tan \theta = x$.
- Differentiate implicitly:

$$\begin{aligned} \sec^2 \theta \frac{d\theta}{dx} &= 1 \\ \frac{d\theta}{dx} &= \frac{1}{\sec^2 \theta} = \cos^2 \theta \\ \frac{d}{dx} \arctan x &= \cos^2(\arctan x). \end{aligned}$$

- To simplify this expression, we draw the relevant triangle

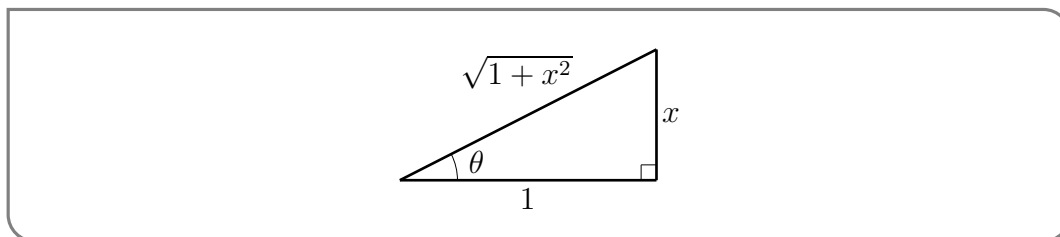

from which we see

$$\cos^2(\arctan x) = \cos^2 \theta = \frac{1}{1+x^2}$$

- Thus

$$\frac{d}{dx} \arctan x = \frac{1}{1+x^2}.$$

An almost identical computation gives the derivative of $\operatorname{arccot} x$:

- Start with $\theta = \operatorname{arccot} x$, so $\cot \theta = x$.
- Differentiate implicitly:

$$-\csc^2 \theta \frac{d\theta}{dx} = 1$$

$$\frac{d}{dx} \operatorname{arccot} x = \frac{d\theta}{dx} = -\frac{1}{\csc^2 \theta} = -\sin^2 \theta = -\frac{1}{1+x^2}$$

from the triangle

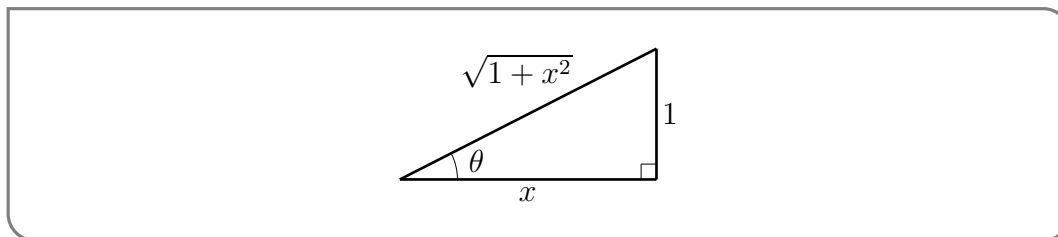

Example 4.7.5

Example 4.7.6

To find the derivative of $\operatorname{arccsc} x$ we can use its definition and the chain rule.

$$\begin{aligned} \theta &= \operatorname{arccsc} x && \text{take cosecant of both sides} \\ \csc \theta &= x && \text{but } \csc \theta = \frac{1}{\sin \theta}, \text{ so flip both sides} \\ \sin \theta &= \frac{1}{x} && \text{now take arcsine of both sides} \\ \theta &= \arcsin \left(\frac{1}{x} \right) \end{aligned}$$

Now just differentiate:

$$\begin{aligned} \frac{d\theta}{dx} &= \frac{d}{dx} \arcsin \left(\frac{1}{x} \right) && \text{chain rule carefully} \\ &= \frac{1}{\sqrt{1-x^{-2}}} \cdot \frac{-1}{x^2} \end{aligned}$$

To simplify further we will factor x^{-2} out of the square root. We need to be a little careful doing that. Take another look at examples 2.1.33 and 2.1.34 and the discussion between them before proceeding.

$$\begin{aligned} &= \frac{1}{\sqrt{x^{-2}(x^2-1)}} \cdot \frac{-1}{x^2} \\ &= \frac{1}{|x^{-1}| \cdot \sqrt{x^2-1}} \cdot \frac{-1}{x^2} && \text{note that } x^2 \cdot |x^{-1}| = |x|. \\ &= -\frac{1}{|x|\sqrt{x^2-1}} \end{aligned}$$

In the same way, we can find the derivative of the remaining inverse trig function. We just use its definition, a derivative we already know and the chain rule.

$$\frac{d}{dx} \operatorname{arcsec}(x) = \frac{d}{dx} \arccos\left(\frac{1}{x}\right) = -\frac{1}{\sqrt{1-1/x^2}} \cdot \left(-\frac{1}{x^2}\right) = \frac{1}{|x|\sqrt{x^2-1}}$$

Example 4.7.6

By way of summary, we have

Theorem 4.7.7.

The derivatives of the inverse trigonometric functions are

$$\frac{d}{dx} \arcsin(x) = \frac{1}{\sqrt{1-x^2}}$$

$$\frac{d}{dx} \operatorname{arccsc}(x) = -\frac{1}{|x|\sqrt{x^2-1}}$$

$$\frac{d}{dx} \arccos(x) = -\frac{1}{\sqrt{1-x^2}}$$

$$\frac{d}{dx} \operatorname{arcsec}(x) = \frac{1}{|x|\sqrt{x^2-1}}$$

$$\frac{d}{dx} \arctan(x) = \frac{1}{1+x^2}$$

$$\frac{d}{dx} \operatorname{arccot}(x) = -\frac{1}{1+x^2}$$

Applications of Differentiation

In Section 3.3.2 we defined the derivative at $x = a$, $f'(a)$, of an abstract function $f(x)$, to be its instantaneous rate of change at $x = a$:

$$f'(a) = \lim_{x \rightarrow a} \frac{f(x) - f(a)}{x - a}$$

This abstract definition, and the whole theory that we have developed to deal with it, turns out to be extremely useful simply because “instantaneous rate of change” appears in a huge number of settings. Here are a few examples.

- If you are moving along a line and $x(t)$ is your position on the line at time t , then your rate of change of position, $x'(t)$, is your velocity. If, instead, $v(t)$ is your velocity at time t , then your rate of change of velocity, $v'(t)$, is your acceleration.
- If $P(t)$ is the size of some population (say the number of humans on the earth) at time t , then $P'(t)$ is the rate at which the size of that population is changing. It is called the net birth rate.
- Radiocarbon dating, a procedure used to determine the age of, for example, archaeological materials, is based on an understanding of the rate at which an unstable isotope of carbon decays.
- A capacitor is an electrical component that is used to repeatedly store and release electrical charge (say electrons) in an electronic circuit. If $Q(t)$ is the charge on a capacitor at time t , then $Q'(t)$ is the instantaneous rate at which charge is flowing into the capacitor. That's called the current. The standard unit of charge is the coulomb. One coulomb is the magnitude of the charge of approximately 6.241×10^{18} electrons. The standard unit for current is the amp. One amp represents one coulomb per second.

RELATED RATES

Learning Objectives

- Implement a sequence of steps to solve related rates problems.

Consider the following problem

A spherical balloon is being inflated at a rate of $13\text{cm}^3/\text{sec}$. How fast is the radius changing when the balloon has radius 15cm ?

There are several pieces of information in the statement:

- The balloon is spherical
- The volume is changing at a rate of $13\text{cm}^3/\text{sec}$ — so we need variables for volume (in cm^3) and time (in sec). Good choices are V and t .
- We are asked for the rate at which the radius is changing — so we need a variable for radius and units. A good choice is r , measured in cm — since volume is measured in cm^3 .

Since the balloon is a sphere we know that

$$V = \frac{4}{3}\pi r^3$$

Since both the volume and radius are changing with time, both V and r are implicitly functions of time; we could really write

$$V(t) = \frac{4}{3}\pi r(t)^3.$$

We are told the rate at which the volume is changing and we need to find the rate at which the radius is changing. That is, from a knowledge of $\frac{dV}{dt}$, find the related rate¹ $\frac{dr}{dt}$.

1 Related rate problems are problems in which you are given the rate of change of one quantity and are to determine the rate of change of another, related, quantity.

In this case, we can just differentiate our equation by t to get

$$\frac{dV}{dt} = 4\pi r^2 \frac{dr}{dt}$$

This can then be rearranged to give

$$\frac{dr}{dt} = \frac{1}{4\pi r^2} \frac{dV}{dt}$$

Now we were told that $\frac{dV}{dt} = 13$, so

$$\frac{dr}{dt} = \frac{13}{4\pi r^2}$$

We were also told that the radius is 15cm , so at that moment in time

$$\frac{dr}{dt} = \frac{13}{\pi 4 \times 15^2}$$

This is a very typical example of a related rate problem. This section is really just a collection of problems, but all will follow a similar pattern.

- The statement of the problem will tell you quantities that must be related (above it was volume, radius and, implicitly, time).
- Typically a little geometry (or some physics or...) will allow you to relate these quantities (above it was the formula that links the volume of a sphere to its radius).
- Implicit differentiation will then allow you to link the rate of change of one quantity to another.

Another balloon example

Example 5.0.1

Consider a helium balloon rising vertically from a fixed point 200m away from you. You are trying to work out how fast it is rising. Now — computing the velocity directly is difficult, but you can measure angles. You observe that when it is at an angle of $\pi/4$ its angle is changing by 0.05 radians per second.

- Start by drawing a picture with the relevant variables

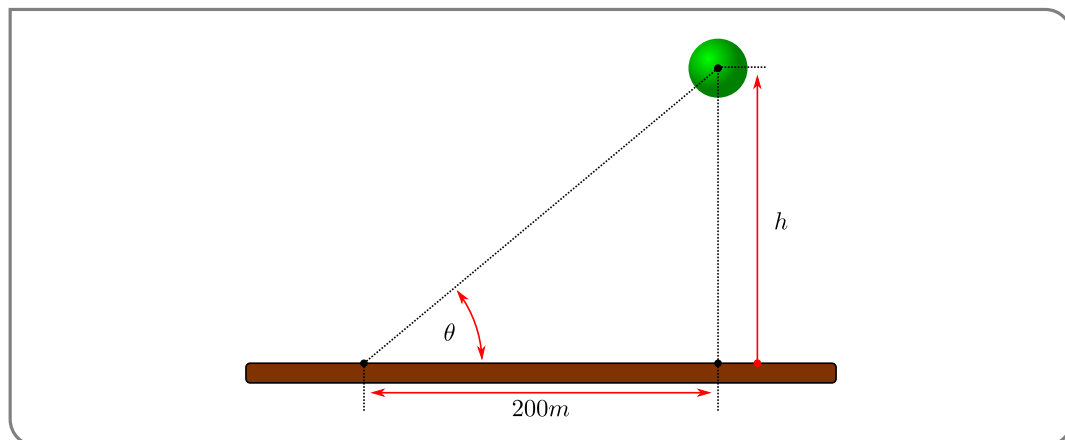

- So denote the angle to be θ (in radians), the height of the balloon (in m) by h and time (in seconds) by t . Then trigonometry tells us

$$h = 200 \cdot \tan \theta$$

- Differentiating allows us to relate the rates of change

$$\frac{dh}{dt} = 200 \sec^2 \theta \cdot \frac{d\theta}{dt}$$

- We are told that when $\theta = \pi/4$ we observe $\frac{d\theta}{dt} = 0.05$, so

$$\begin{aligned} \frac{dh}{dt} &= 200 \cdot \sec^2(\pi/4) \cdot 0.05 \\ &= 200 \cdot 0.05 \cdot (\sqrt{2})^2 \\ &= 200 \cdot \frac{5}{100} \cdot 2 && = 20m/s \end{aligned}$$

- So the balloon is rising at a rate of 20m/s.

Example 5.0.1

The following problem is perhaps *the* classic related rate problem.

Example 5.0.2

A 5m ladder is leaning against a wall. The floor is quite slippery and the base of the ladder slides out from the wall at a rate of $1m/s$. How fast is the top of the ladder sliding down the wall when the base of the ladder is 3m from the wall?

- A good first step is to draw a picture stating all relevant quantities. This will also help us define variables and units.

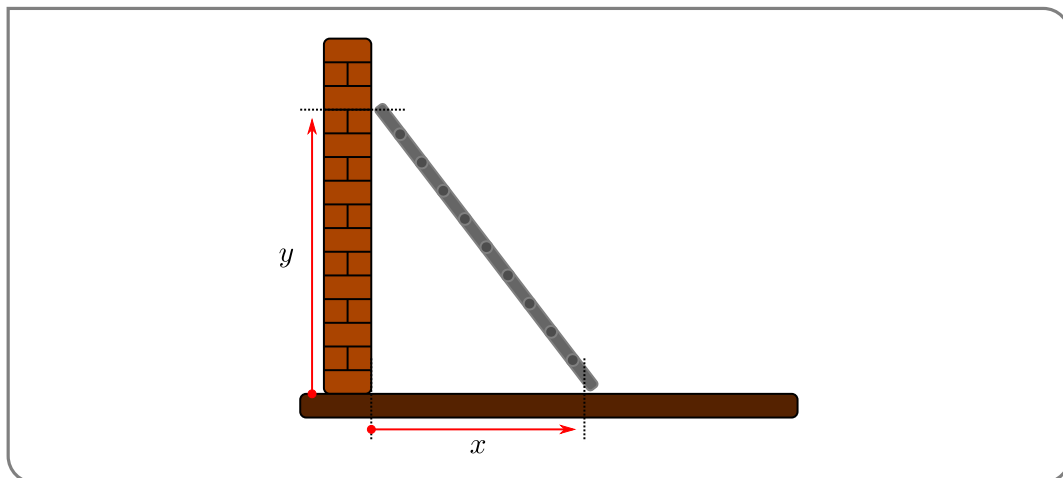

- So now define $x(t)$ to be the distance between the bottom of the ladder and the wall, at time t , and let $y(t)$ be the distance between the top of the ladder and the ground at time t . Measure time in seconds, but both distances in meters.

- We can relate the quantities using Pythagoras:

$$x^2 + y^2 = 5^2$$

- Differentiating with respect to time then gives

$$2x \frac{dx}{dt} + 2y \frac{dy}{dt} = 0$$

- We know that $\frac{dx}{dt} = 1$ and $x = 3$, so

$$6 \cdot 1 + 2y \frac{dy}{dt} = 0$$

but we need to determine y before we can go further. Thankfully we know that $x^2 + y^2 = 25$ and $x = 3$, so $y^2 = 25 - 9 = 16$ and² so $y = 4$.

- So finally putting everything together

$$6 \cdot 1 + 8 \frac{dy}{dt} = 0$$

$$\frac{dy}{dt} = -\frac{3}{4} m/s.$$

Thus the top of the ladder is sliding towards the floor at a rate of $3/4m/s$.

Example 5.0.2

The next example is complicated by the rates of change being stated not just as “the rate of change per unit time” but instead being stated as “the percentage rate of change per unit time”. If a quantity f is changing with rate $\frac{df}{dt}$, then we can say that

f is changing at a rate of $100 \cdot \frac{df}{f}$ percent.

Thus if, at time t , f has rate of change $r\%$, then

$$100 \frac{f'(t)}{f(t)} = r \implies f'(t) = \frac{r}{100} f(t)$$

so that if h is a very small time increment

$$\frac{f(t+h) - f(t)}{h} \approx \frac{r}{100} f(t) \implies f(t+h) \approx f(t) + \frac{rh}{100} f(t)$$

That is, over a very small time interval h , f increases by the fraction $\frac{rh}{100}$ of its value at time t .

So armed with this, let’s look at the problem.

Example 5.0.3

The quantities P , Q and R are functions of time and are related by the equation $R = PQ$. Assume

2 Since the ladder isn’t buried in the ground, we can discard the solution $y = -4$.

that P is increasing instantaneously at the rate of 8% per year (meaning that $100\frac{P'}{P} = 8$) and that Q is decreasing instantaneously at the rate of 2% per year (meaning that $100\frac{Q'}{Q} = -2$). Determine the percentage rate of change for R .

Solution. This one is a little different — we are given the variables and the formula, so no picture drawing or defining required. Though we do need to define a time variable — let t denote time in years.

- Since $R(t) = P(t) \cdot Q(t)$ we can differentiate with respect to t to get

$$\frac{dR}{dt} = PQ' + QP'$$

- But we need the percentage change in R , namely

$$100\frac{R'}{R} = 100\frac{PQ' + QP'}{R}$$

but $R = PQ$, so rewrite it as

$$\begin{aligned} &= 100\frac{PQ' + QP'}{PQ} \\ &= 100\frac{PQ'}{PQ} + 100\frac{QP'}{PQ} \\ &= 100\frac{Q'}{Q} + 100\frac{P'}{P} \end{aligned}$$

so we have stated the instantaneous percentage rate of change in R as the sum of the percentage rate of change in P and Q .

- We know the percentage rate of change of P and Q , so

$$100\frac{R'}{R} = -2 + 8 = 6$$

That is, the instantaneous percentage rate of change of R is 6% per year.

Example 5.0.3

Yet another falling object example.

Example 5.0.4

A ball is dropped from a height of 49m above level ground. The height of the ball at time t is $h(t) = 49 - 4.9t^2$ m. A light, which is also 49m above the ground, is 10m to the left of the ball's original position. As the ball descends, the shadow of the ball caused by the light moves across the ground. How fast is the shadow moving one second after the ball is dropped?

Solution. There is quite a bit going on in this example, so read carefully.

- First a diagram; the one below is perhaps a bit over the top.

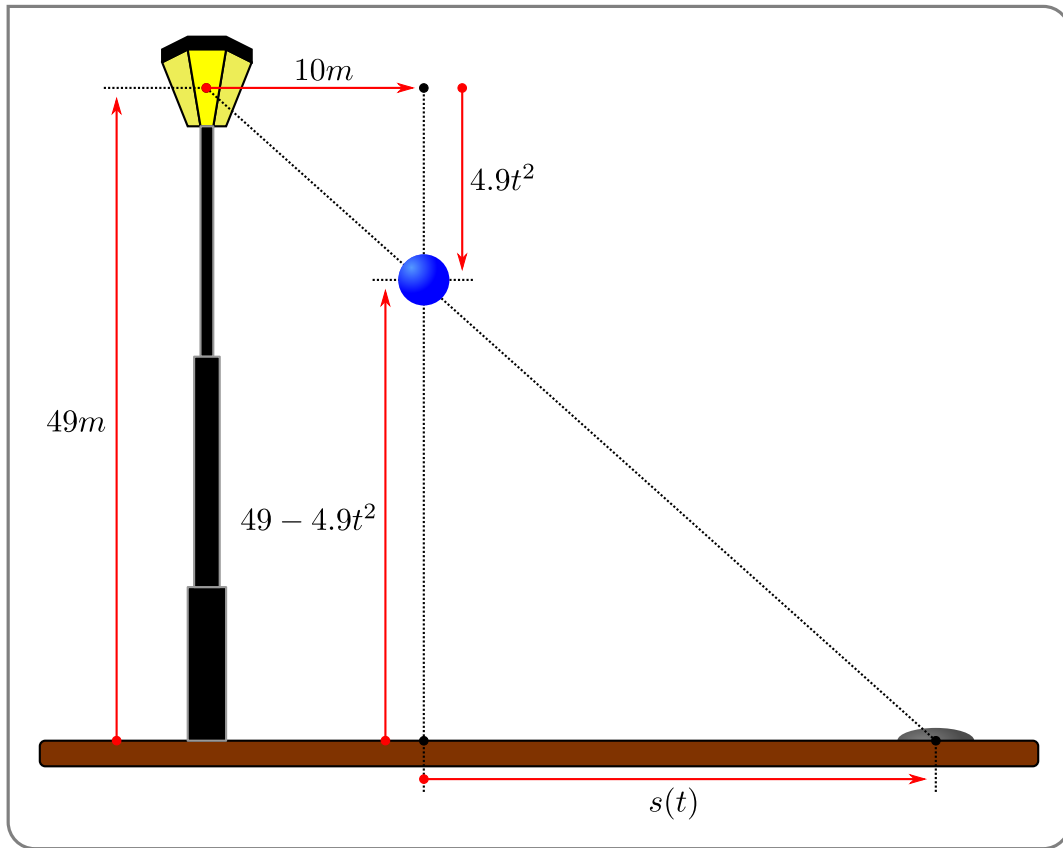

- Let's call $s(t)$ the distance from the shadow to the point on the ground directly underneath the ball.
- By similar triangles we see that

$$\frac{4.9t^2}{10} = \frac{49 - 4.9t^2}{s(t)}$$

We can then solve for $s(t)$ by just multiplying both sides by $\frac{10}{4.9t^2}s(t)$. This gives

$$s(t) = 10 \frac{49 - 4.9t^2}{4.9t^2} = \frac{100}{t^2} - 10$$

- Differentiating with respect to t will then give us the rates,

$$s'(t) = -2 \frac{100}{t^3}$$

- So, at $t = 1$, $s'(1) = -200$ m/sec. That is, the shadow is moving to the left at 200m/sec.

Example 5.0.4

A more nautical example.

Example 5.0.5

Two boats spot each other in the ocean at midday — Boat A is 15km west of Boat B. Boat A is

travelling east at 3km/h and boat B is travelling north at 4km/h. At 3pm how fast is the distance between the boats changing.

- First we draw a picture.

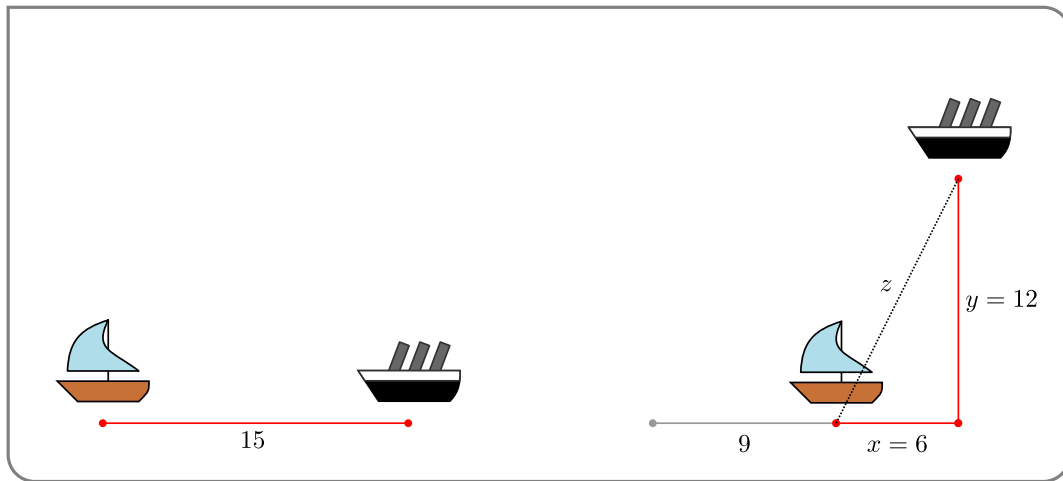

- Let $x(t)$ be the distance at time t , in km, from boat A to the original position of boat B (i.e. to the position of boat B at noon). And let $y(t)$ be the distance at time t , in km, of boat B from its original position. And let $z(t)$ be the distance between the two boats at time t .
- Additionally we are told that $x' = -3$ and $y' = 4$ — notice that $x' < 0$ since that distance is getting smaller with time, while $y' > 0$ since that distance is increasing with time.
- Further at 3pm boat A has travelled 9km towards the original position of boat B , so $x = 15 - 9 = 6$, while boat B has travelled 12km away from its original position, so $y = 12$.
- The distances x, y and z form a right-angled triangle, and Pythagoras tells us that

$$z^2 = x^2 + y^2.$$

At 3pm we know $x = 6, y = 12$ so

$$z^2 = 36 + 144 = 180$$

$$z = \sqrt{180} = 6\sqrt{5}.$$

- Differentiating then gives

$$\begin{aligned} 2z \frac{dz}{dt} &= 2x \frac{dx}{dt} + 2y \frac{dy}{dt} \\ &= 12 \cdot (-3) + 24 \cdot (4) \\ &= 60. \end{aligned}$$

Dividing through by $2z = 12\sqrt{5}$ then gives

$$\frac{dz}{dt} = \frac{60}{12\sqrt{5}} = \frac{5}{\sqrt{5}} = \sqrt{5}$$

So the distance between the boats is increasing at $\sqrt{5} \text{ km/h}$.

Example 5.0.5

One last one before we move on to another topic.

Example 5.0.6

Consider a cylindrical fuel tank of radius r and length L (in some appropriate units) that is lying on its side. Suppose that fuel is being pumped into the tank at a rate q . At what rate is the fuel level rising?

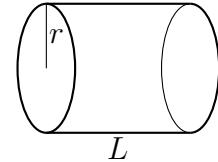

Solution. If the tank were vertical everything would be much easier. Unfortunately the tank is on its side, so we are going to have to work a bit harder to establish the relation between the depth and volume. Also notice that we have not been supplied with units for this problem — so we do not need to state the units of our variables.

- Again — draw a picture. Here is an end view of the tank; the shaded part of the circle is filled with fuel.

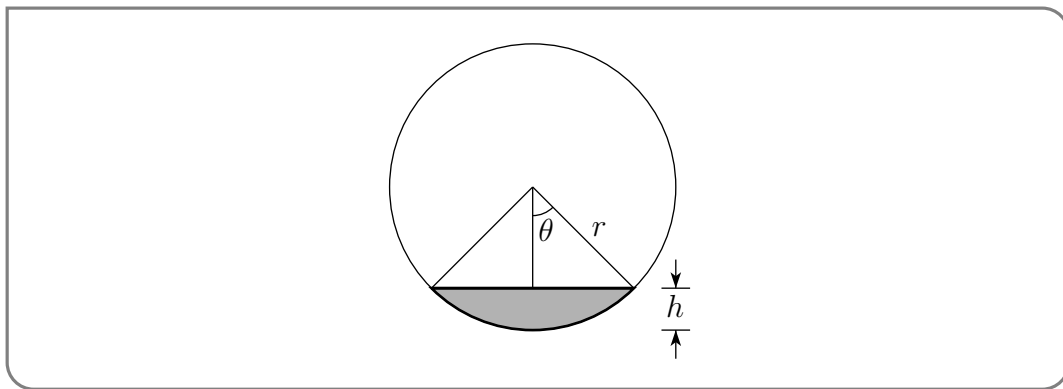

- Let us denote by $V(t)$ the volume of fuel in the tank at time t and by $h(t)$ the fuel level at time t .
- We have been told that $V'(t) = q$ and have been asked to determine $h'(t)$. While it is possible to do so by finding a formula relating $V(t)$ and $h(t)$, it turns out to be quite a bit easier to first find a formula relating V and the angle θ shown in the end view. We can then translate this back into a formula in terms of h using the relation

$$h(t) = r - r \cos \theta(t).$$

Once we know $\theta'(t)$, we can easily obtain $h'(t)$ by differentiating the above equation.

- The computation that follows below gets a little involved in places, so we will drop the “ (t) ” on the variables V, h and θ . The reader must never forget that these three quantities are really functions of time, while r and L are constants that do not depend on time.
- The volume of fuel is L times the cross-sectional area filled by the fuel. That is,

$$V = L \times \text{Area}(\text{☾})$$

While we do not have a canned formula for the area of a chord of a circle like this, it is easy to express the area of the chord in terms of two areas that we can compute.

$$V = L \times \text{Area}(\text{---}) = L \times \left[\text{Area}(\text{---}) - \text{Area}(\text{---}) \right]$$

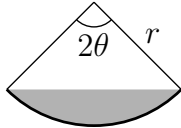
- The piece of pie  is the fraction $\frac{2\theta}{2\pi}$ of the full circle, so its area is $\frac{2\theta}{2\pi} \pi r^2 = \theta r^2$.

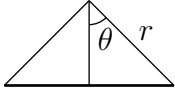
- The triangle  has height $r \cos \theta$ and base $2r \sin \theta$ and hence has area $\frac{1}{2}(r \cos \theta)(2r \sin \theta) = r^2 \sin \theta \cos \theta = \frac{r^2}{2} \sin(2\theta)$, where we have used a double-angle formula.

Subbing these two areas into the above expression for V gives

$$V = L \times \left[\theta r^2 - \frac{r^2}{2} \sin 2\theta \right] = \frac{Lr^2}{2} [2\theta - \sin 2\theta]$$

Oof!

- Now we can differentiate to find the rate of change. Recalling that $V = V(t)$ and $\theta = \theta(t)$, while r and L are constants,

$$\begin{aligned} V' &= \frac{Lr^2}{2} [2\theta' - 2 \cos 2\theta \cdot \theta'] \\ &= Lr^2 \cdot \theta' \cdot [1 - \cos 2\theta] \end{aligned}$$

Solving this for θ' and using $V' = q$ gives

$$\theta' = \frac{q}{Lr^2(1 - \cos 2\theta)}$$

This is the rate at which θ is changing, but we need the rate at which h is changing. We get this from

$$\begin{aligned} h &= r - r \cos \theta && \text{differentiating this gives} \\ h' &= r \sin \theta \cdot \theta' \end{aligned}$$

Substituting our expression for θ' into the expression for h' gives

$$h' = r \sin \theta \cdot \frac{q}{Lr^2(1 - \cos 2\theta)}$$

- We can clean this up a bit more — recall more double-angle formulas

$$\begin{aligned} h' &= r \sin \theta \cdot \frac{q}{Lr^2(1 - \cos 2\theta)} && \text{substitute } \cos 2\theta = 1 - 2 \sin^2 \theta \\ &= r \sin \theta \cdot \frac{q}{Lr^2 \cdot 2 \sin^2 \theta} && \text{now cancel } r\text{'s and a } \sin \theta \\ &= \frac{q}{2Lr \sin \theta} \end{aligned}$$

- But we can clean this up even more — instead of writing this rate in terms of θ it is more natural to write it in terms of h (since the initial problem is stated in terms of h). From the triangle

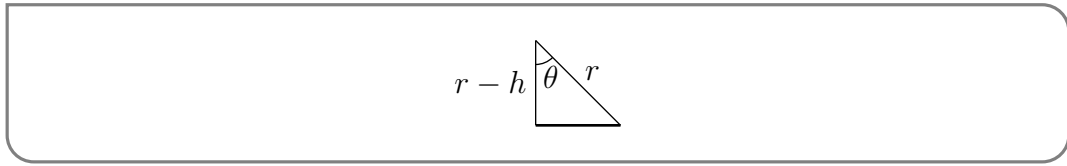

and Pythagoras we have

$$\sin \theta = \frac{\sqrt{r^2 - (r-h)^2}}{r} = \frac{\sqrt{2rh - h^2}}{r}$$

and hence

$$h' = \frac{q}{2L\sqrt{2rh - h^2}}.$$

- As a check, notice that h' becomes undefined when $h < 0$ and also when $h > 2r$, because then the argument of the square root in the denominator is negative. Both make sense — the fuel level in the tank must obey $0 \leq h \leq 2r$.

Example 5.0.6

L'HÔPITAL'S RULE AND INDETERMINATE FORMS

Learning Objectives

- Recognize the two types of indeterminate forms where L'Hôpital's rule is directly applicable.
- Use L'Hôpital's rule to evaluate limits; compare/contrast with asymptotics.

Let us return to limits (Chapter 2) and see how we can use derivatives to simplify certain families of limits called indeterminate forms. We know, from Theorem 2.1.15 on the arithmetic of limits, that if

$$\lim_{x \rightarrow a} f(x) = F$$

$$\lim_{x \rightarrow a} g(x) = G$$

and $G \neq 0$, then

$$\lim_{x \rightarrow a} \frac{f(x)}{g(x)} = \frac{F}{G}$$

The requirement that $G \neq 0$ is critical — we explored this in Example 2.1.19. Please reread that example.

Of course¹ it is not surprising that if $F \neq 0$ and $G = 0$, then

$$\lim_{x \rightarrow a} \frac{f(x)}{g(x)} = DNE$$

and if $F = 0$ but $G \neq 0$ then

$$\lim_{x \rightarrow a} \frac{f(x)}{g(x)} = 0$$

¹ Now it is not so surprising, but perhaps back when we started limits, this was not so obvious.

However when both $F, G = 0$ then, as we saw in Example 2.1.19, almost anything can happen

$f(x) = x$	$g(x) = x^2$	$\lim_{x \rightarrow 0} \frac{x}{x^2} = \lim_{x \rightarrow 0} \frac{1}{x} = DNE$
$f(x) = x^2$	$g(x) = x$	$\lim_{x \rightarrow 0} \frac{x^2}{x} = \lim_{x \rightarrow 0} x = 0$
$f(x) = x$	$g(x) = x$	$\lim_{x \rightarrow 0} \frac{x}{x} = \lim_{x \rightarrow 0} 1 = 1$
$f(x) = 7x^2$	$g(x) = 3x^2$	$\lim_{x \rightarrow 0} \frac{7x^2}{3x^2} = \lim_{x \rightarrow 0} \frac{7}{3} = \frac{7}{3}$

Indeed after exploring Example 2.1.24 and 2.1.26 we gave ourselves the rule of thumb that if we found $0/0$, then there must be something that cancels.

Because the limit that results from these $0/0$ situations is not immediately obvious, but also leads to some interesting mathematics, we should give it a name.

Definition 6.0.1 (First indeterminate forms).

Let $a \in \mathbb{R}$ and let $f(x)$ and $g(x)$ be functions. If

$$\lim_{x \rightarrow a} f(x) = 0 \qquad \text{and} \qquad \lim_{x \rightarrow a} g(x) = 0$$

then the limit

$$\lim_{x \rightarrow a} \frac{f(x)}{g(x)}$$

is called a $0/0$ indeterminate form.

There are quite a number of mathematical tools for evaluating such indeterminate forms — Taylor series for example. A simpler method, which works in quite a few cases, is L'Hôpital's rule².

2 Named for the 17th century mathematician, Guillaume de l'Hôpital, who published the first textbook on differential calculus. The eponymous rule appears in that text, but is believed to have been developed by Johann Bernoulli. The book was the source of some controversy since it contained many results by Bernoulli, which l'Hôpital acknowledged in the preface, but Bernoulli felt that l'Hôpital got undue credit. Note that around that time l'Hôpital's name was commonly spelled l'Hospital, but the spelling of silent s in French was changed subsequently; many texts spell his name l'Hospital. If you find yourself in Paris, you can hunt along Boulevard de l'Hôpital for older street signs carved into the sides of buildings which spell it "l'Hospital" — though arguably there are better things to do there.

Theorem 6.0.2 (L'Hôpital's Rule).

Let $a \in \mathbb{R}$ and assume that

$$\lim_{x \rightarrow a} f(x) = \lim_{x \rightarrow a} g(x) = 0$$

Then

(a) if $f'(a)$ and $g'(a)$ exist and $g'(a) \neq 0$, then

$$\lim_{x \rightarrow a} \frac{f(x)}{g(x)} = \frac{f'(a)}{g'(a)},$$

(b) while, if $f'(x)$ and $g'(x)$ exist, with $g'(x)$ nonzero, on an open interval that contains a , except possibly at a itself, and if the limit

$$\lim_{x \rightarrow a} \frac{f'(x)}{g'(x)} \text{ exists or is } +\infty \text{ or is } -\infty$$

then

$$\lim_{x \rightarrow a} \frac{f(x)}{g(x)} = \lim_{x \rightarrow a} \frac{f'(x)}{g'(x)}$$

Proof. We only give the proof for part (a). The proof of part (b) is not very difficult, but uses the Generalised Mean-Value Theorem (Theorem 9.7.2), which is optional and most readers have not seen it.

- First note that we must have $f(a) = g(a) = 0$. To see this note that since derivative $f'(a)$ exists, we know that the limit

$$\lim_{x \rightarrow a} \frac{f(x) - f(a)}{x - a} \text{ exists}$$

Since we know that the denominator goes to zero, we must also have that the numerator goes to zero (otherwise the limit would be undefined). Hence we must have

$$\lim_{x \rightarrow a} (f(x) - f(a)) = \left(\lim_{x \rightarrow a} f(x) \right) - f(a) = 0$$

We are told that $\lim_{x \rightarrow a} f(x) = 0$ so we must have $f(a) = 0$. Similarly we know that $g(a) = 0$.

- Now consider the indeterminate form

$$\begin{aligned}
 \lim_{x \rightarrow a} \frac{f(x)}{g(x)} &= \lim_{x \rightarrow a} \frac{f(x) - 0}{g(x) - 0} && \text{use } 0 = f(a) = g(a) \\
 &= \lim_{x \rightarrow a} \frac{f(x) - f(a)}{g(x) - g(a)} && \text{multiply by } 1 = \frac{(x-a)^{-1}}{(x-a)^{-1}} \\
 &= \lim_{x \rightarrow a} \frac{f(x) - f(a)}{g(x) - g(a)} \cdot \frac{(x-a)^{-1}}{(x-a)^{-1}} && \text{rearrange} \\
 &= \lim_{x \rightarrow a} \left[\frac{\frac{f(x) - f(a)}{x-a}}{\frac{g(x) - g(a)}{x-a}} \right] && \text{use arithmetic of limits} \\
 &= \frac{\lim_{x \rightarrow a} \frac{f(x) - f(a)}{x-a}}{\lim_{x \rightarrow a} \frac{g(x) - g(a)}{x-a}} = \frac{f'(a)}{g'(a)}
 \end{aligned}$$

We can justify this step and apply Theorem 2.1.15, since the limits in the numerator and denominator exist, because they are just $f'(a)$ and $g'(a)$.

□

6.1 ▸ Standard examples

Here are some simple examples using L'Hôpital's rule.

Example 6.1.1

Consider the limit

$$\lim_{x \rightarrow 0} \frac{\sin x}{x}$$

- Notice that

$$\begin{aligned}
 \lim_{x \rightarrow 0} \sin x &= 0 \\
 \lim_{x \rightarrow 0} x &= 0
 \end{aligned}$$

so this is a $0/0$ indeterminate form, and suggests we try l'Hôpital's rule.

- To apply the rule we must first check the limits of the derivatives.

$$\begin{array}{llll}
 f(x) = \sin x & f'(x) = \cos x & \text{and} & f'(0) = 1 \\
 g(x) = x & g'(x) = 1 & \text{and} & g'(0) = 1
 \end{array}$$

- So by l'Hôpital's rule

$$\lim_{x \rightarrow 0} \frac{\sin x}{x} = \frac{f'(0)}{g'(0)} = \frac{1}{1} = 1.$$

Example 6.1.1

Example 6.1.2

Consider the limit

$$\lim_{x \rightarrow 0} \frac{\sin(x)}{\sin(2x)}$$

- First check

$$\lim_{x \rightarrow 0} \sin 2x = 0$$

$$\lim_{x \rightarrow 0} \sin x = 0$$

so we again have a $0/0$ indeterminate form.

- Set $f(x) = \sin x$ and $g(x) = \sin 2x$, then

$$f'(x) = \cos x$$

$$g'(x) = 2 \cos 2x$$

$$f'(0) = 1$$

$$g'(0) = 2$$

- And by l'Hôpital's rule

$$\lim_{x \rightarrow 0} \frac{\sin x}{\sin 2x} = \frac{f'(0)}{g'(0)} = \frac{1}{2}.$$

Example 6.1.2

Example 6.1.3

Let $q > 1$ and compute the limit

$$\lim_{x \rightarrow 0} \frac{q^x - 1}{x}$$

This limit arose in our discussion of exponential functions in Section 3.5.

- First check

$$\lim_{x \rightarrow 0} (q^x - 1) = 1 - 1 = 0$$

$$\lim_{x \rightarrow 0} x = 0$$

so we have a $0/0$ indeterminate form.

- Set $f(x) = q^x - 1$ and $g(x) = x$, then (maybe after a quick review of Section 3.5)

$$f'(x) = \frac{d}{dx} (q^x - 1) = q^x \cdot \log q$$

$$g'(x) = 1$$

$$f'(0) = \log q$$

$$g'(0) = 1$$

- And by l'Hôpital's rule³

$$\lim_{h \rightarrow 0} \frac{q^h - 1}{h} = \log q.$$

Example 6.1.3

In this example, we shall apply L'Hôpital's rule twice before getting the answer.

Example 6.1.4

Compute the limit

$$\lim_{x \rightarrow 0} \frac{\sin(x^2)}{1 - \cos x}$$

- Again we should check

$$\begin{aligned} \lim_{x \rightarrow 0} \sin(x^2) &= \sin 0 = 0 \\ \lim_{x \rightarrow 0} (1 - \cos x) &= 1 - \cos 0 = 0 \end{aligned}$$

and we have a $0/0$ indeterminate form.

- Let $f(x) = \sin(x^2)$ and $g(x) = 1 - \cos x$ then

$$\begin{aligned} f'(x) &= 2x \cos(x^2) & f'(0) &= 0 \\ g'(x) &= \sin x & g'(0) &= 0 \end{aligned}$$

So if we try to apply l'Hôpital's rule naively we will get

$$\lim_{x \rightarrow 0} \frac{\sin(x^2)}{1 - \cos x} = \frac{f'(0)}{g'(0)} = \frac{0}{0}.$$

which is another $0/0$ indeterminate form.

- It appears that we are stuck until we remember that l'Hôpital's rule (as stated in Theorem 6.0.2) has a part (b) — now is a good time to reread it.

3 While it might not be immediately obvious, this example relies on circular reasoning. In order to apply l'Hôpital's rule, we need to compute the derivative of q^x . However in order to compute that limit (see Section 3.5) we needed to evaluate this limit.

A more obvious example of this sort of circular reasoning can be seen if we use l'Hôpital's rule to compute the derivative of $f(x) = x^n$ at $x = a$ using the limit

$$f'(a) = \lim_{x \rightarrow a} \frac{x^n - a^n}{x - a} = \lim_{x \rightarrow a} \frac{nx^{n-1} - 0}{1 - 0} = na^{n-1}.$$

We have used the result $\frac{d}{dx} x^n = nx^{n-1}$ to prove itself!

- It says that

$$\lim_{x \rightarrow 0} \frac{f(x)}{g(x)} = \lim_{x \rightarrow 0} \frac{f'(x)}{g'(x)}$$

provided this second limit exists. In our case this requires us to compute

$$\lim_{x \rightarrow 0} \frac{2x \cos(x^2)}{\sin(x)}$$

which we can do using l'Hôpital's rule again. Now

$$\begin{array}{lll} h(x) = 2x \cos(x^2) & h'(x) = 2 \cos(x^2) - 4x^2 \sin(x^2) & h'(0) = 2 \\ \ell(x) = \sin(x) & \ell'(x) = \cos(x) & \ell'(0) = 1 \end{array}$$

By l'Hôpital's rule

$$\lim_{x \rightarrow 0} \frac{2x \cos(x^2)}{\sin(x)} = \frac{h'(0)}{\ell'(0)} = 2$$

- Thus our original limit is

$$\lim_{x \rightarrow 0} \frac{\sin(x^2)}{1 - \cos x} = \lim_{x \rightarrow 0} \frac{2x \cos(x^2)}{\sin(x)} = 2.$$

- We can succinctly summarise the two applications of L'Hôpital's rule in this example by

$$\lim_{x \rightarrow 0} \underbrace{\frac{\sin(x^2)}{1 - \cos x}}_{\substack{\text{num} \rightarrow 0 \\ \text{den} \rightarrow 0}} = \lim_{x \rightarrow 0} \underbrace{\frac{2x \cos(x^2)}{\sin x}}_{\substack{\text{num} \rightarrow 0 \\ \text{den} \rightarrow 0}} = \lim_{x \rightarrow 0} \underbrace{\frac{2 \cos(x^2) - 4x^2 \sin(x^2)}{\cos x}}_{\substack{\text{num} \rightarrow 2 \\ \text{den} \rightarrow 1}} = 2$$

Here “num” and “den” are used as abbreviations of “numerator” and “denominator” respectively.”

Example 6.1.4

One must be careful to ensure that the hypotheses of l'Hôpital's rule are satisfied before applying it. The following “warnings” show the sorts of things that can go wrong.

Warning 6.1.5 (Denominator limit nonzero).

If

$$\lim_{x \rightarrow a} f(x) = 0 \quad \text{but} \quad \lim_{x \rightarrow a} g(x) \neq 0$$

then

$$\lim_{x \rightarrow a} \frac{f(x)}{g(x)} \quad \text{need not be the same as} \quad \frac{f'(a)}{g'(a)} \quad \text{or} \quad \lim_{x \rightarrow a} \frac{f'(x)}{g'(x)}.$$

Here is an example. Take

$$a = 0 \quad f(x) = 3x \quad g(x) = 4 + 5x$$

Then

$$\lim_{x \rightarrow 0} \frac{f(x)}{g(x)} = \lim_{x \rightarrow 0} \frac{3x}{4 + 5x} = \frac{3 \times 0}{4 + 5 \times 0} = 0$$

$$\lim_{x \rightarrow 0} \frac{f'(x)}{g'(x)} = \frac{f'(0)}{g'(0)} = \frac{3}{5}$$

Warning 6.1.6 (Numerator limit nonzero).

If

$$\lim_{x \rightarrow a} g(x) = 0 \quad \text{but} \quad \lim_{x \rightarrow a} f(x) \neq 0$$

then

$$\lim_{x \rightarrow a} \frac{f(x)}{g(x)} \quad \text{need not be the same as} \quad \lim_{x \rightarrow a} \frac{f'(x)}{g'(x)}.$$

Here is an example. Take

$$a = 0 \quad f(x) = 4 + 5x \quad g(x) = 3x$$

Then

$$\lim_{x \rightarrow 0} \frac{f(x)}{g(x)} = \lim_{x \rightarrow 0} \frac{4 + 5x}{3x} = \text{DNE}$$

$$\lim_{x \rightarrow 0} \frac{f'(x)}{g'(x)} = \lim_{x \rightarrow 0} \frac{5}{3} = \frac{5}{3}$$

This next one is more subtle; the limits of the original numerator and denominator functions both go to zero, but the limit of the ratio their derivatives does not exist.

Warning 6.1.7 (Limit of ratio of derivatives DNE).

If

$$\lim_{x \rightarrow a} f(x) = 0 \quad \text{and} \quad \lim_{x \rightarrow a} g(x) = 0$$

but

$$\lim_{x \rightarrow a} \frac{f'(x)}{g'(x)} \text{ does not exist}$$

then it is still possible that

$$\lim_{x \rightarrow a} \frac{f(x)}{g(x)} \text{ exists.}$$

Here is an example. Take

$$a = 0 \quad f(x) = x^2 \sin \frac{1}{x} \quad g(x) = x$$

Then (noting for $f(x)$ that $\sin \frac{1}{x}$ never gets very large, and x^2 approaches 0)

$$\lim_{x \rightarrow 0} f(x) = 0 \quad \text{and} \quad \lim_{x \rightarrow 0} g(x) = 0.$$

If we attempt to apply l'Hôpital's rule then we have $g'(x) = 1$ and

$$f'(x) = 2x \sin \frac{1}{x} - \cos \frac{1}{x}$$

and we then try to compute the limit

$$\lim_{x \rightarrow 0} \frac{f'(x)}{g'(x)} = \lim_{x \rightarrow 0} \left(2x \sin \frac{1}{x} - \cos \frac{1}{x} \right)$$

However, this limit does not exist. The first term converges to 0 (since $\sin \frac{1}{x}$ never gets very large, and it's multiplied by something approaching 0), but the second term $\cos(1/x)$ just oscillates wildly between ± 1 . All we can conclude from this is

Since the limit of the ratio of derivatives does not exist, we cannot apply l'Hôpital's rule.

Instead we should go back to the original limit:

$$\lim_{x \rightarrow 0} \frac{f(x)}{g(x)} = \lim_{x \rightarrow 0} \frac{x^2 \sin \frac{1}{x}}{x} = \lim_{x \rightarrow 0} x \sin \frac{1}{x} = 0,$$

since $|x \sin(1/x)| < |x|$ and $|x| \rightarrow 0$ as $x \rightarrow 0$.

It is also easy to construct an example in which the limits of numerator and denominator are

both zero, but the limit of the ratio and the limit of the ratio of the derivatives do not exist. A slight change of the previous example shows that it is possible that

$$\lim_{x \rightarrow a} f(x) = 0 \quad \text{and} \quad \lim_{x \rightarrow a} g(x) = 0$$

but neither of the limits

$$\lim_{x \rightarrow a} \frac{f(x)}{g(x)} \quad \text{or} \quad \lim_{x \rightarrow a} \frac{f'(x)}{g'(x)}$$

exist. Take

$$a = 0 \quad f(x) = x \sin \frac{1}{x} \quad g(x) = x$$

Then (noting $\sin \frac{1}{x}$ never gets very large, and it's multiplied by something going to 0)

$$\lim_{x \rightarrow 0} f(x) = 0 \quad \text{and} \quad \lim_{x \rightarrow 0} g(x) = 0.$$

However,

$$\lim_{x \rightarrow 0} \frac{f(x)}{g(x)} = \lim_{x \rightarrow 0} \frac{x \sin \frac{1}{x}}{x} = \lim_{x \rightarrow 0} \sin \frac{1}{x}$$

does not exist. And similarly

$$\lim_{x \rightarrow 0} \frac{f'(x)}{g'(x)} = \lim_{x \rightarrow 0} \frac{\sin \frac{1}{x} - \frac{1}{x} \cos \frac{1}{x}}{x^2}$$

does not exist.

6.2 ▲ Variations

Theorem 6.0.2 is the basic form of L'Hôpital's rule, but there are also many variations. Here are a bunch of them.

(a) L'Hôpital's rule also applies when the limit of $x \rightarrow a$ is replaced by $\lim_{x \rightarrow a+}$ or by $\lim_{x \rightarrow a-}$ or by $\lim_{x \rightarrow +\infty}$ or by $\lim_{x \rightarrow -\infty}$.

We can justify adapting the rule to the limits to $\pm\infty$ via the following reasoning

$$\begin{aligned} \lim_{x \rightarrow \infty} \frac{f(x)}{g(x)} &= \lim_{y \rightarrow 0^+} \frac{f(1/y)}{g(1/y)} && \text{substitute } x = 1/y \\ &= \lim_{y \rightarrow 0^+} \frac{-\frac{1}{y^2} f'(1/y)}{-\frac{1}{y^2} g'(1/y)}, \end{aligned}$$

where we have used l'Hôpital's rule (assuming this limit exists) and the fact that $\frac{d}{dy} f(1/y) = -\frac{1}{y^2} f'(1/y)$ (and similarly for g). Cleaning this up and substituting $y = 1/x$ gives the required result:

$$\lim_{x \rightarrow \infty} \frac{f(x)}{g(x)} = \lim_{y \rightarrow 0^+} \frac{f'(1/y)}{g'(1/y)} = \lim_{x \rightarrow \infty} \frac{f'(x)}{g'(x)}.$$

Example 6.2.1

Consider the limit

$$\lim_{x \rightarrow \infty} \frac{\arctan x - \frac{\pi}{2}}{1/x}$$

Both numerator and denominator go to 0 as $x \rightarrow \infty$, so this is an $0/0$ indeterminate form. We find

$$\lim_{x \rightarrow +\infty} \underbrace{\frac{\arctan x - \frac{\pi}{2}}{\frac{1}{x}}}_{\substack{\text{num} \rightarrow 0 \\ \text{den} \rightarrow 0}} = \lim_{x \rightarrow +\infty} \frac{\frac{1}{1+x^2}}{-\frac{1}{x^2}} = - \lim_{x \rightarrow +\infty} \underbrace{\frac{1}{1 + \frac{1}{x^2}}}_{\substack{\text{num} \rightarrow 1 \\ \text{den} \rightarrow 1}} = -1$$

We have applied L'Hôpital's rule with

$$\begin{aligned} f(x) &= \arctan x - \frac{\pi}{2} & g(x) &= \frac{1}{x} \\ f'(x) &= \frac{1}{1+x^2} & g'(x) &= -\frac{1}{x^2} \end{aligned}$$

Example 6.2.1

- (b) $\frac{\infty}{\infty}$ indeterminate form: L'Hôpital's rule also applies when $\lim_{x \rightarrow a} f(x) = 0$, $\lim_{x \rightarrow a} g(x) = 0$ is replaced by $\lim_{x \rightarrow a} f(x) = \pm\infty$, $\lim_{x \rightarrow a} g(x) = \pm\infty$.

Example 6.2.2

Consider the limit

$$\lim_{x \rightarrow \infty} \frac{\log x}{x}$$

The numerator and denominator both blow up towards infinity so this is an ∞/∞ indeterminate form. An application of L'Hôpital's rule gives

$$\begin{aligned} \lim_{x \rightarrow \infty} \underbrace{\frac{\log x}{x}}_{\substack{\text{num} \rightarrow \infty \\ \text{den} \rightarrow \infty}} &= \lim_{x \rightarrow \infty} \frac{1/x}{1} \\ &= \lim_{x \rightarrow \infty} \frac{1}{x} = 0 \end{aligned}$$

Example 6.2.2

Example 6.2.3

Consider the limit

$$\lim_{x \rightarrow \infty} \frac{5x^2 + 3x - 3}{x^2 + 1}$$

Then by two applications of l'Hôpital's rule we get

$$\lim_{x \rightarrow \infty} \underbrace{\frac{5x^2 + 3x - 3}{x^2 + 1}}_{\substack{\text{num} \rightarrow \infty \\ \text{den} \rightarrow \infty}} = \lim_{x \rightarrow \infty} \underbrace{\frac{10x + 3}{2x}}_{\substack{\text{num} \rightarrow \infty \\ \text{den} \rightarrow \infty}} = \lim_{x \rightarrow \infty} \frac{10}{2} = 5.$$

Example 6.2.3

Example 6.2.4

Compute the limit

$$\lim_{x \rightarrow 0^+} \frac{\log x}{\tan\left(\frac{\pi}{2} - x\right)}$$

We can compute this using l'Hôpital's rule twice:

$$\begin{aligned} \lim_{x \rightarrow 0^+} \underbrace{\frac{\log x}{\tan\left(\frac{\pi}{2} - x\right)}}_{\substack{\text{num} \rightarrow -\infty \\ \text{den} \rightarrow +\infty}} &= \lim_{x \rightarrow 0^+} \frac{\frac{1}{x}}{-\sec^2\left(\frac{\pi}{2} - x\right)} = - \lim_{x \rightarrow 0^+} \underbrace{\frac{\cos^2\left(\frac{\pi}{2} - x\right)}{x}}_{\substack{\text{num} \rightarrow 0 \\ \text{den} \rightarrow 0}} \\ &= - \lim_{x \rightarrow 0^+} \underbrace{\frac{2 \cos\left(\frac{\pi}{2} - x\right) \sin\left(\frac{\pi}{2} - x\right)}{1}}_{\substack{\text{num} \rightarrow 0 \\ \text{den} \rightarrow 1}} = 0 \end{aligned}$$

The first application of L'Hôpital's was with

$$\begin{aligned} f(x) &= \log x & g(x) &= \tan\left(\frac{\pi}{2} - x\right) \\ f'(x) &= \frac{1}{x} & g'(x) &= -\sec^2\left(\frac{\pi}{2} - x\right) \end{aligned}$$

and the second time with

$$\begin{aligned} f(x) &= \cos^2\left(\frac{\pi}{2} - x\right) & g(x) &= x \\ f'(x) &= 2 \cos\left(\frac{\pi}{2} - x\right) \left[-\sin\left(\frac{\pi}{2} - x\right)\right] (-1) & g'(x) &= 1 \end{aligned}$$

Example 6.2.4

Sometimes things don't quite work out as we would like and l'Hôpital's rule can get stuck in a loop. Remember to think about the problem before you apply any rule.

Example 6.2.5

Consider the limit

$$\lim_{x \rightarrow \infty} \frac{e^x + e^{-x}}{e^x - e^{-x}}$$

Clearly both numerator and denominator go to ∞ , so we have a ∞/∞ indeterminate form. Naively applying l'Hôpital's rule gives

$$\lim_{x \rightarrow \infty} \frac{e^x + e^{-x}}{e^x - e^{-x}} = \lim_{x \rightarrow \infty} \frac{e^x - e^{-x}}{e^x + e^{-x}}$$

which is again a ∞/∞ indeterminate form. So apply l'Hôpital's rule again:

$$\lim_{x \rightarrow \infty} \frac{e^x - e^{-x}}{e^x + e^{-x}} = \lim_{x \rightarrow \infty} \frac{e^x + e^{-x}}{e^x - e^{-x}}$$

which is right back where we started!

The correct approach to such a limit is to apply the methods we learned in Chapter 2 and rewrite

$$\frac{e^x + e^{-x}}{e^x - e^{-x}} = \frac{e^x(1 + e^{-2x})}{e^x(1 - e^{-2x})} = \frac{1 + e^{-2x}}{1 - e^{-2x}}$$

and then take the limit.

A similar sort of l'Hôpital-rule-loop will occur if you naively apply l'Hôpital's rule to the limit

$$\lim_{x \rightarrow \infty} \frac{\sqrt{4x^2 + 1}}{5x - 1}$$

which appeared in Example 2.1.33.

Example 6.2.5

- (c) $0 \cdot \infty$ indeterminate form: When $\lim_{x \rightarrow a} f(x) = 0$ and $\lim_{x \rightarrow a} g(x) = \infty$. We can use a little algebra to manipulate this into either a $\frac{0}{0}$ or $\frac{\infty}{\infty}$ form:

$$\lim_{x \rightarrow a} \frac{f(x)}{1/g(x)} \qquad \lim_{x \rightarrow a} \frac{g(x)}{1/f(x)}$$

Example 6.2.6

Consider the limit

$$\lim_{x \rightarrow 0^+} x \cdot \log x$$

Here the function $f(x) = x$ goes to zero, while $g(x) = \log x$ goes to $-\infty$. If we rewrite this as the fraction

$$x \cdot \log x = \frac{\log x}{1/x}$$

then the $0 \cdot \infty$ form has become an ∞/∞ form.

The result is then

$$\lim_{x \rightarrow 0^+} \underbrace{x}_{\rightarrow 0} \underbrace{\log x}_{\rightarrow -\infty} = \lim_{x \rightarrow 0^+} \underbrace{\frac{\log x}{\frac{1}{x}}}_{\substack{\text{num} \rightarrow -\infty \\ \text{den} \rightarrow \infty}} = \lim_{x \rightarrow 0^+} \frac{1}{-\frac{1}{x^2}} = - \lim_{x \rightarrow 0^+} x = 0$$

Example 6.2.6

Example 6.2.7

In this example we'll evaluate $\lim_{x \rightarrow +\infty} x^n e^{-x}$, for all natural numbers n . We'll start with $n = 1$ and $n = 2$ and then, using what we have learned from those cases, move on to general n .

$$\lim_{x \rightarrow +\infty} \underbrace{x}_{\rightarrow \infty} \underbrace{e^{-x}}_{\rightarrow 0} = \lim_{x \rightarrow +\infty} \underbrace{\frac{x}{e^x}}_{\substack{\text{num} \rightarrow +\infty \\ \text{den} \rightarrow +\infty}} = \lim_{x \rightarrow +\infty} \underbrace{\frac{1}{e^x}}_{\substack{\text{num} \rightarrow 1 \\ \text{den} \rightarrow +\infty}} = \lim_{x \rightarrow +\infty} e^{-x} = 0$$

Applying l'Hôpital twice,

$$\lim_{x \rightarrow +\infty} \underbrace{x^2}_{\rightarrow \infty} \underbrace{e^{-x}}_{\rightarrow 0} = \lim_{x \rightarrow +\infty} \underbrace{\frac{x^2}{e^x}}_{\substack{\text{num} \rightarrow +\infty \\ \text{den} \rightarrow +\infty}} = \lim_{x \rightarrow +\infty} \underbrace{\frac{2x}{e^x}}_{\substack{\text{num} \rightarrow \infty \\ \text{den} \rightarrow +\infty}} = \lim_{x \rightarrow +\infty} \underbrace{\frac{2}{e^x}}_{\substack{\text{num} \rightarrow 2 \\ \text{den} \rightarrow +\infty}} = \lim_{x \rightarrow +\infty} 2e^{-x} = 0$$

Indeed, for any natural number n , applying l'Hôpital n times gives

$$\begin{aligned} \lim_{x \rightarrow +\infty} \underbrace{x^n}_{\rightarrow \infty} \underbrace{e^{-x}}_{\rightarrow 0} &= \lim_{x \rightarrow +\infty} \underbrace{\frac{x^n}{e^x}}_{\substack{\text{num} \rightarrow +\infty \\ \text{den} \rightarrow +\infty}} \\ &= \lim_{x \rightarrow +\infty} \underbrace{\frac{nx^{n-1}}{e^x}}_{\substack{\text{num} \rightarrow \infty \\ \text{den} \rightarrow +\infty}} \\ &= \lim_{x \rightarrow +\infty} \underbrace{\frac{n(n-1)x^{n-2}}{e^x}}_{\substack{\text{num} \rightarrow \infty \\ \text{den} \rightarrow +\infty}} \\ &= \dots = \lim_{x \rightarrow +\infty} \underbrace{\frac{n!}{e^x}}_{\substack{\text{num} \rightarrow n! \\ \text{den} \rightarrow +\infty}} = 0 \end{aligned}$$

Example 6.2.7

6.3 ▲ (optional) Even more variations

These next forms aren't explicitly part of the learning goals, but they're a good opportunity to practice algebra skills, such as those used in logarithmic differentiation.

- (d) $\infty - \infty$ indeterminate form: When $\lim_{x \rightarrow a} f(x) = \infty$ and $\lim_{x \rightarrow a} g(x) = \infty$. We rewrite the difference as a fraction using a common denominator

$$f(x) - g(x) = \frac{h(x)}{\ell(x)}$$

which is then a $0/0$ or ∞/∞ form.

Example 6.3.1

Consider the limit

$$\lim_{x \rightarrow \frac{\pi}{2}^-} (\sec x - \tan x)$$

Since the limit of both $\sec x$ and $\tan x$ is $+\infty$ as $x \rightarrow \frac{\pi}{2}^-$, this is an $\infty - \infty$ indeterminate form. However we can rewrite this as

$$\sec x - \tan x = \frac{1}{\cos x} - \frac{\sin x}{\cos x} = \frac{1 - \sin x}{\cos x}$$

which is then a $0/0$ indeterminate form. This then gives

$$\lim_{x \rightarrow \frac{\pi}{2}^-} \left(\underbrace{\sec x}_{\rightarrow +\infty} - \underbrace{\tan x}_{\rightarrow +\infty} \right) = \lim_{x \rightarrow \frac{\pi}{2}^-} \frac{1 - \sin x}{\cos x} = \lim_{x \rightarrow \frac{\pi}{2}^-} \frac{\underbrace{-\cos x}_{\text{num} \rightarrow 0}}{\underbrace{-\sin x}_{\text{den} \rightarrow -1}} = 0$$

Example 6.3.1

In the last example, Example 6.3.1, we converted an $\infty - \infty$ indeterminate form into a $\frac{0}{0}$ indeterminate form by exploiting the fact that the two terms, $\sec x$ and $\tan x$, in the $\infty - \infty$ indeterminate form shared a common denominator, namely $\cos x$. In the "real world" that will, of course, almost never happen. However as the next couple of examples show, you can often massage these expressions into suitable forms.

Here is another, much more complicated, example, where it doesn't happen.

Example 6.3.2

In this example, we evaluate the $\infty - \infty$ indeterminate form

$$\lim_{x \rightarrow 0} \left(\underbrace{\frac{1}{x}}_{\rightarrow \pm\infty} - \underbrace{\frac{1}{\log(1+x)}}_{\rightarrow \pm\infty} \right)$$

We convert it into a $\frac{0}{0}$ indeterminate form simply by putting the two fractions, $\frac{1}{x}$ and $\frac{1}{\log(1+x)}$ over a common denominator.

$$\lim_{x \rightarrow 0} \left(\underbrace{\frac{1}{x}}_{\rightarrow \pm\infty} - \underbrace{\frac{1}{\log(1+x)}}_{\rightarrow \pm\infty} \right) = \lim_{x \rightarrow 0} \underbrace{\frac{\log(1+x) - x}{x \log(1+x)}}_{\substack{\text{num} \rightarrow 0 \\ \text{den} \rightarrow 0}} \tag{E1}$$

Now we apply L'Hôpital's rule, and simplify

$$\begin{aligned} \lim_{x \rightarrow 0} \underbrace{\frac{\log(1+x) - x}{x \log(1+x)}}_{\substack{\text{num} \rightarrow 0 \\ \text{den} \rightarrow 0}} &= \lim_{x \rightarrow 0} \frac{\frac{1}{1+x} - 1}{\log(1+x) + \frac{x}{1+x}} = \lim_{x \rightarrow 0} \frac{1 - (1+x)}{(1+x) \log(1+x) + x} \\ &= - \lim_{x \rightarrow 0} \underbrace{\frac{x}{(1+x) \log(1+x) + x}}_{\substack{\text{num} \rightarrow 0 \\ \text{den} \rightarrow 1 \times 0 + 0 = 0}} \end{aligned} \tag{E2}$$

Then we apply L'Hôpital's rule a second time

$$- \lim_{x \rightarrow 0} \underbrace{\frac{x}{(1+x) \log(1+x) + x}}_{\substack{\text{num} \rightarrow 0 \\ \text{den} \rightarrow 1 \times 0 + 0 = 0}} = - \lim_{x \rightarrow 0} \underbrace{\frac{1}{\log(1+x) + \frac{1+x}{1+x} + 1}}_{\substack{\text{num} \rightarrow 1 \\ \text{den} \rightarrow 0 + 1 + 1 = 2}} = -\frac{1}{2} \tag{E3}$$

Combining (E1), (E2) and (E3) gives our final answer

$$\lim_{x \rightarrow 0} \left(\frac{1}{x} - \frac{1}{\log(1+x)} \right) = -\frac{1}{2}$$

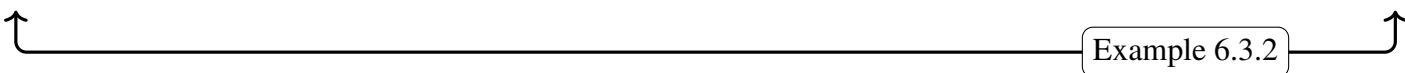

The following example can be done by l'Hôpital's rule, but it is actually far simpler to multiply by the conjugate and take the limit using the tools of Chapter 2.

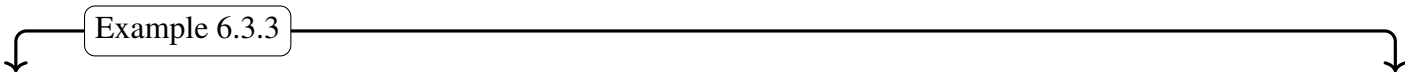

Consider the limit

$$\lim_{x \rightarrow \infty} \sqrt{x^2 + 4x} - \sqrt{x^2 - 3x}$$

Neither term is a fraction, but we can write

$$\begin{aligned} \sqrt{x^2 + 4x} - \sqrt{x^2 - 3x} &= x\sqrt{1 + 4/x} - x\sqrt{1 - 3/x} && \text{assuming } x > 0 \\ &= x \left(\sqrt{1 + 4/x} - \sqrt{1 - 3/x} \right) \\ &= \frac{\sqrt{1 + 4/x} - \sqrt{1 - 3/x}}{1/x} \end{aligned}$$

which is now a $0/0$ form with $f(x) = \sqrt{1+4/x} - \sqrt{1-3/x}$ and $g(x) = 1/x$. Then

$$f'(x) = \frac{-4/x^2}{2\sqrt{1+4/x}} - \frac{3/x^2}{2\sqrt{1-3/x}} \qquad g'(x) = -\frac{1}{x^2}$$

Hence

$$\frac{f'(x)}{g'(x)} = \frac{4}{2\sqrt{1+4/x}} + \frac{3}{2\sqrt{1-3/x}}$$

And so in the limit as $x \rightarrow \infty$

$$\lim_{x \rightarrow \infty} \frac{f'(x)}{g'(x)} = \frac{4}{2} + \frac{3}{2} = \frac{7}{2}$$

and so our original limit is also $7/2$.

By comparison, if we multiply by the conjugate we have

$$\begin{aligned} \sqrt{x^2+4x} - \sqrt{x^2-3x} &= \left(\sqrt{x^2+4x} - \sqrt{x^2-3x}\right) \cdot \frac{\sqrt{x^2+4x} + \sqrt{x^2-3x}}{\sqrt{x^2+4x} + \sqrt{x^2-3x}} \\ &= \frac{x^2+4x - (x^2-3x)}{\sqrt{x^2+4x} + \sqrt{x^2-3x}} \\ &= \frac{7x}{\sqrt{x^2+4x} + \sqrt{x^2-3x}} \\ &= \frac{7}{\sqrt{1+4/x} + \sqrt{1-3/x}} \qquad \text{assuming } x > 0 \end{aligned}$$

Now taking the limit as $x \rightarrow \infty$ gives $7/2$ as required. Just because we know l'Hôpital's rule, it does not mean we should use it everywhere it might be applied.

Example 6.3.3

(e) 1^∞ indeterminate form: We can use l'Hôpital's rule on limits of the form

$$\lim_{x \rightarrow a} f(x)^{g(x)} \text{ with } \lim_{x \rightarrow a} f(x) = 1 \qquad \text{and} \qquad \lim_{x \rightarrow a} g(x) = \infty$$

by considering the logarithm of the limit⁴:

$$\log \left(\lim_{x \rightarrow a} f(x)^{g(x)} \right) = \lim_{x \rightarrow a} \log \left(f(x)^{g(x)} \right) = \lim_{x \rightarrow a} \log(f(x)) \cdot g(x)$$

which is now an $0 \cdot \infty$ form. This can be further transformed into a $0/0$ or ∞/∞ form:

$$\begin{aligned} \log \left(\lim_{x \rightarrow a} f(x)^{g(x)} \right) &= \lim_{x \rightarrow a} \log(f(x)) \cdot g(x) \\ &= \lim_{x \rightarrow a} \frac{\log(f(x))}{1/g(x)}. \end{aligned}$$

4 We are using the fact that the logarithm is a continuous function and Theorem 2.3.8.

Example 6.3.4

The following limit appears quite naturally when considering systems which display exponential growth or decay.

$$\lim_{x \rightarrow 0} (1+x)^{a/x} \quad \text{with the constant } a \neq 0$$

Since $(1+x) \rightarrow 1$ and $a/x \rightarrow \infty$ this is an 1^∞ indeterminate form.

By considering its logarithm we have

$$\begin{aligned} \log \left(\lim_{x \rightarrow 0} (1+x)^{a/x} \right) &= \lim_{x \rightarrow 0} \log \left((1+x)^{a/x} \right) \\ &= \lim_{x \rightarrow 0} \frac{a}{x} \log(1+x) \\ &= \lim_{x \rightarrow 0} \frac{a \log(1+x)}{x} \end{aligned}$$

which is now a $0/0$ form. Applying l'Hôpital's rule gives

$$\lim_{x \rightarrow 0} \underbrace{\frac{a \log(1+x)}{x}}_{\substack{\text{num} \rightarrow 0 \\ \text{den} \rightarrow 0}} = \lim_{x \rightarrow 0} \underbrace{\frac{\frac{a}{1+x}}{1}}_{\substack{\text{num} \rightarrow a \\ \text{den} \rightarrow 1}} = a$$

Since $(1+x)^{a/x} = \exp \left[\log \left((1+x)^{a/x} \right) \right]$ and the exponential function is continuous, our original limit is e^a .

Example 6.3.4

Here is a more complicated example of a 1^∞ indeterminate form.

Example 6.3.5

In the limit

$$\lim_{x \rightarrow 0} \left(\frac{\sin x}{x} \right)^{1/x^2}$$

the base, $\frac{\sin x}{x}$, converges to 1 (see Example 6.1.1) and the exponent, $\frac{1}{x^2}$, goes to ∞ . But if we take logarithms then

$$\log \left(\frac{\sin x}{x} \right)^{1/x^2} = \frac{\log \frac{\sin x}{x}}{x^2}$$

then, in the limit $x \rightarrow 0$, we have a $0/0$ indeterminate form. One application of l'Hôpital's rule gives

$$\lim_{x \rightarrow 0} \underbrace{\frac{\log \frac{\sin x}{x}}{x^2}}_{\substack{\text{num} \rightarrow 0 \\ \text{den} \rightarrow 0}} = \lim_{x \rightarrow 0} \frac{\frac{x}{\sin x} \cdot \frac{x \cos x - \sin x}{x^2}}{2x} = \lim_{x \rightarrow 0} \frac{\frac{x \cos x - \sin x}{x \sin x}}{2x} = \lim_{x \rightarrow 0} \frac{x \cos x - \sin x}{2x^2 \sin x}$$

which is another $0/0$ form. Applying l'Hôpital's rule again gives:

$$\begin{aligned} \lim_{x \rightarrow 0} \frac{x \cos x - \sin x}{2x^2 \sin x} &= \lim_{x \rightarrow 0} \frac{\cos x - x \sin x - \cos x}{4x \sin x + 2x^2 \cos x} \\ &= - \lim_{x \rightarrow 0} \frac{x \sin x}{4x \sin x + 2x^2 \cos x} = - \lim_{x \rightarrow 0} \frac{\sin x}{4 \sin x + 2x \cos x} \end{aligned}$$

which is yet another $0/0$ form. Once more with l'Hôpital's rule:

$$\begin{aligned} - \lim_{x \rightarrow 0} \frac{\sin x}{4 \sin x + 2x \cos x} &= - \lim_{x \rightarrow 0} \frac{\cos x}{4 \cos x + 2 \cos x - 2x \sin x} \\ &= - \frac{1}{6} \end{aligned}$$

Oof! We have just shown that the logarithm of our original limit is $-1/6$. Hence the original limit itself is $e^{-1/6}$.

This was quite a complicated example. However it does illustrate the importance of cleaning up your algebraic expressions. This will both reduce the amount of work you have to do and will also reduce the number of errors you make.

Example 6.3.5

(f) 0^0 indeterminate form: Like the 1^∞ form, this can be treated by considering its logarithm.

Example 6.3.6

For example, in the limit

$$\lim_{x \rightarrow 0^+} x^x$$

both the base, x , and the exponent, also x , go to zero. But if we consider the logarithm then we have

$$\log x^x = x \log x$$

which is a $0 \cdot \infty$ indeterminate form, which we already know how to treat. In fact, we already found, in Example 6.2.6, that

$$\lim_{x \rightarrow 0^+} x \log x = 0$$

Since the exponential is a continuous function

$$\lim_{x \rightarrow 0^+} x^x = \lim_{x \rightarrow 0^+} \exp(x \log x) = \exp\left(\lim_{x \rightarrow 0^+} x \log x\right) = e^0 = 1$$

Example 6.3.6

(g) ∞^0 *indeterminate form*: Again, we can treat this form by considering its logarithm.

Example 6.3.7

For example, in the limit

$$\lim_{x \rightarrow +\infty} x^{1/x}$$

the base, x , goes to infinity and the exponent, $\frac{1}{x}$, goes to zero. But if we take logarithms

$$\log x^{1/x} = \frac{\log x}{x}$$

which is an ∞/∞ form, which we know how to treat.

$$\lim_{x \rightarrow +\infty} \underbrace{\frac{\log x}{x}}_{\substack{\text{num} \rightarrow \infty \\ \text{den} \rightarrow \infty}} = \lim_{x \rightarrow +\infty} \underbrace{\frac{\frac{1}{x}}{1}}_{\substack{\text{num} \rightarrow 0 \\ \text{den} \rightarrow 1}} = 0$$

Since the exponential is a continuous function

$$\lim_{x \rightarrow +\infty} x^{1/x} = \lim_{x \rightarrow +\infty} \exp\left(\frac{\log x}{x}\right) = \exp\left(\lim_{x \rightarrow \infty} \frac{\log x}{x}\right) = e^0 = 1$$

Example 6.3.7

SKETCHING GRAPHS

One of the most obvious applications of derivatives is to help us understand the shape of the graph of a function. In this section we will use our accumulated knowledge of derivatives to identify the most important qualitative features of graphs $y = f(x)$. The goal of this section is to highlight features of the graph $y = f(x)$ that are easily

- determined from $f(x)$ itself, and
- deduced from $f'(x)$, and
- read from $f''(x)$.

We will then use the ideas to sketch several examples.

7.1 ▲ Domain, intercepts and asymptotes

Learning Objectives

- Sketch a function using information from precalculus (limits, intercepts) and its asymptotic behaviour.
- Efficiently find signs of factored functions (by determining where the signs change, or using another method).

Given a function $f(x)$, there are several important features that we can determine from that expression before examining its derivatives.

- The domain of the function — take note of values where f does not exist. If the function is rational, look for where the denominator is zero. Similarly be careful to look for roots of negative numbers or other possible sources of discontinuities.
- Intercepts — examine where the function crosses the x -axis and the y -axis by solving $f(x) = 0$ and computing $f(0)$.

- Vertical asymptotes — look for values of x at which $f(x)$ blows up. If $f(x)$ approaches either $+\infty$ or $-\infty$ as x approaches a (or possibly as x approaches a from one side) then $x = a$ is a vertical asymptote to $y = f(x)$. When $f(x)$ is a rational function (written so that common factors are cancelled), then $y = f(x)$ has vertical asymptotes at the zeroes of the denominator.
- Horizontal asymptotes — examine the limits of $f(x)$ as $x \rightarrow +\infty$ and $x \rightarrow -\infty$. Often $f(x)$ will tend to $+\infty$ or to $-\infty$ or to a finite limit L . If, for example, $\lim_{x \rightarrow +\infty} f(x) = L$, then $y = L$ is a horizontal asymptote to $y = f(x)$ as $x \rightarrow \infty$.
- Asymptotic behaviour – check to see whether $f(x)$ will closely resemble a function whose shape you already know (such as a power function or an exponential function) for certain values of x (usually x close to the origin, x large and positive, or x large and negative).

Example 7.1.1

Consider the function

$$f(x) = \frac{x+1}{(x+3)(x-2)}$$

- We see that it is defined on all real numbers except $x = -3, +2$.
- Since $f(0) = -1/6$ and $f(x) = 0$ only when $x = -1$, the graph has y -intercept $(0, -1/6)$ and x -intercept $(-1, 0)$.
- Since the function is rational and its denominator is zero at $x = -3, +2$ it will have vertical asymptotes at $x = -3, +2$. To determine the shape around those asymptotes we need to examine the limits

$$\lim_{x \rightarrow -3} f(x) \qquad \lim_{x \rightarrow 2} f(x)$$

Notice that when x is close to -3 , the factors $(x+1)$ and $(x-2)$ are both negative, so the sign of $f(x) = \frac{x+1}{x-2} \cdot \frac{1}{x+3}$ is the same as the sign of $x+3$. Hence

$$\lim_{x \rightarrow -3^+} f(x) = +\infty \qquad \lim_{x \rightarrow -3^-} f(x) = -\infty$$

A similar analysis when x is near 2 gives

$$\lim_{x \rightarrow 2^+} f(x) = +\infty \qquad \lim_{x \rightarrow 2^-} f(x) = -\infty$$

- Finally since the numerator has degree 1 and the denominator has degree 2, we see that as $x \rightarrow \pm\infty$, $f(x) \rightarrow 0$. So $y = 0$ is a horizontal asymptote.
- Since we know the behaviour around the asymptotes and we know the locations of the intercepts (as shown in the left graph below), we can then join up the pieces and smooth them out to get the a good sketch of this function (below right).

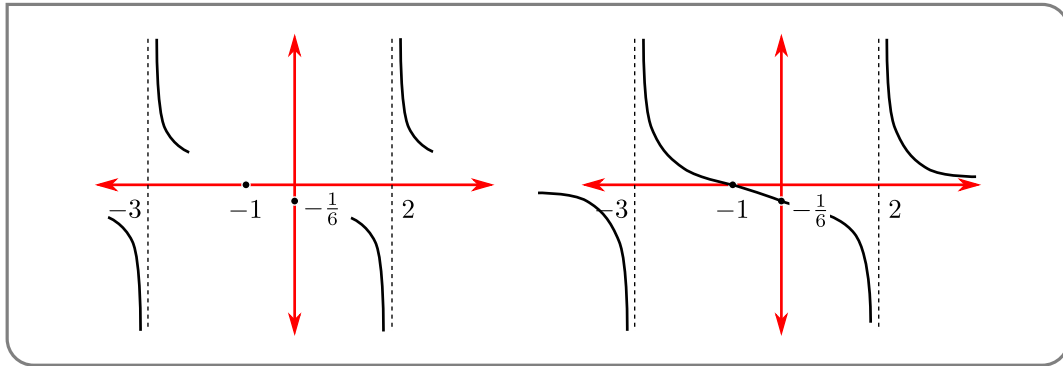

Example 7.1.1

►► Signs of Factored Functions

At about this point in your sketching journey, you'll find yourself making lots of tables that show where a function is positive, negative, and zero. Below, we'll outline a method for doing this pretty quickly (and mostly in your head) when the function is in factored form. You should know some way of finding the signs of a function, but it doesn't have to be this way.

Functions can only change signs where they are 0 or discontinuous, so finding where a function is zero or discontinuous is the first step. This separates the real line into sub-intervals where you're sure the function will have a single sign. The next step is to figure out what the sign is on those intervals.

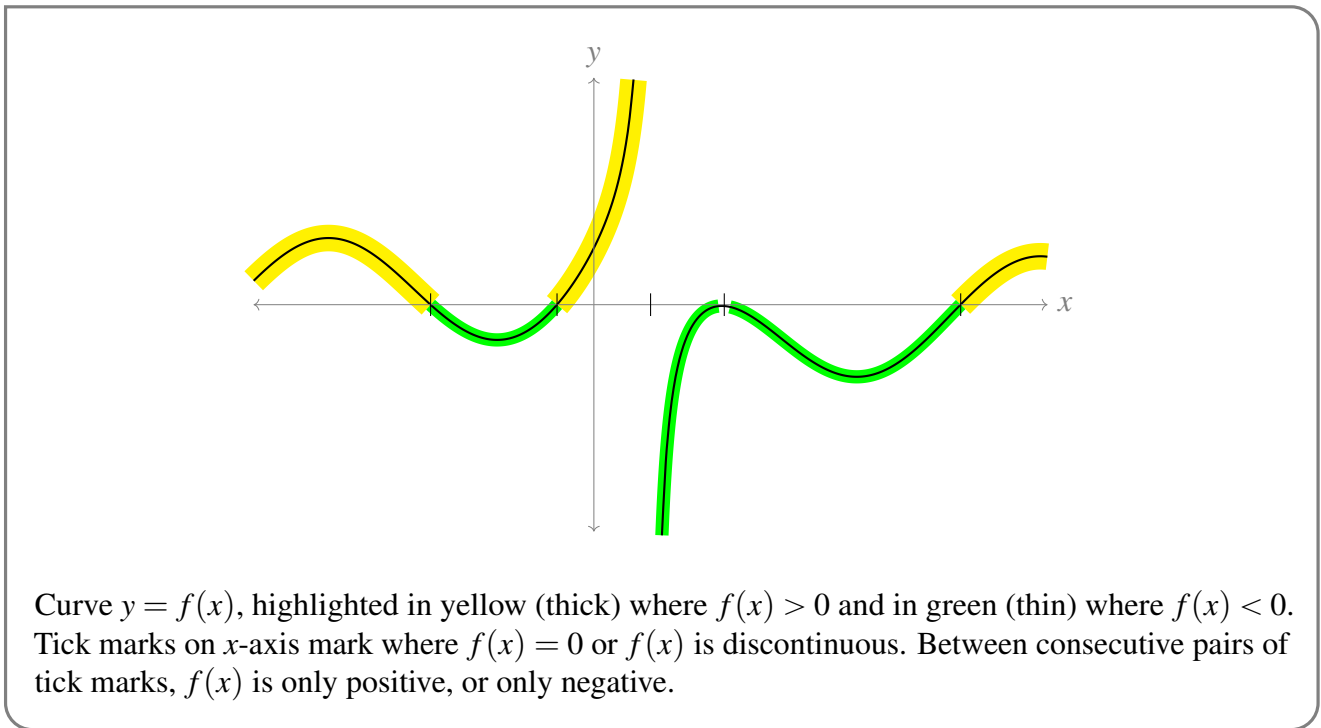

In high school, you might have learned to determine the sign over an interval by plugging in a test point. A method that is frequently quicker and easier is to find the sign in *only one* interval, and

determine whether or not the function's sign *changes* at the boundaries of its other intervals. We'll go through one example of this in gory detail to illustrate the procedure, but note most of what we are writing down can be done in your head.

For example, let's say we want to know when the function

$$f(x) = \frac{e^x(x-3)(x-4)^2(x-5)^3}{(x+1)^4(x+2)^5}$$

is positive, and where it is negative. The function has roots at $x = 3$, $x = 4$, and $x = 5$; the function is undefined (therefore not continuous) at $x = -1$ and $x = -2$. So, our broken-up real number line looks like this:

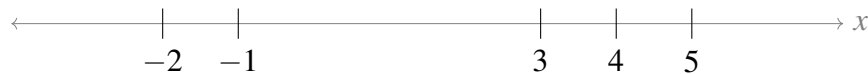

Testing points would be tedious – not only are there a large number to test, but they're close together, so we'd be plugging in non-integer values. Instead, we'll think about whether or not $f(x)$ changes signs at each of the tick marks above.

$x = 3$: When x is near 3, all the factors *except* $(x - 3)$ are far from 0.

- Any factor *other than* $(x - 3)$ has the same sign for values of x slightly less than 3, and for values of x slightly more than 3. For example: the factor $x + 1$ is positive for both $x = 2.9$ and $x = 3.1$; the factor $x - 5$ is negative both for $x = 2.9$ and for $x = 3.1$.
- However, if x is even a tiny bit less than 3, then $(x - 3)$ is negative; and if x is even a tiny bit more than 3, $(x - 3)$ is positive. So we think of this factor as *changing signs* at $x = 3$.
- All together:
 - If x is just slightly to the left of 3 on our numberline, our signs are:

$$f(x) = \underbrace{\frac{e^x(x-4)^2(x-5)^3}{(x+1)^4(x+2)^5}}_{\text{something}} \cdot \underbrace{(x-3)}_{-}$$

- If x is just slightly to the right of 3 on our numberline, our signs are:

$$f(x) = \underbrace{\frac{e^x(x-4)^2(x-5)^3}{(x+1)^4(x+2)^5}}_{\text{something}} \cdot \underbrace{(x-3)}_{+}$$

where “something” is the same sign in both cases.

So, **the sign of $f(x)$ will change at $x = 3$.**

$x = 4$: When x is near 4, all the factors *except* $(x - 4)$ are far from 0.

- Any factor *other than* $(x - 4)$ has the same sign for values of x slightly less than 4, and for values of x slightly more than 4.
- For x slightly less than 4, and x slightly more than 4, the term $(x - 4)^2$ also has the same sign (since it's squared).

- All together:
 - If x is just slightly to the left of 4 on our numberline, our signs are:

$$f(x) = \underbrace{\frac{e^x(x-3)(x-5)^3}{(x+1)^4(x+2)^5}}_{\text{something}} \cdot \underbrace{(x-4)^2}_{+}.$$

- If x is just slightly to the right of 4 on our numberline, our signs are:

$$f(x) = \underbrace{\frac{e^x(x-3)(x-5)^3}{(x+1)^4(x+2)^5}}_{\text{something}} \cdot \underbrace{(x-4)^2}_{+}$$

where “something” is the same sign in both cases.

So, the sign of $f(x)$ will not change at $x = 4$.

By now, you might have noticed the key pattern: if there are an odd number of factors that change signs at a point, then the sign of $f(x)$ will change at that point; if there are an even number of factors that change signs at a point, then the sign of $f(x)$ will not change at that point.

$x = 5$: The term $(x-5)^3$ changes signs at $x = 5$ (it's positive for $x > 5$, and negative for $x < 5$). No other parts of $f(x)$ change signs at $x = 5$. So, the sign of $f(x)$ will change at $x = 5$.

$x = -1$: The term $(x+1)^4$ does not change signs at $x = -1$ (it's positive for both $x > -1$ and $x < -1$). No other parts of $f(x)$ change signs at $x = -1$. So, the sign of $f(x)$ will not change at $x = -1$.

$x = -2$: The term $(x+2)^5$ changes signs at $x = -2$ (it's positive for $x > -2$, and negative for $x < -2$). No other parts of $f(x)$ change signs at $x = -2$. So, the sign of $f(x)$ will change at $x = -2$.

Let's add these insights into our number line.

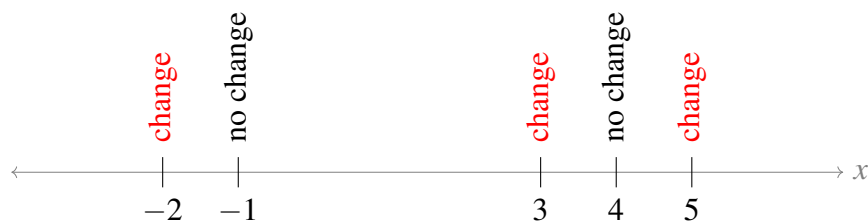

Now we just need to find the sign of $f(x)$ in one interval, and the rest will fall like dominoes. Usually the unbounded intervals (x very large and positive, or x very large and negative) are the easiest to do in your head. So, let's start with the rightmost interval: imagine a value of x that is larger than 5.

- If $x > 5$, then every single factor of $f(x)$ is positive, so $f(x) > 0$.

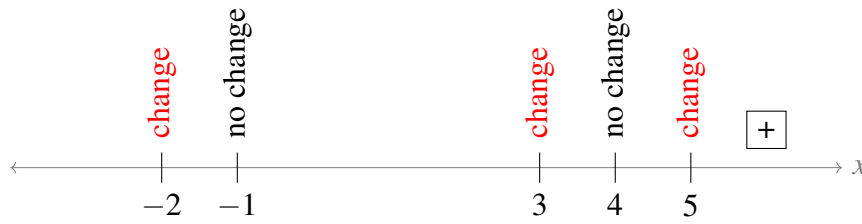

- The sign of $f(x)$ changes at $x = 5$, so $f(x) < 0$ when $4 < x < 5$.

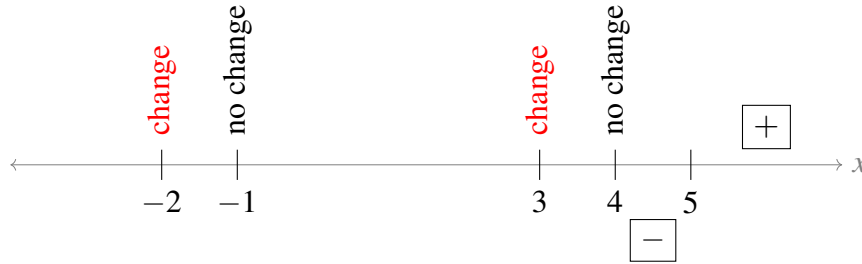

- The sign of $f(x)$ does not change at $x = 4$, so $f(x) < 0$ when $3 < x < 4$.

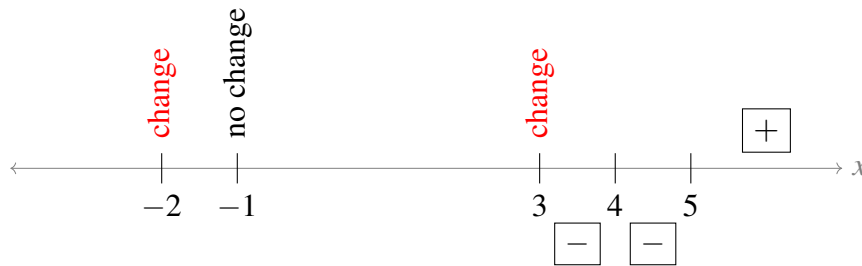

- The sign of $f(x)$ changes at $x = 3$, so $f(x) > 0$ when $-1 < x < 3$.

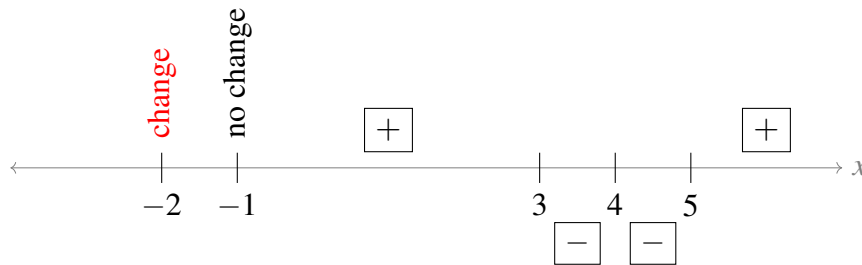

- The sign of $f(x)$ does not change at $x = -1$, so $f(x) > 0$ when $-2 < x < -1$.

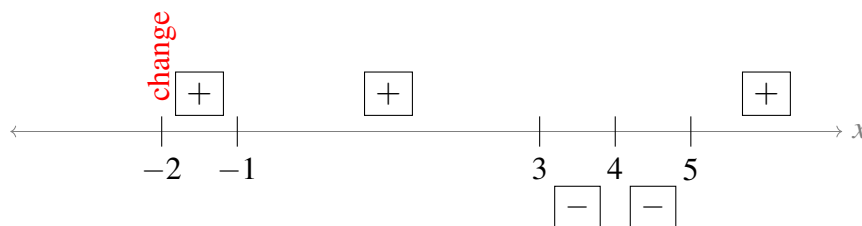

- The sign of $f(x)$ changes at $x = -2$, so $f(x) < 0$ when $x < -2$.

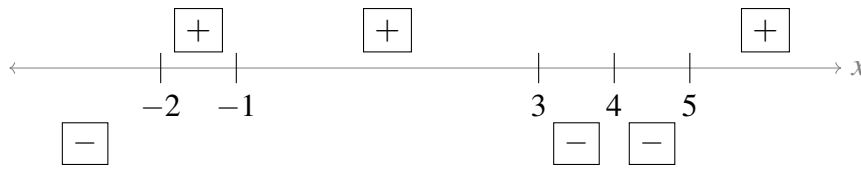

All together, $f(x)$ is positive on $(-2, -1) \cup (-1, 3) \cup (5, \infty)$ and negative on $(-\infty, -2) \cup (3, 4) \cup (4, 5)$.

That's a lot to write out, but once you get the idea, it goes pretty quickly, and you can do most of it in your head.

Example 7.1.2

Determine where

$$f(x) = (x - 1.1)(x - 1.2)(x - 1.3)^2$$

is positive and where it is negative.

- We divide up the real line with tick marks at the roots of $f(x)$: $x = 1.1$, $x = 1.2$, and $x = 1.3$.
- From the parity (evenness/oddness) of the factors, we see that $f(x)$ will change its sign at $x = 1.1$ and $x = 1.2$, and it will not change its sign at $x = 1.3$. We mark this on a number line.

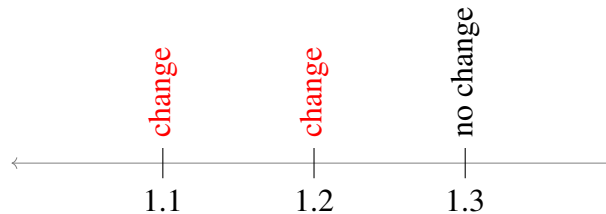

- For large x (specifically, $x > 1.3$), all factors of $f(x)$ are positive, so $f(x)$ is positive. We add this to our numberline, then fill in the rest of the intervals by deciding whether or not the sign of $f(x)$ changes at the points of interest.

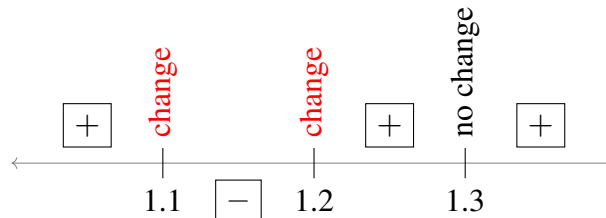

So, $f(x)$ is positive for x in $(-\infty, 1.1) \cup (1.2, 1.3) \cup (1.3, \infty)$ and it is negative for x in $(1.1, 1.2)$.

Example 7.1.2

7.2 ▲ First derivative — increasing or decreasing

Learning Objectives

- Determine where a graph is increasing or decreasing based on the signs of its first derivative. Represent this behaviour in a sketch.

Now we move on to the first derivative, $f'(x)$. Consider any function $f(x)$ that is continuous on an interval $A \leq x \leq B$ and is differentiable on $A < x < B$. Then

- if $f'(x) > 0$ for all $A < x < B$, then $f(x)$ is increasing on (A, B) — that is, for all $A < a < b < B$, $f(a) < f(b)$.
- if $f'(x) < 0$ for all $A < x < B$, then $f(x)$ is decreasing on (A, B) — that is, for all $A < a < b < B$, $f(a) > f(b)$.

Thus the sign of the derivative indicates to us whether the function is increasing or decreasing. Further, we should also examine points at which the derivative is zero — called *critical points* — and points where the derivative does not exist — called *singular points*. These points may indicate a local maximum (high point) or minimum¹ (low point).

Definition 7.2.1.

Consider a function $f(x)$ that is defined on an interval I , *except possibly* at finitely many points of I .

- If $f'(a) = 0$, then we call a a *critical point* of f .
- If f or its derivative f' is not defined at a point a of I , then we call a a *singular point* of f .

Informally: critical points are where the value of a function's derivative is 0; singular points are where a function's derivative isn't defined.

Warning 7.2.2.

Note that some people (and texts) will combine both of these cases and call $x = c$ a critical point when either the derivative is zero or does not exist. Some people (and texts) also require that the function exists at a point for that point to be eligible for critical/singular status. Further, in some texts, “critical point” and “singular point” may refer to the points in space (e.g. the point (x, y)), and the function's input may be called a “critical number” or “singular number.”

The reader should be aware of the lack of convention on this point² and should be careful to understand whether the more inclusive definition of critical point is being used, or if the text is using the more precise definition that distinguishes critical and singular points.

¹ We'll think a lot more about local maxima and minima in Chapter 8. Definition 8.1.2 gives details.

After studying the function $f(x)$ as described in Section 7.1, we should compute its derivative $f'(x)$. Then, we can learn the following:

- Critical points — determine where $f'(x) = 0$. At a critical point, f has a horizontal tangent.
- Singular points — determine where $f'(x)$ is not defined. If $f'(x)$ approaches $\pm\infty$ as x approaches a singular point a , then f has a vertical tangent there when f approaches a finite value as x approaches a (or possibly approaches a from one side) and a vertical asymptote when $f(x)$ approaches $\pm\infty$ as x approaches a (or possibly approaches a from one side).
- Increasing and decreasing — where is the derivative positive and where is it negative. Notice that in order for the derivative to change sign, it must either pass through zero (a critical point) or have a discontinuity (which will show up as a singular point). Thus neighbouring regions of increase and decrease will be separated by critical and singular points.

Example 7.2.3

Consider the function

$$f(x) = x^4 - 6x^3$$

- Before we move on to derivatives, let us first examine the function itself as we did Section 7.1.
 - As $f(x)$ is a polynomial its domain is all real numbers.
 - Close to the origin, $f(x) \approx -6x^3$; far from the origin, $f(x) \approx x^4$.
 - Its y -intercept is at $(0,0)$. We find its x -intercepts by factoring

$$f(x) = x^4 - 6x^3 = x^3(x - 6)$$

So it crosses the x -axis at $x = 0, 6$.

- Again, since the function is a polynomial it does not have any vertical asymptotes. And since

$$\lim_{x \rightarrow \pm\infty} f(x) = \lim_{x \rightarrow \pm\infty} x^4(1 - 6/x) = +\infty$$

it does not have horizontal asymptotes — it blows up to $+\infty$ as x goes to $\pm\infty$.

- We can also determine where the function is positive or negative since we know it is continuous everywhere and zero at $x = 0, 6$. Thus we must examine the intervals

$$(-\infty, 0) \qquad (0, 6) \qquad (6, \infty)$$

When $x < 0$, $x^3 < 0$ and $x - 6 < 0$ so $f(x) = x^3(x - 6) = (\text{negative})(\text{negative}) > 0$. Similarly when $x > 6$, $x^3 > 0, x - 6 > 0$ we must have $f(x) > 0$. Finally when $0 < x < 6$, $x^3 > 0$ but $x - 6 < 0$ so $f(x) < 0$. Thus

interval	$(-\infty, 0)$	0	$(0, 6)$	6	$(6, \infty)$
$f(x)$	positive	0	negative	0	positive

2 No pun intended.

- Based on this information we can already construct a rough sketch.

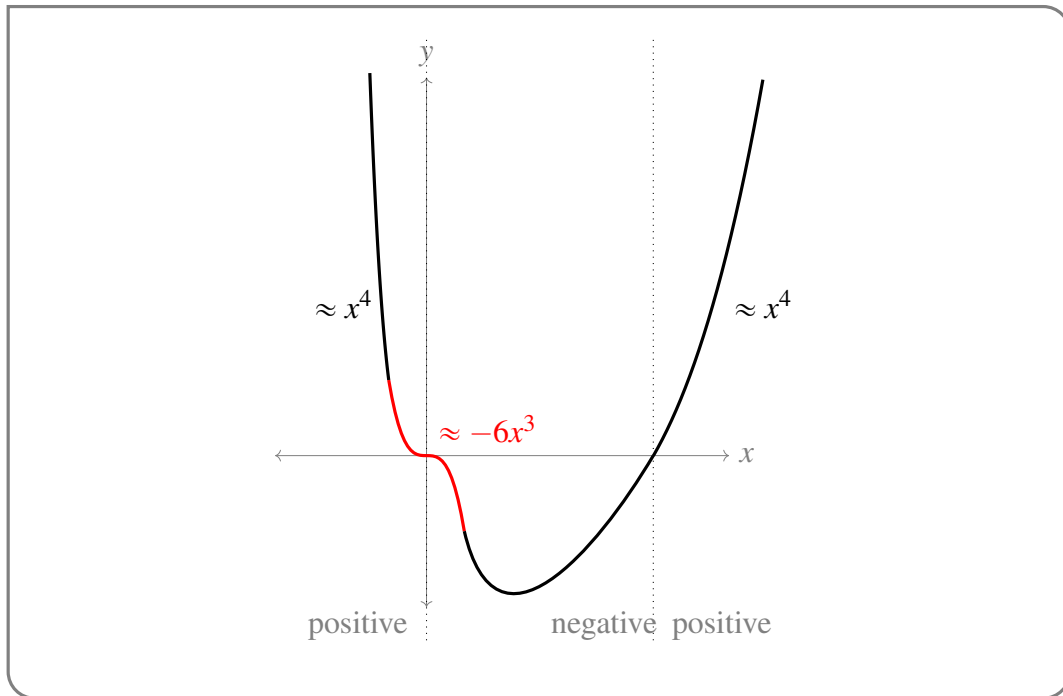

Note that there must be some point where the function changes from decreasing to increasing. That point will be a minimum (specifically a global minimum). We'll see details of the definition of minima and maxima in Definition 8.1.2, but for now, it's enough to see that there's a "low point" to call it a minimum.

- Now we compute its derivative

$$f'(x) = 4x^3 - 18x^2 = 2x^2(2x - 9)$$

- Since the function is a polynomial, it does not have any singular points, but it does have two critical points at $x = 0, 9/2$. These two critical points split the real line into 3 open intervals

$$(-\infty, 0) \qquad (0, 9/2) \qquad (9/2, \infty)$$

We need to determine the sign of the derivative in each intervals.

- When $x < 0$, $x^2 > 0$ but $(2x - 9) < 0$, so $f'(x) < 0$ and the function is decreasing.
- When $0 < x < 9/2$, $x^2 > 0$ but $(2x - 9) < 0$, so $f'(x) < 0$ and the function is still decreasing.
- When $x > 9/2$, $x^2 > 0$ and $(2x - 9) > 0$, so $f'(x) > 0$ and the function is increasing.

We can then summarise this in the following table

interval	$(-\infty, 0)$	0	$(0, 9/2)$	9/2	$(9/2, \infty)$
$f'(x)$	negative	0	negative	0	positive
	decreasing	horizontal tangent	decreasing	minimum	increasing

Since the derivative changes sign from negative to positive at the critical point $x = 9/2$, this point is a minimum. Its y-value is

$$\begin{aligned} y = f(9/2) &= \frac{9^3}{2^3} \left(\frac{9}{2} - 6 \right) \\ &= \frac{3^6}{2^3} \cdot \left(\frac{-3}{2} \right) = -\frac{3^7}{2^4} \end{aligned}$$

On the other hand, at $x = 0$ the derivative does not change sign; while this point has a horizontal tangent line it is not a minimum or maximum.

- Putting this information together we arrive at a quite reasonable sketch.

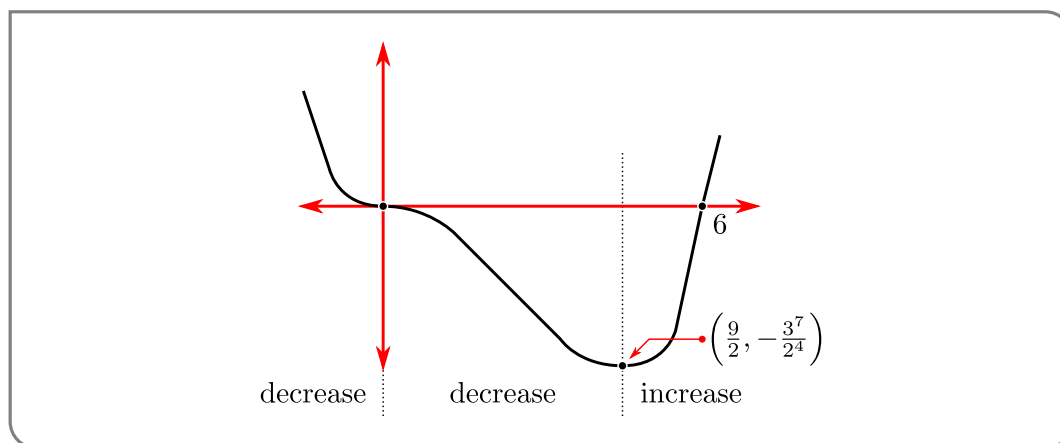

To improve upon this further we will examine the second derivative.

Example 7.2.3

7.3 ▲ Second derivative — concavity

Learning Objectives

- Explain what it means for a twice-differentiable function to be concave up or concave down on an interval.
- Determine whether a twice-differentiable function is concave up or concave down on an interval.
- Explain how information about the graph of a function may be extracted from the function, its derivative and its second derivative.
- Sketch the graph of a function $f(x)$ using the function, its derivative, and its second derivative.
- Sketch the graph of a function using characteristics determined from the function and

its derivatives, *without* scaffolding from an external source.

The second derivative $f''(x)$ tells us the rate at which the derivative changes. Perhaps the easiest way to understand how to interpret the sign of the second derivative is to think about what it implies about the slope of the tangent line to the graph of the function. Consider the following sketches of $y = 1 + x^2$ and $y = -1 - x^2$.

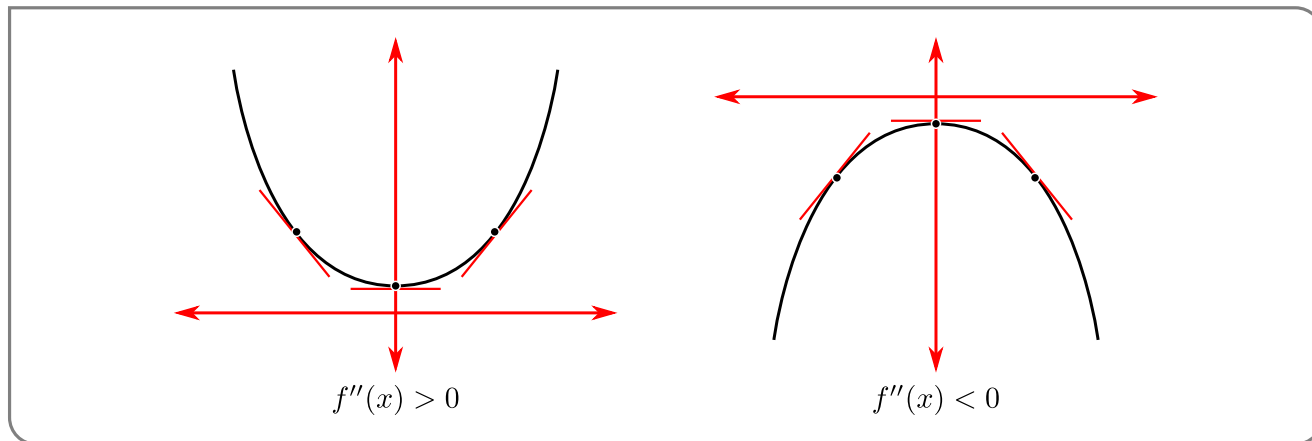

- In the case of $y = f(x) = 1 + x^2$, $f''(x) = 2 > 0$. Notice that this means the slope, $f'(x)$, of the line tangent to the graph at x increases as x increases. Looking at the figure on the left above, we see that the graph always lies above the tangent lines.
- For $y = f(x) = -1 - x^2$, $f''(x) = -2 < 0$. The slope, $f'(x)$, of the line tangent to the graph at x decreases as x increases. Looking at the figure on the right above, we see that the graph always lies below the tangent lines.

Similarly consider the following sketches of $y = x^{-1/2}$ and $y = \sqrt{4 - x}$:

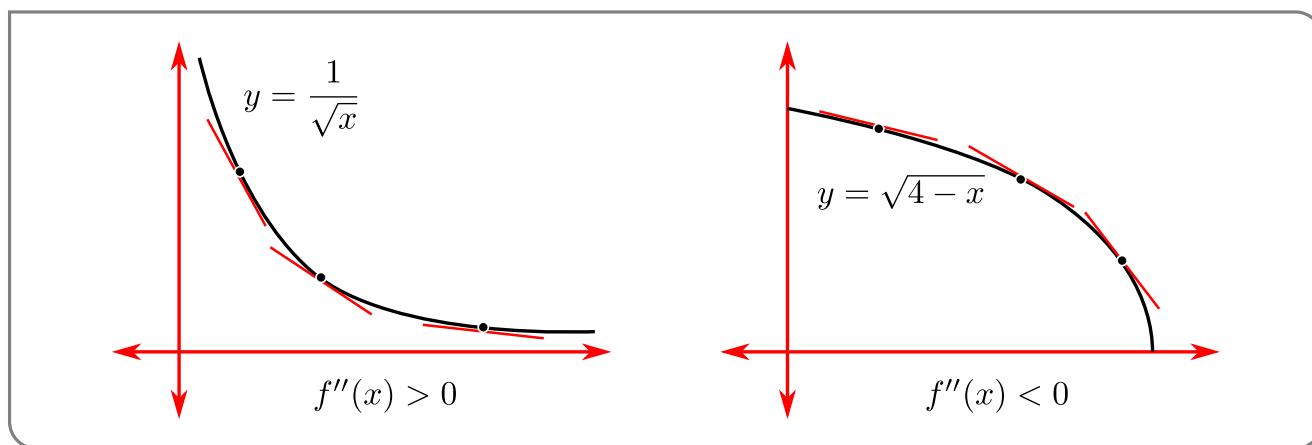

Both of their derivatives, $-\frac{1}{2}x^{-3/2}$ and $-\frac{1}{2}(4-x)^{-1/2}$, are negative, so they are decreasing functions. Examining second derivatives shows some differences.

- For the first function, $y''(x) = \frac{3}{4}x^{-5/2} > 0$, so the slopes of tangent lines are increasing with x and the graph lies above its tangent lines.

- However, the second function has $y''(x) = -\frac{1}{4}(4-x)^{-3/2} < 0$ so the slopes of the tangent lines are decreasing with x and the graph lies below its tangent lines.

More generally

Definition 7.3.1 (Concavity).

Let $f(x)$ be a continuous function on the interval $[a, b]$ and suppose its first and second derivatives exist on that interval.

- If $f''(x) > 0$ for all $a < x < b$, then the graph of f lies above its tangent lines for $a < x < b$ and it is said to be concave up on (a, b) .

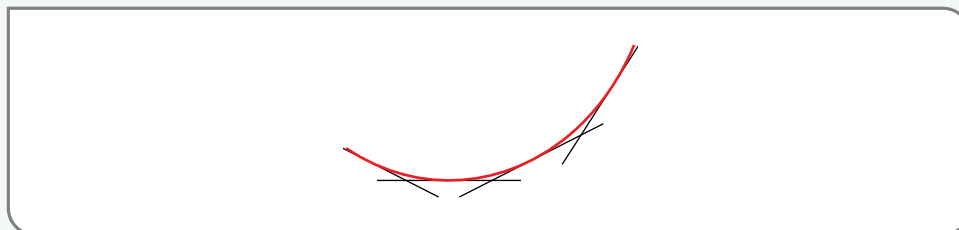

- If $f''(x) < 0$ for all $a < x < b$, then the graph of f lies below its tangent lines for $a < x < b$ and it is said to be concave down on (a, b) .

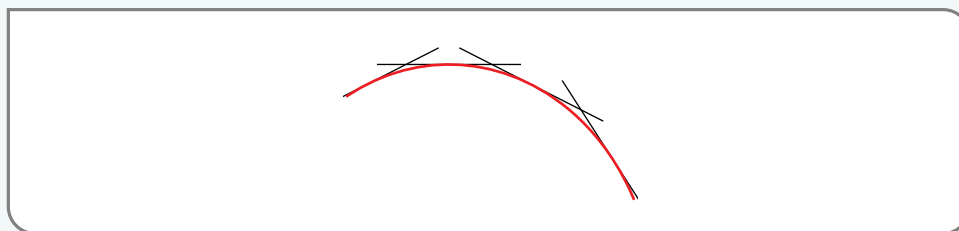

Note that one might also see the terms

- “convex” or “convex up” used in place of “concave up”, and
- “concave” or “convex down” used to mean “concave down”.

To avoid confusion we recommend the reader stick with the terms “concave up” and “concave down”.

The place where concavity of a function changes is itself worth knowing (and including on a sketch), which motivates the following definition.

Definition 7.3.2 (Inflection point).

Let c be a real number and let $f(x)$ be a function that is continuous on an open interval I containing c . If:

- the first and second derivatives $f'(x)$ and $f''(x)$ exist on I , except possibly at the single point c , and if
- f is concave up on one side of c and is concave down on the other side of c ,

then we say that $(c, f(c))$ is an inflection point of $y = f(x)$.

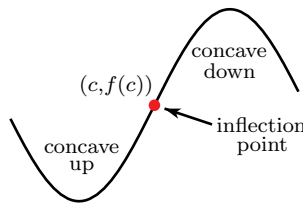

Informally, we can think of inflection points as points on a curve where its concavity changes.

Note the sign of $f''(x)$ can only change at values where $f''(x) = 0$ or where $f''(x)$ doesn't exist. So, if $f(x)$ has an inflection point at $x = a$, then $f''(a) = 0$ or $f''(a)$ does not exist.

Warning 7.3.3.

There is no universal agreement as to precisely when a singular point should also be called an inflection point. Much like the definitions of critical point and singular point, different people and different textbooks may use different conventions.

Let's now continue Example 7.2.3 by discussing the concavity of the curve.

Example 7.3.4 (Continuation of Example 7.2.3)

Consider again the function

$$f(x) = x^4 - 6x^3$$

- Its first derivative is $f'(x) = 4x^3 - 18x^2$, so

$$f''(x) = 12x^2 - 36x = 12x(x - 3)$$

- Thus the second derivative is zero (and potentially changes sign) at $x = 0, 3$. Thus we should consider the sign of the second derivative on the following intervals

$$(-\infty, 0)$$

$$(0, 3)$$

$$(3, \infty)$$

A little algebra gives us

interval	$(-\infty, 0)$	0	$(0, 3)$	3	$(3, \infty)$
$f''(x)$	positive	0	negative	0	positive
concavity	up	inflection	down	inflection	up

Since the concavity changes at both $x = 0$ and $x = 3$, the following are inflection points

$$(0, 0) \qquad (3, 3^4 - 6 \times 3^3) = (3, -3^4)$$

- Putting this together with the information we obtained earlier gives us the following sketch

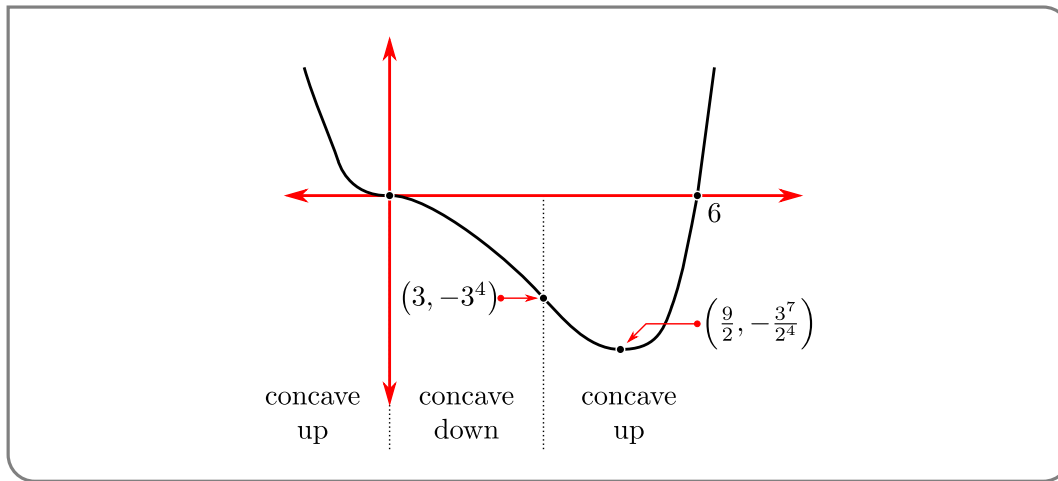

Example 7.3.4

Example 7.3.5 ($y = x^{1/3}$ and $y = x^{2/3}$)

Thus far, we have mostly considered functions having first and second derivatives on the entire interval of interest. In this example, we will consider the functions

$$f(x) = x^{1/3} \qquad g(x) = x^{2/3} .$$

(1) Features of $y = f(x)$ and $y = g(x)$ that are read off of $f(x)$ and $g(x)$:

- Since $f(0) = 0^{1/3} = 0$ and $g(0) = 0^{2/3} = 0$, the origin $(0, 0)$ lies on both $y = f(x)$ and $y = g(x)$.
- For example, $1^3 = 1$ and $(-1)^3 = -1$ so that the cube root of 1 is $1^{1/3} = 1$ and the cube root of -1 is $(-1)^{1/3} = -1$. In general,

$$x^{1/3} \begin{cases} < 0 & \text{if } x < 0 \\ = 0 & \text{if } x = 0 \\ > 0 & \text{if } x > 0 \end{cases}$$

Consequently the graph $y = f(x) = x^{1/3}$ lies below the x -axis when $x < 0$ and lies above the x -axis when $x > 0$. On the other hand, the graph $y = g(x) = x^{2/3} = [x^{1/3}]^2$ lies on or above the x -axis for all x .

- As $x \rightarrow +\infty$, both $y = f(x) = x^{1/3}$ and $y = g(x) = x^{2/3}$ tend to $+\infty$.
- As $x \rightarrow -\infty$, $y = f(x) = x^{1/3}$ tends to $-\infty$ and $y = g(x) = x^{2/3}$ tends to $+\infty$.

(2) Features of $y = f(x)$ and $y = g(x)$ that are read off of $f'(x)$ and $g'(x)$:

$$f'(x) = \begin{cases} \frac{1}{3}x^{-2/3} & \text{if } x \neq 0 \\ \text{undefined} & \text{if } x = 0 \end{cases} \implies f'(x) > 0 \text{ for all } x \neq 0$$

$$g'(x) = \begin{cases} \frac{2}{3}x^{-1/3} & \text{if } x \neq 0 \\ \text{undefined} & \text{if } x = 0 \end{cases} \implies g'(x) \begin{cases} < 0 & \text{if } x < 0 \\ > 0 & \text{if } x > 0 \end{cases}$$

So the graph $y = f(x)$ is increasing on both sides of the singular point $x = 0$, while the graph $y = g(x)$ is decreasing to the left of $x = 0$ and is increasing to the right of $x = 0$. As $x \rightarrow 0$, $f'(x)$ and $g'(x)$ become infinite. That is, the slopes of the tangent lines at $(x, f(x))$ and $(x, g(x))$ become infinite and the tangent lines become vertical.

(3) Features of $y = f(x)$ and $y = g(x)$ that are read off of $f''(x)$ and $g''(x)$:

$$f''(x) = \begin{cases} -\frac{2}{9}x^{-5/3} = -\frac{2}{9}[x^{-1/3}]^5 & \text{if } x \neq 0 \\ \text{undefined} & \text{if } x = 0 \end{cases} \implies f''(x) \begin{cases} > 0 & \text{if } x < 0 \\ < 0 & \text{if } x > 0 \end{cases}$$

$$g''(x) = \begin{cases} -\frac{2}{9}x^{-4/3} = -\frac{2}{9}[x^{-1/3}]^4 & \text{if } x \neq 0 \\ \text{undefined} & \text{if } x = 0 \end{cases} \implies g''(x) < 0 \text{ for all } x \neq 0$$

So the graph $y = g(x)$ is concave down on both sides of the singular point $x = 0$, while the graph $y = f(x)$ is concave up to the left of $x = 0$ and is concave down to the right of $x = 0$.

By way of summary, we have, for $f(x)$,

interval	$(-\infty, 0)$	0	$(0, \infty)$
$f(x)$	negative	0	positive
$f'(x)$	positive	undefined	positive
	increasing		increasing
$f''(x)$	positive	undefined	negative
	concave up	inflection	concave down

and for $g(x)$,

interval	$(-\infty, 0)$	0	$(0, \infty)$
$g(x)$	positive	0	positive
$g'(x)$	negative	undefined	positive
	decreasing		increasing
$g''(x)$	negative	undefined	negative
	concave down		concave down

Since the concavity changes at $x = 0$ for $y = f(x)$, but not for $y = g(x)$, $(0, 0)$ is an inflection point for $y = f(x)$, but not for $y = g(x)$. We have the following sketch for $y = f(x) = x^{1/3}$,

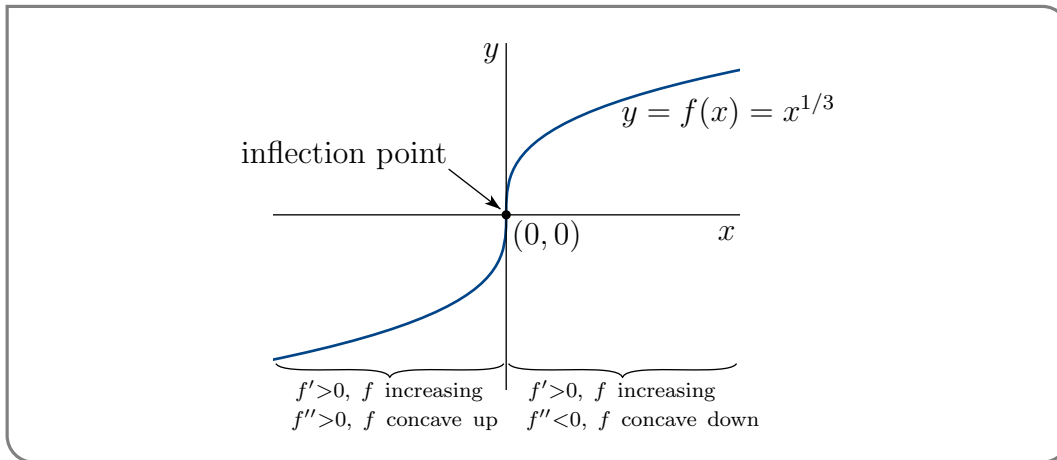

and the following sketch for $y = g(x) = x^{2/3}$.

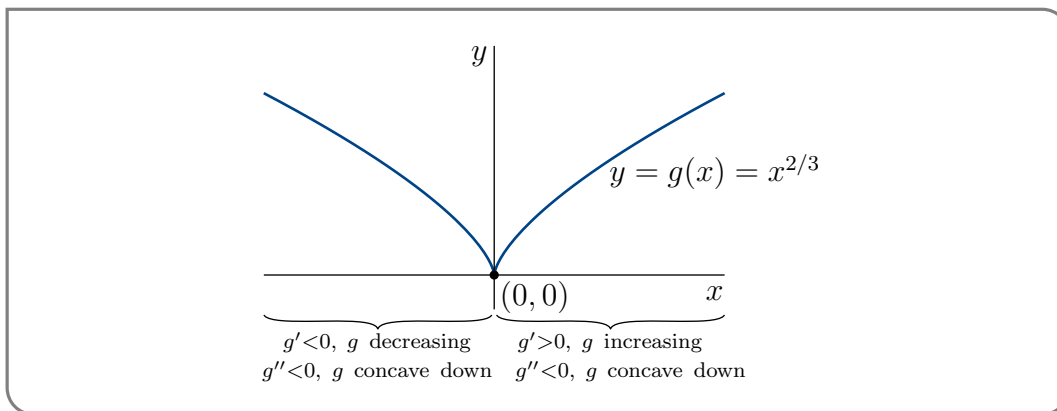

Note that the curve $y = f(x) = x^{1/3}$ looks perfectly smooth, even though $f'(x) \rightarrow \infty$ as $x \rightarrow 0$. There is no kink or discontinuity at $(0, 0)$. The singularity at $x = 0$ has caused the y -axis to be a vertical tangent to the curve, but has not prevented the curve from looking smooth.

Example 7.3.5

7.4 ▲ Symmetries

Learning Objectives

- Recognize when functions are even, odd, or periodic, and understand how these properties influence the graph of a function.

Before we proceed to more examples, we should examine some simple symmetries possessed by some functions. We'll look at three symmetries — evenness, oddness and periodicity. If a function possesses one of these symmetries then it can be exploited to reduce the amount of work required to sketch the graph of the function. (You can, however, still sketch even and odd graphs without taking advantage of evenness and oddness.)

►► **Even and odd functions**

Let us start with even and odd functions.

Definition 7.4.1.

A function $f(x)$ is said to be even if $f(-x) = f(x)$ for all x .

Definition 7.4.2.

A function $f(x)$ is said to be odd if $f(-x) = -f(x)$ for all x .

Example 7.4.3

Let $f(x) = x^2$ and $g(x) = x^3$. Then

$$f(-x) = (-x)^2 = x^2 = f(x)$$

$$g(-x) = (-x)^3 = -x^3 = -g(x)$$

Hence $f(x)$ is even and $g(x)$ is odd.

Notice any polynomial involving only even powers of x will be even

$$f(x) = 7x^6 + 2x^4 - 3x^2 + 5 \qquad \text{remember that } 5 = 5x^0$$

$$f(-x) = 7(-x)^6 + 2(-x)^4 - 3(-x)^2 + 5$$

$$= 7x^6 + 2x^4 - 3x^2 + 5 = f(x)$$

Similarly any polynomial involving only odd powers of x will be odd

$$g(x) = 2x^5 - 8x^3 - 3x$$

$$g(-x) = 2(-x)^5 - 8(-x)^3 - 3(-x)$$

$$= -2x^5 + 8x^3 + 3x = -g(x)$$

Example 7.4.3

Not all even and odd functions are polynomials. For example

$$|x| \qquad \cos x \qquad \text{and } (e^x + e^{-x})$$

are all even, while

$$\sin x \qquad \tan x \qquad \text{and } (e^x - e^{-x})$$

are all odd. Indeed, given any function $f(x)$, the function

$$g(x) = f(x) + f(-x) \qquad \text{will be even, and}$$

$$h(x) = f(x) - f(-x) \qquad \text{will be odd.}$$

Now let us see how we can make use of these symmetries to make graph sketching easier. Let $f(x)$ be an even function. Then

the point (x_0, y_0) lies on the graph of $y = f(x)$

if and only if $y_0 = f(x_0) = f(-x_0)$ which is the case if and only if

the point $(-x_0, y_0)$ lies on the graph of $y = f(x)$.

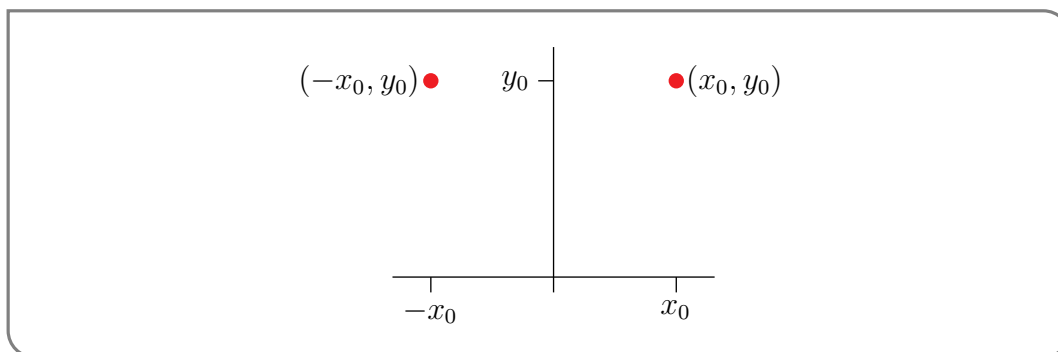

Notice that the points (x_0, y_0) and $(-x_0, y_0)$ are just reflections of each other across the y -axis. Consequently, to draw the graph $y = f(x)$, it suffices to draw the part of the graph with $x \geq 0$ and then reflect it in the y -axis. Here is an example. The part with $x \geq 0$ is on the left and the full graph is on the right.

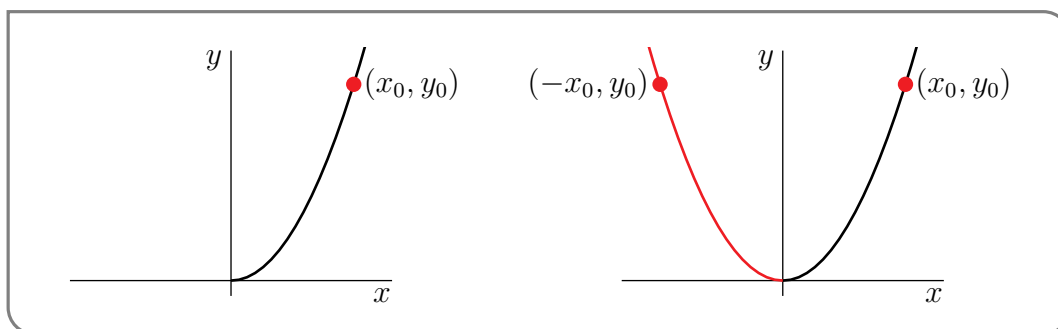

Very similarly, when $f(x)$ is an odd function then

(x_0, y_0) lies on the graph of $y = f(x)$

if and only if

$(-x_0, -y_0)$ lies on the graph of $y = f(x)$

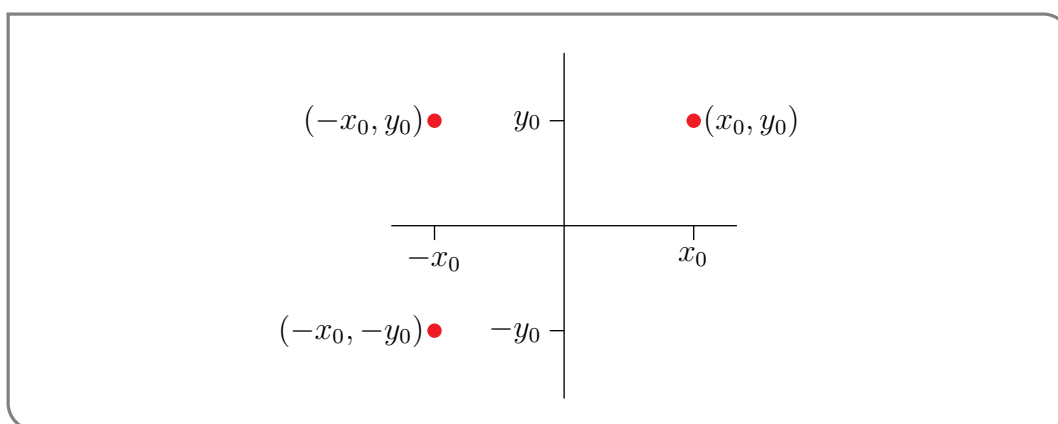

Now the symmetry is a little harder to interpret pictorially. To get from (x_0, y_0) to $(-x_0, -y_0)$ one can first reflect (x_0, y_0) in the y -axis to get to $(-x_0, y_0)$ and then reflect the result in the x -axis to get to $(-x_0, -y_0)$. Consequently, to draw the graph $y = f(x)$, it suffices to draw the part of the graph with $x \geq 0$ and then reflect it first in the y -axis and then in the x -axis. Here is an example. First, here is the part of the graph with $x \geq 0$.

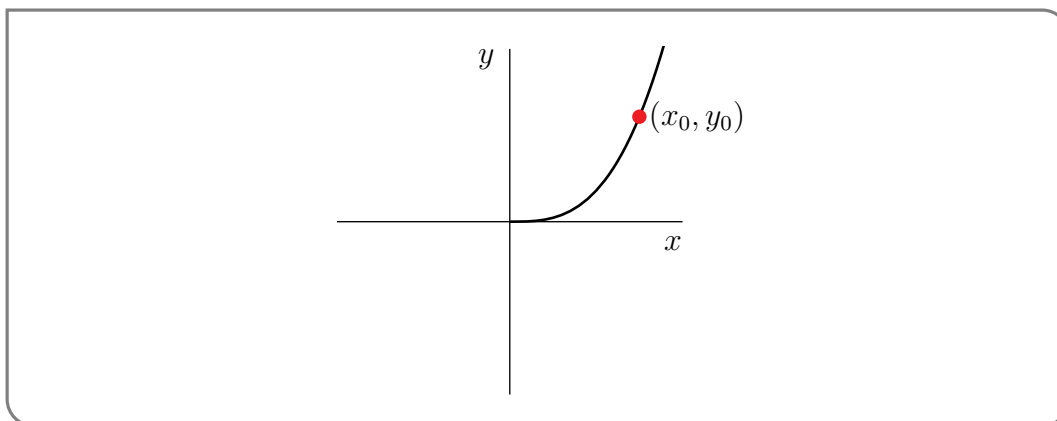

Next, as an intermediate step (usually done in our heads rather than on paper), we add in the reflection in the y -axis.

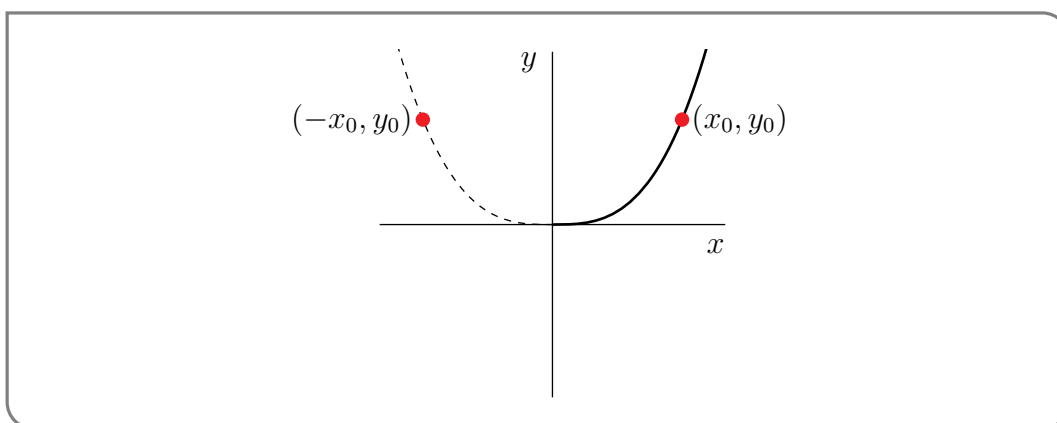

Finally to get the full graph, we reflect the dashed line in the x -axis

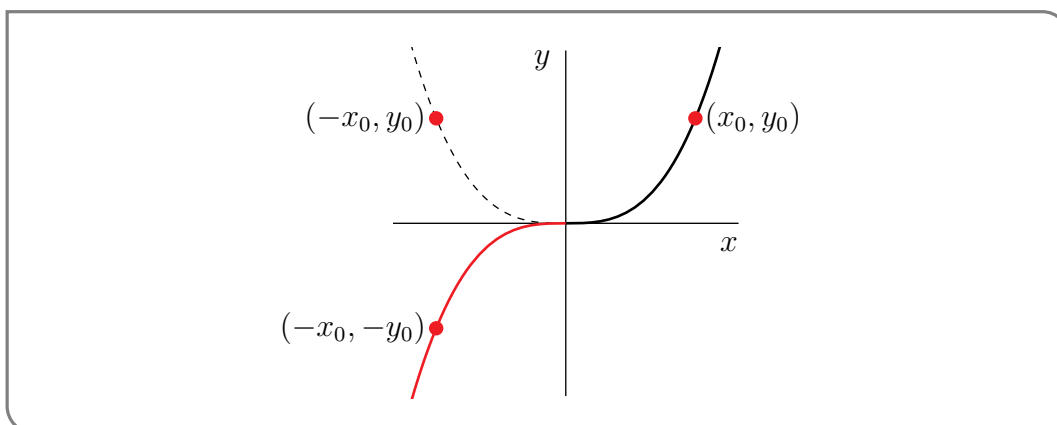

and then remove the dashed line.

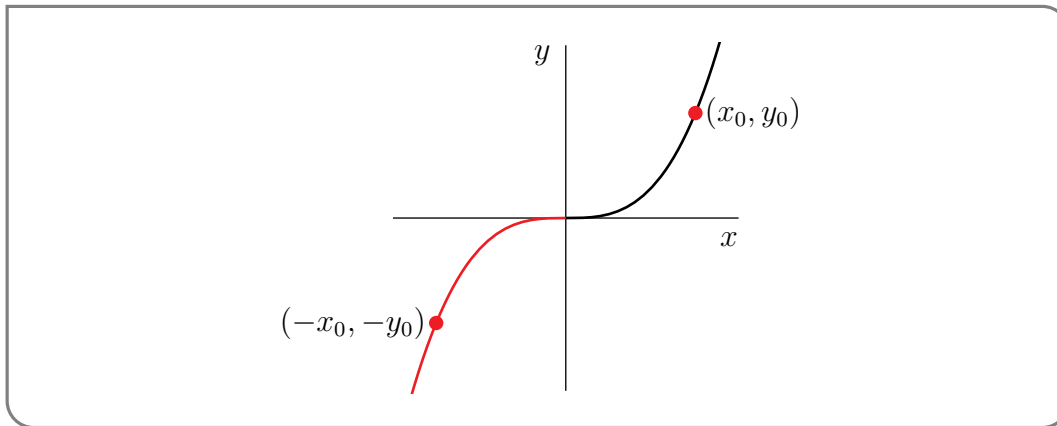

Let's do a more substantial example of an even function

Example 7.4.4

Consider the function

$$g(x) = \frac{x^2 - 9}{x^2 + 3}$$

- The function is even since

$$g(-x) = \frac{(-x)^2 - 9}{(-x)^2 + 3} = \frac{x^2 - 9}{x^2 + 3} = g(x)$$

Thus it suffices to study the function for $x \geq 0$ because we can then use the even symmetry to understand what happens for $x < 0$.

- The function is defined on all real numbers since its denominator $x^2 + 3$ is never zero. Hence it has no vertical asymptotes.
- The y-intercept is $g(0) = \frac{-9}{3} = -3$. And x-intercepts are given by the solution of $x^2 - 9 = 0$, namely $x = \pm 3$. Note that we only need to establish $x = 3$ as an intercept. Then since g is even, we know that $x = -3$ is also an intercept.
- To find the horizontal asymptotes we compute the limit as $x \rightarrow +\infty$

$$\begin{aligned} \lim_{x \rightarrow \infty} g(x) &= \lim_{x \rightarrow \infty} \frac{x^2 - 9}{x^2 + 3} \\ &= \lim_{x \rightarrow \infty} \frac{x^2(1 - 9/x^2)}{x^2(1 + 3/x^2)} \\ &= \lim_{x \rightarrow \infty} \frac{1 - 9/x^2}{1 + 3/x^2} = 1 \end{aligned}$$

Thus $y = 1$ is a horizontal asymptote. Indeed, this is also the asymptote as $x \rightarrow -\infty$ since by the even symmetry

$$\lim_{x \rightarrow -\infty} g(x) = \lim_{x \rightarrow \infty} g(-x) = \lim_{x \rightarrow \infty} g(x).$$

- We can already produce a quite reasonable sketch just by putting in the horizontal asymptote and the intercepts and drawing a smooth curve between them.

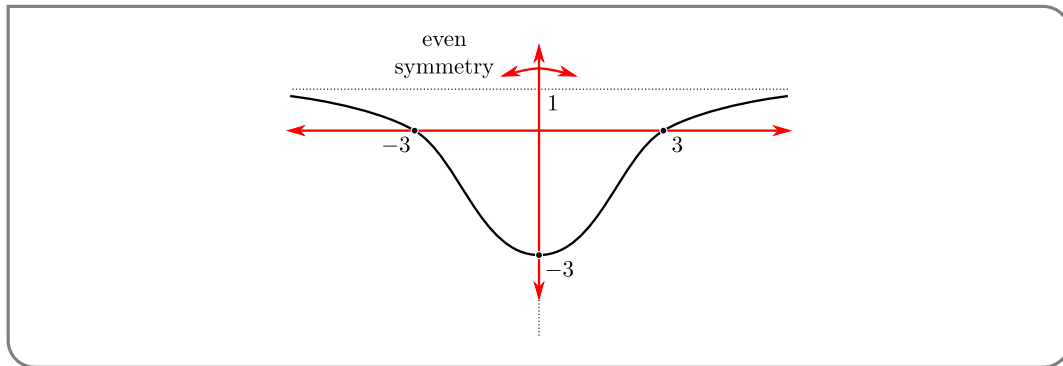

Note that we have drawn the function as never crossing the asymptote $y = 1$, however we have not yet proved that. We could by trying to solve $g(x) = 1$.

$$\begin{aligned}\frac{x^2 - 9}{x^2 + 3} &= 1 \\ x^2 - 9 &= x^2 + 3 \\ -9 &= 3 \text{ so no solutions.}\end{aligned}$$

Alternatively we could analyse the first derivative to see how the function approaches the asymptote.

- Now we turn to the first derivative:

$$\begin{aligned}g'(x) &= \frac{(x^2 + 3)(2x) - (x^2 - 9)(2x)}{(x^2 + 3)^2} \\ &= \frac{24x}{(x^2 + 3)^2}\end{aligned}$$

There are no singular points since the denominator is nowhere zero. The only critical point is at $x = 0$. Thus we must find the sign of $g'(x)$ on the intervals

$$(-\infty, 0) \qquad (0, \infty)$$

- When $x > 0$, $24x > 0$ and $(x^2 + 3) > 0$, so $g'(x) > 0$ and the function is increasing. By even symmetry we know that when $x < 0$ the function must be decreasing. Hence the critical point $x = 0$ is a local minimum of the function.
- Notice that since the function is increasing for $x > 0$ and the function must approach the horizontal asymptote $y = 1$ from below. Thus the sketch above is quite accurate.
- Now consider the second derivative:

$$\begin{aligned}g''(x) &= \frac{d}{dx} \frac{24x}{(x^2 + 3)^2} \\ &= \frac{(x^2 + 3)^2 \cdot 24 - 24x \cdot 2(x^2 + 3) \cdot 2x}{(x^2 + 3)^4} && \text{cancel a factor of } (x^2 + 3) \\ &= \frac{(x^2 + 3) \cdot 24 - 96x^2}{(x^2 + 3)^3} \\ &= \frac{72(1 - x^2)}{(x^2 + 3)^3}\end{aligned}$$

- It is clear that $g''(x) = 0$ when $x = \pm 1$. Note that, again, we can infer the zero at $x = -1$ from the zero at $x = 1$ by the even symmetry. Thus we need to examine the sign of $g''(x)$ the intervals

$$(-\infty, -1) \qquad (-1, 1) \qquad (1, \infty)$$

- When $|x| < 1$ we have $(1 - x^2) > 0$ so that $g''(x) > 0$ and the function is concave up. When $|x| > 1$ we have $(1 - x^2) < 0$ so that $g''(x) < 0$ and the function is concave down. Thus the points $x = \pm 1$ are inflection points. Their coordinates are $(\pm 1, g(\pm 1)) = (\pm 1, -2)$.
- Putting this together gives the following sketch:

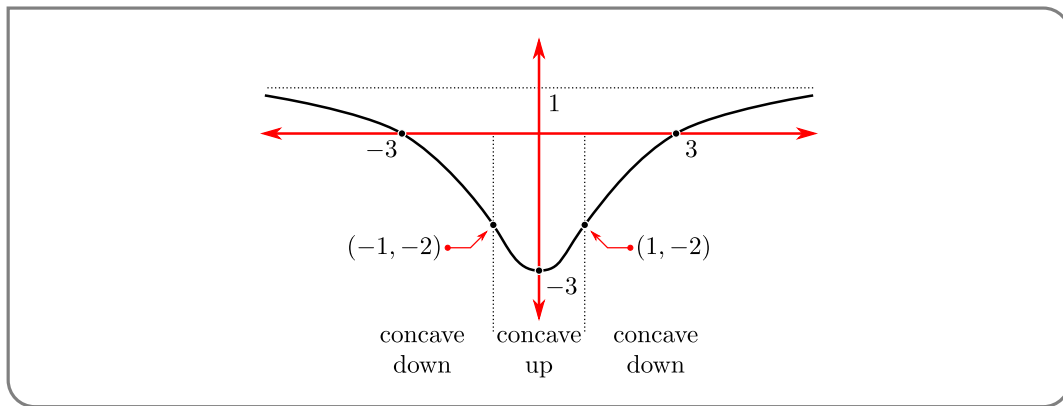

Example 7.4.4

►► **Periodicity**

Another symmetry we should consider is periodicity.

Definition 7.4.5.

A function $f(x)$ is said to be periodic, with period $P > 0$, if $f(x + P) = f(x)$ for all x .

Note that if $f(x + P) = f(x)$ for all x , then replacing x by $x + P$, we have

$$f(x + 2P) = f(x + P + P) = f(x + P) = f(x).$$

More generally $f(x + kP) = f(x)$ for all integers k . Thus if f has period P , then it also has period nP for all natural numbers n . The smallest period is called the fundamental period.

Example 7.4.6

The classic example of a periodic function is $f(x) = \sin x$, which has period 2π since $f(x + 2\pi) = \sin(x + 2\pi) = \sin x = f(x)$.

Example 7.4.6

If $f(x)$ has period P then

(x_0, y_0) lies on the graph of $y = f(x)$

if and only if $y_0 = f(x_0) = f(x_0 + P)$ which is the case if and only if

$(x_0 + P, y_0)$ lies on the graph of $y = f(x)$

and, more generally,

(x_0, y_0) lies on the graph of $y = f(x)$

if and only if

$(x_0 + nP, y_0)$ lies on the graph of $y = f(x)$

for all integers n .

Note that the point $(x_0 + P, y_0)$ can be obtained by translating (x_0, y_0) horizontally by P . Similarly the point $(x_0 + nP, y_0)$ can be found by repeatedly translating (x_0, y_0) horizontally by P .

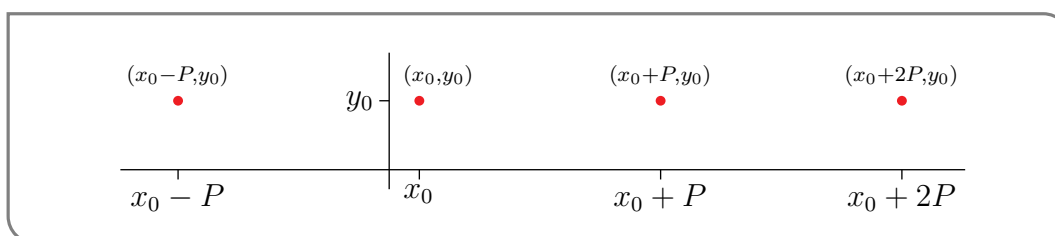

Consequently, to draw the graph $y = f(x)$, it suffices to draw one period of the graph, say the part with $0 \leq x \leq P$, and then translate it repeatedly. Here is an example. Here is a sketch of one period

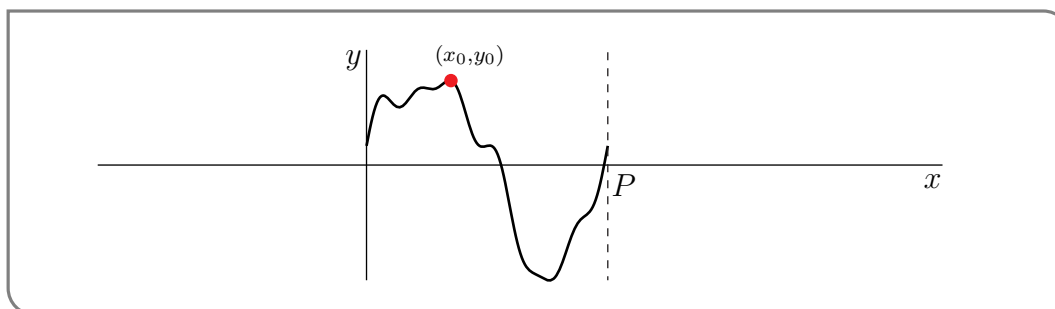

and here is the full sketch.

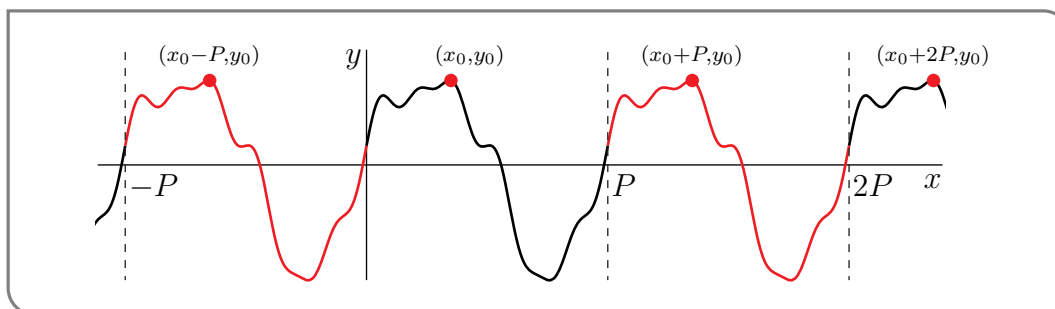

7.5 ▲ A checklist for sketching

Above we have described how we can use our accumulated knowledge of derivatives to quickly identify the most important qualitative features of graphs $y = f(x)$. Here we give the reader a quick checklist of things to consider in order to produce an accurate sketch based on properties that are easily read off from $f(x)$, $f'(x)$ and $f''(x)$.

Note that the list below tells you pieces of information that can be helpful for sketching in general, but which may or may not be helpful for a particular function. When you're just beginning, it can be good to go down the checklist to make sure you haven't missed anything important. But, as your graphing skills improve, you'll start noticing important features of a graph without needing this level of scaffolding.

►► A Sketching Checklist.

(1) Features of $y = f(x)$ that are read off of $f(x)$:

- First check where $f(x)$ is defined. Then
- $y = f(x)$ is plotted only for x 's in the domain of $f(x)$, i.e. where $f(x)$ is defined.
- $y = f(x)$ has vertical asymptotes at the points where $f(x)$ blows up to $\pm\infty$.
- Determine whether the function is even, odd, periodic, or none of these.
- $y = f(x)$ is first plotted for $x \geq 0$ if the function is even or odd. The rest of the sketch is then created by reflections.
- $y = f(x)$ is first plotted for a single period if the function is periodic. The rest of the sketch is then created by translations.
- Next compute $f(0)$, $\lim_{x \rightarrow \infty} f(x)$ and $\lim_{x \rightarrow -\infty} f(x)$ and look for solutions to $f(x) = 0$ that you can easily find. Then
- $y = f(x)$ has y -intercept $(0, f(0))$.
- $y = f(x)$ has x -intercept $(a, 0)$ whenever $f(a) = 0$
- $y = f(x)$ has horizontal asymptote $y = Y$ if $\lim_{x \rightarrow \infty} f(x) = L$ or $\lim_{x \rightarrow -\infty} f(x) = L$.
- Think about asymptotic behaviour more generally – is there a simpler function $f(x)$ resembles when x is large and negative, large and positive, or close to the origin?

(2) Features of $y = f(x)$ that are read off of $f'(x)$:

- Compute $f'(x)$ and determine its critical points and singular points, then
- $y = f(x)$ has a horizontal tangent at the points where $f'(x) = 0$.
- $y = f(x)$ is increasing at points where $f'(x) > 0$.
- $y = f(x)$ is decreasing at points where $f'(x) < 0$.
- $y = f(x)$ has vertical tangents or vertical asymptotes at the points where $f'(x) = \pm\infty$.

(3) Features of $y = f(x)$ that are read off of $f''(x)$:

- Compute $f''(x)$ and determine where $f''(x) = 0$ or does not exist, then

- $y = f(x)$ is concave up at points where $f''(x) > 0$.
- $y = f(x)$ is concave down at points where $f''(x) < 0$.
- $y = f(x)$ may or may not have inflection points where $f''(x) = 0$.

7.6 ▲ Sketching examples

Example 7.6.1 (Sketch $f(x) = x^3 - 3x + 1$)

(1) Reading from $f(x)$:

- The function is a polynomial so it is defined everywhere.
- Since $f(-x) = -x^3 + 3x + 1 \neq \pm f(x)$, it is not even or odd. Nor is it periodic.
- The y -intercept is $y = 1$. The x -intercepts are not easily computed since it is a cubic polynomial that does not factor nicely³. So for this example we don't worry about finding them.
- Since it is a polynomial it has no vertical asymptotes.
- For very large x , both positive and negative, the x^3 term in $f(x)$ dominates the other two terms so that

$$f(x) \rightarrow \begin{cases} +\infty & \text{as } x \rightarrow +\infty \\ -\infty & \text{as } x \rightarrow -\infty \end{cases}$$

and there are no horizontal asymptotes.

(2) We now compute the derivative:

$$f'(x) = 3x^2 - 3 = 3(x^2 - 1) = 3(x + 1)(x - 1)$$

- The critical points (where $f'(x) = 0$) are at $x = \pm 1$. Further since the derivative is a polynomial it is defined everywhere and there are no singular points. The critical points split the real line into the intervals $(-\infty, -1)$, $(-1, 1)$ and $(1, \infty)$.
- When $x < -1$, both factors $(x + 1), (x - 1) < 0$ so $f'(x) > 0$.
- Similarly when $x > 1$, both factors $(x + 1), (x - 1) > 0$ so $f'(x) > 0$.
- When $-1 < x < 1$, $(x - 1) < 0$ but $(x + 1) > 0$ so $f'(x) < 0$.
- Summarising all this

	$(-\infty, -1)$	-1	$(-1, 1)$	1	$(1, \infty)$
$f'(x)$	positive	0	negative	0	positive
	increasing	maximum	decreasing	minimum	increasing

³ With the aid of a computer we can find the x -intercepts numerically: $x \approx -1.879385242, 0.3472963553$, and 1.532088886 .

So $(-1, f(-1)) = (-1, 3)$ is a local maximum and $(1, f(1)) = (1, -1)$ is a local minimum.

(3) Compute the second derivative:

$$f''(x) = 6x$$

- The second derivative is zero when $x = 0$, and the problem is quite easy to analyse. Clearly, $f''(x) < 0$ when $x < 0$ and $f''(x) > 0$ when $x > 0$.
- Thus f is concave down for $x < 0$, concave up for $x > 0$ and has an inflection point at $x = 0$.

Putting this all together gives:

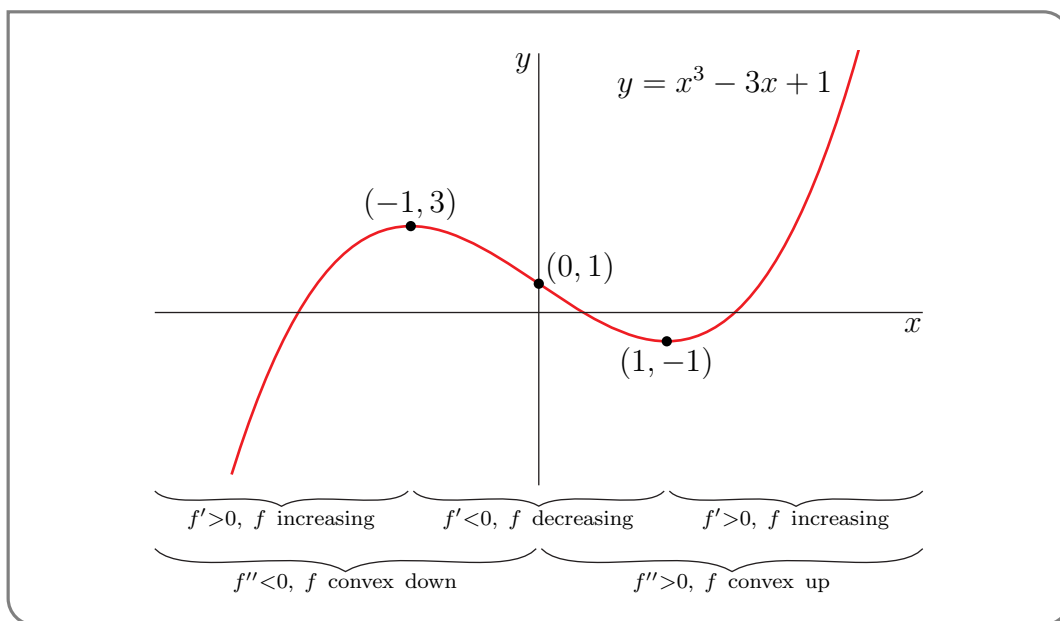

Example 7.6.1

Example 7.6.2 (Sketch $f(x) = x^4 - 4x^3$)

(1) Reading from $f(x)$:

- The function is a polynomial so it is defined everywhere.
- Since $f(-x) = x^4 + 4x^3 \neq \pm f(x)$, it is not even or odd. Nor is it periodic.
- The y -intercept is $y = f(0) = 0$, while the x -intercepts are given by the solution of

$$\begin{aligned} f(x) = x^4 - 4x^3 &= 0 \\ x^3(x - 4) &= 0 \end{aligned}$$

Hence the x -intercepts are 0, 4.

- Since f is a polynomial it does not have any vertical asymptotes.
- For very large x , both positive and negative, the x^4 term in $f(x)$ dominates the other term so that

$$f(x) \rightarrow \begin{cases} +\infty & \text{as } x \rightarrow +\infty \\ +\infty & \text{as } x \rightarrow -\infty \end{cases}$$

and the function has no horizontal asymptotes.

(2) Now compute the derivative $f'(x)$:

$$f'(x) = 4x^3 - 12x^2 = 4(x-3)x^2$$

- The critical points are at $x = 0, 3$. Since the function is a polynomial there are no singular points. The critical points split the real line into the intervals $(-\infty, 0)$, $(0, 3)$ and $(3, \infty)$.
- When $x < 0$, $x^2 > 0$ and $x - 3 < 0$, so $f'(x) < 0$.
- When $0 < x < 3$, $x^2 > 0$ and $x - 3 < 0$, so $f'(x) < 0$.
- When $3 < x$, $x^2 > 0$ and $x - 3 > 0$, so $f'(x) > 0$.
- Summarising all this

	$(-\infty, 0)$	0	$(0, 3)$	3	$(3, \infty)$
$f'(x)$	negative	0	negative	0	positive
	decreasing	horizontal tangent	decreasing	minimum	increasing

So the point $(3, f(3)) = (3, -27)$ is a local minimum. The point $(0, f(0)) = (0, 0)$ is neither a minimum nor a maximum, even though $f'(0) = 0$.

(3) Now examine $f''(x)$:

$$f''(x) = 12x^2 - 24x = 12x(x-2)$$

- So $f''(x) = 0$ when $x = 0, 2$. This splits the real line into the intervals $(-\infty, 0)$, $(0, 2)$ and $(2, \infty)$.
- When $x < 0$, $x - 2 < 0$ and so $f''(x) > 0$.
- When $0 < x < 2$, $x > 0$ and $x - 2 < 0$ and so $f''(x) < 0$.
- When $2 < x$, $x > 0$ and $x - 2 > 0$ and so $f''(x) > 0$.
- Thus the function is convex up for $x < 0$, then convex down for $0 < x < 2$, and finally convex up again for $x > 2$. Hence $(0, f(0)) = (0, 0)$ and $(2, f(2)) = (2, -16)$ are inflection points.

Putting all this information together gives us the following sketch.

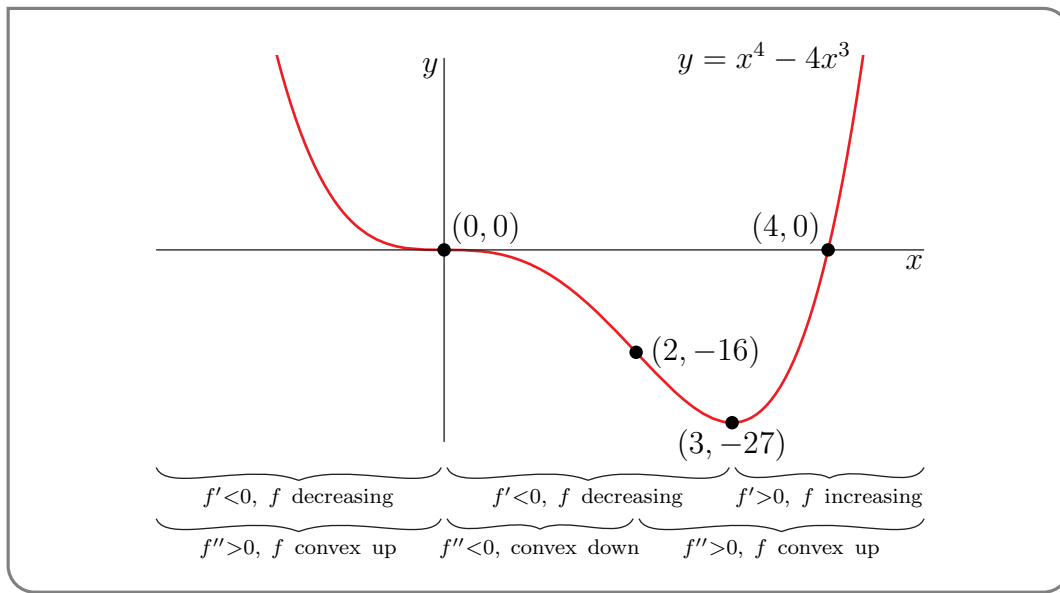

Example 7.6.2

Example 7.6.3 ($f(x) = x^3 - 6x^2 + 9x - 54$)

(1) Reading from $f(x)$:

- The function is a polynomial so it is defined everywhere.
- Since $f(-x) = -x^3 - 6x^2 - 9x - 54 \neq \pm f(x)$, it is not even or odd. Nor is it periodic.
- The y -intercept is $y = f(0) = -54$, while the x -intercepts are given by the solution of

$$\begin{aligned}
 f(x) &= x^3 - 6x^2 + 9x - 54 = 0 \\
 x^2(x - 6) + 9(x - 6) &= 0 \\
 (x^2 + 9)(x - 6) &= 0
 \end{aligned}$$

Hence the only x -intercept is 6.

- Since f is a polynomial it does not have any vertical asymptotes.
- For very large x , both positive and negative, the x^3 term in $f(x)$ dominates the other term so that

$$f(x) \rightarrow \begin{cases} +\infty & \text{as } x \rightarrow +\infty \\ -\infty & \text{as } x \rightarrow -\infty \end{cases}$$

and the function has no horizontal asymptotes.

(2) Now compute the derivative $f'(x)$:

$$\begin{aligned}
 f'(x) &= 3x^2 - 12x + 9 \\
 &= 3(x^2 - 4x + 3) = 3(x - 3)(x - 1)
 \end{aligned}$$

- The critical points are at $x = 1, 3$. Since the function is a polynomial there are no singular points. The critical points split the real line into the intervals $(-\infty, 1)$, $(1, 3)$ and $(3, \infty)$.
- When $x < 1$, $(x - 1) < 0$ and $(x - 3) < 0$, so $f'(x) > 0$.
- When $1 < x < 3$, $(x - 1) > 0$ and $(x - 3) < 0$, so $f'(x) < 0$.
- When $3 < x$, $(x - 1) > 0$ and $(x - 3) > 0$, so $f'(x) > 0$.
- Summarising all this

	$(-\infty, 1)$	1	$(1, 3)$	3	$(3, \infty)$
$f'(x)$	positive	0	negative	0	positive
	increasing	maximum	decreasing	minimum	increasing

So the point $(1, f(1)) = (1, -50)$ is a local maximum. The point $(3, f(3)) = (3, -54)$ is a local minimum.

(3) Now examine $f''(x)$:

$$f''(x) = 6x - 12$$

- So $f''(x) = 0$ when $x = 2$. This splits the real line into the intervals $(-\infty, 2)$ and $(2, \infty)$.
- When $x < 2$, $f''(x) < 0$.
- When $x > 2$, $f''(x) > 0$.
- Thus the function is convex down for $x < 2$, then convex up for $x > 2$. Hence $(2, f(2)) = (2, -52)$ is an inflection point.

Putting all this information together gives us the following sketch.

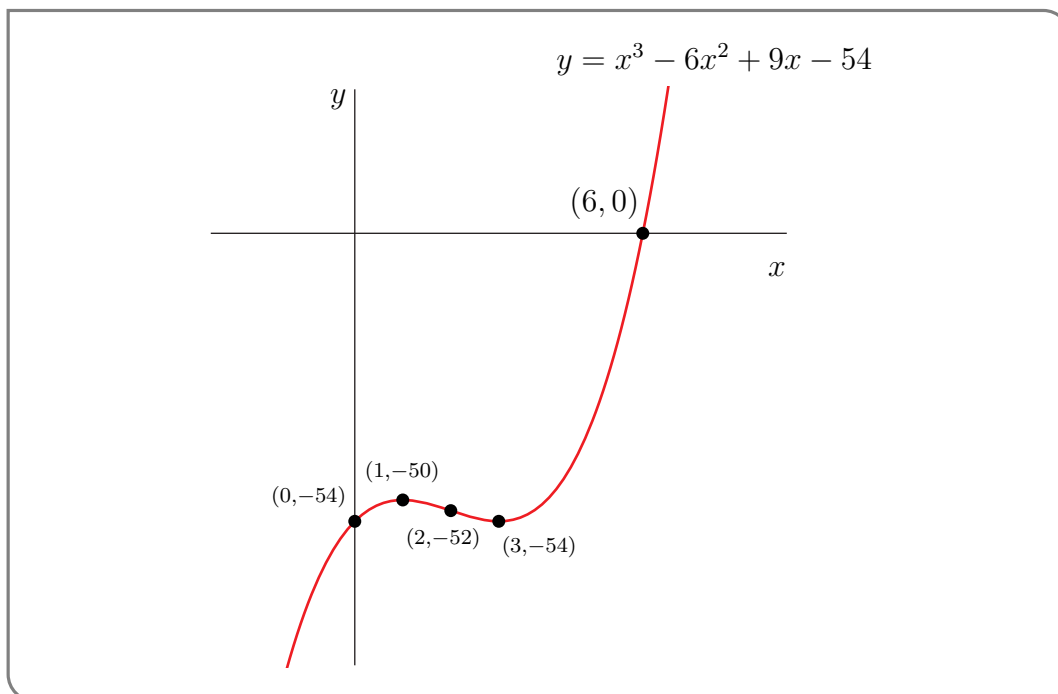

and if we zoom in around the interesting points (minimum, maximum and inflection point), we have

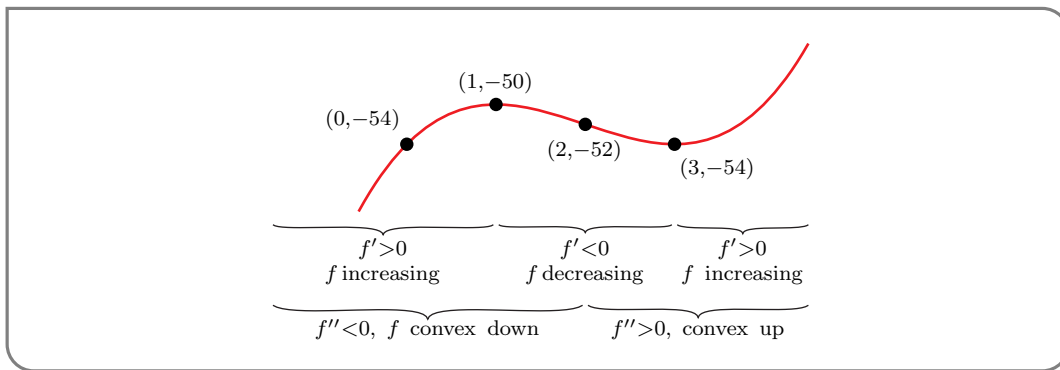

Example 7.6.3

An example of sketching a simple rational function.

Example 7.6.4 $\left(f(x) = \frac{x}{x^2 - 4} \right)$

(1) Reading from $f(x)$:

- The function is rational so it is defined except where its denominator is zero — namely at $x = \pm 2$.
- Since $f(-x) = \frac{-x}{x^2 - 4} = -f(x)$, it is odd. Indeed this means that we only need to examine what happens to the function for $x \geq 0$ and we can then infer what happens for $x \leq 0$ using $f(-x) = -f(x)$. In practice we will sketch the graph for $x \geq 0$ and then infer the rest from this symmetry.
- The y -intercept is $y = f(0) = 0$, while the x -intercepts are given by the solution of $f(x) = 0$. So the only x -intercept is 0.
- Since f is rational, it may have vertical asymptotes where its denominator is zero — at $x = \pm 2$. Since the function is odd, we only have to analyse the asymptote at $x = 2$ and we can then infer what happens at $x = -2$ by symmetry.

$$\lim_{x \rightarrow 2^+} f(x) = \lim_{x \rightarrow 2^+} \frac{x}{(x-2)(x+2)} = +\infty$$

$$\lim_{x \rightarrow 2^-} f(x) = \lim_{x \rightarrow 2^-} \frac{x}{(x-2)(x+2)} = -\infty$$

- We now check for horizontal asymptotes:

$$\begin{aligned} \lim_{x \rightarrow +\infty} f(x) &= \lim_{x \rightarrow +\infty} \frac{x}{x^2 - 4} \\ &= \lim_{x \rightarrow +\infty} \frac{1}{x - 4/x} = 0 \end{aligned}$$

(2) Now compute the derivative $f'(x)$:

$$\begin{aligned} f'(x) &= \frac{(x^2 - 4) \cdot 1 - x \cdot 2x}{(x^2 - 4)^2} \\ &= \frac{-(x^2 + 4)}{(x^2 - 4)^2} \end{aligned}$$

- Hence there are no critical points. There are singular points where the denominator is zero, namely $x = \pm 2$. Before we proceed, notice that the numerator is always negative and the denominator is always positive. Hence $f'(x) < 0$ except at $x = \pm 2$ where it is undefined.
- The function is decreasing except at $x = \pm 2$.
- We already know that at $x = 2$ we have a vertical asymptote and that $f'(x) < 0$ for all x . So

$$\lim_{x \rightarrow 2} f'(x) = -\infty$$

- Summarising all this

	$[0,2)$	2	$(2, \infty)$
$f'(x)$	negative	DNE	negative
	decreasing	vertical asymptote	decreasing

Remember — we will draw the graph for $x \geq 0$ and then use the odd symmetry to infer the graph for $x < 0$.

(3) Now examine $f''(x)$:

$$\begin{aligned} f''(x) &= -\frac{(x^2 - 4)^2 \cdot (2x) - (x^2 + 4) \cdot 2 \cdot 2x \cdot (x^2 - 4)}{(x^2 - 4)^4} \\ &= -\frac{(x^2 - 4) \cdot (2x) - (x^2 + 4) \cdot 4x}{(x^2 - 4)^3} \\ &= -\frac{2x^3 - 8x - 4x^3 - 16x}{(x^2 - 4)^3} \\ &= \frac{2x(x^2 + 12)}{(x^2 - 4)^3} \end{aligned}$$

- So $f''(x) = 0$ when $x = 0$ and does not exist when $x = \pm 2$. This splits the real line into the intervals $(-\infty, -2)$, $(-2, 0)$, $(0, 2)$ and $(2, \infty)$. However we only need to consider $x \geq 0$ (because of the odd symmetry).
- When $0 < x < 2$, $x > 0$, $(x^2 + 12) > 0$ and $(x^2 - 4) < 0$ so $f''(x) < 0$.
- When $x > 2$, $x > 0$, $(x^2 + 12) > 0$ and $(x^2 - 4) > 0$ so $f''(x) > 0$.

Putting all this information together gives the following sketch for $x \geq 0$:

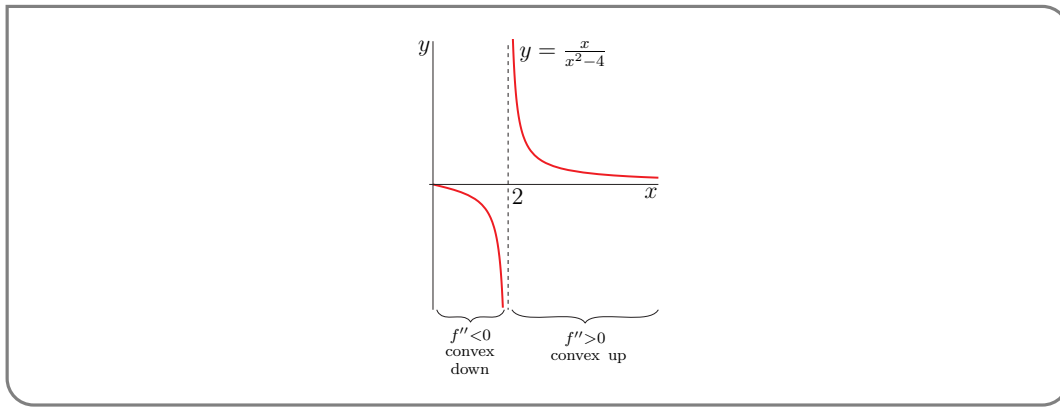

We can then draw in the graph for $x < 0$ using $f(-x) = -f(x)$:

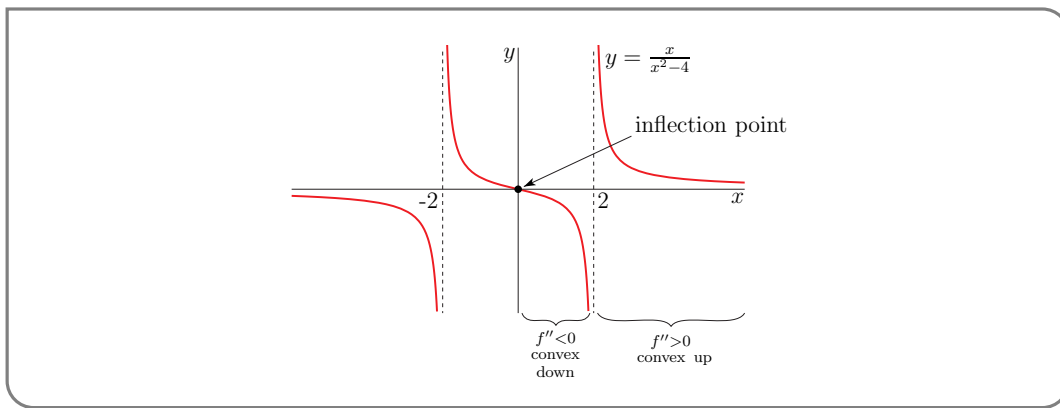

Notice that this means that the concavity changes at $x = 0$, so the point $(0, f(0)) = (0, 0)$ is a point of inflection (as indicated).

Example 7.6.4

This final example is more substantial since the function has singular points (points where the derivative is undefined). The analysis is more involved.

Example 7.6.5 $(f(x) = \sqrt[3]{\frac{x^2}{(x-6)^2}})$

(1) Reading from $f(x)$:

- First notice that we can rewrite

$$f(x) = \sqrt[3]{\frac{x^2}{(x-6)^2}} = \sqrt[3]{\frac{x^2}{x^2 \cdot (1-6/x)^2}} = \sqrt[3]{\frac{1}{(1-6/x)^2}}$$

- The function is the cube root of a rational function. The rational function is defined except at $x = 6$, so the domain of f is all reals except $x = 6$.

- Clearly the function is not periodic, and examining

$$\begin{aligned} f(-x) &= \sqrt[3]{\frac{1}{(1-6/(-x))^2}} \\ &= \sqrt[3]{\frac{1}{(1+6/x)^2}} \neq \pm f(x) \end{aligned}$$

shows the function is neither even nor odd.

- To compute horizontal asymptotes we examine the limit of the portion of the function inside the cube-root

$$\lim_{x \rightarrow \pm\infty} \frac{1}{(1-\frac{6}{x})^2} = 1$$

This means we have

$$\lim_{x \rightarrow \pm\infty} f(x) = 1$$

That is, the line $y = 1$ will be a horizontal asymptote to the graph $y = f(x)$ both for $x \rightarrow +\infty$ and for $x \rightarrow -\infty$.

- Our function $f(x) \rightarrow +\infty$ as $x \rightarrow 6$, because of the $(1-6/x)^2$ in its denominator. So $y = f(x)$ has $x = 6$ as a vertical asymptote.

(2) Now compute $f'(x)$. Since we rewrote

$$f(x) = \sqrt[3]{\frac{1}{(1-6/x)^2}} = \left(1 - \frac{6}{x}\right)^{-2/3}$$

we can use the chain rule

$$\begin{aligned} f'(x) &= -\frac{2}{3} \left(1 - \frac{6}{x}\right)^{-5/3} \frac{6}{x^2} \\ &= -4 \left(\frac{x-6}{x}\right)^{-5/3} \frac{1}{x^2} \\ &= -4 \left(\frac{1}{x-6}\right)^{5/3} \frac{1}{x^{1/3}} \end{aligned}$$

- Notice that the derivative is nowhere equal to zero, so the function has no critical points. However there are two places the derivative is undefined. The terms

$$\left(\frac{1}{x-6}\right)^{5/3} \qquad \frac{1}{x^{1/3}}$$

are undefined at $x = 6, 0$ respectively. Hence $x = 0, 6$ are singular points. These split the real line into the intervals $(-\infty, 0)$, $(0, 6)$ and $(6, \infty)$.

- When $x < 0$, $(x-6) < 0$, we have that $(x-6)^{-5/3} < 0$ and $x^{-1/3} < 0$ and so $f'(x) = -4 \cdot (\text{negative}) \cdot (\text{negative}) < 0$.

- When $0 < x < 6$, $(x - 6) < 0$, we have that $(x - 6)^{-5/3} < 0$ and $x^{-1/3} > 0$ and so $f'(x) > 0$.
- When $x > 6$, $(x - 6) > 0$, we have that $(x - 6)^{-5/3} > 0$ and $x^{-1/3} > 0$ and so $f'(x) < 0$.
- We should also examine the behaviour of the derivative as $x \rightarrow 0$ and $x \rightarrow 6$.

$$\begin{aligned} \lim_{x \rightarrow 0^-} f'(x) &= -4 \left(\lim_{x \rightarrow 0^-} (x - 6)^{-5/3} \right) \left(\lim_{x \rightarrow 0^-} x^{-1/3} \right) = -\infty \\ \lim_{x \rightarrow 0^+} f'(x) &= -4 \left(\lim_{x \rightarrow 0^+} (x - 6)^{-5/3} \right) \left(\lim_{x \rightarrow 0^+} x^{-1/3} \right) = +\infty \\ \lim_{x \rightarrow 6^-} f'(x) &= -4 \left(\lim_{x \rightarrow 6^-} (x - 6)^{-5/3} \right) \left(\lim_{x \rightarrow 6^-} x^{-1/3} \right) = +\infty \\ \lim_{x \rightarrow 6^+} f'(x) &= -4 \left(\lim_{x \rightarrow 6^+} (x - 6)^{-5/3} \right) \left(\lim_{x \rightarrow 6^+} x^{-1/3} \right) = -\infty \end{aligned}$$

We already know that $x = 6$ is a vertical asymptote of the function, so it is not surprising that the lines tangent to the graph become vertical as we approach 6. The behavior around $x = 0$ is less standard, since the lines tangent to the graph become vertical, but $x = 0$ is not a vertical asymptote of the function. Indeed the function takes a finite value $y = f(0) = 0$.

- Summarising all this

	$(-\infty, 0)$	0	(0,6)	6	$(6, \infty)$
$f'(x)$	negative	DNE	positive	DNE	negative
	decreasing	vertical tangents	increasing	vertical asymptote	decreasing

(3) Now look at $f''(x)$:

$$\begin{aligned} f''(x) &= -4 \frac{d}{dx} \left[\left(\frac{1}{x-6} \right)^{5/3} \frac{1}{x^{1/3}} \right] = -4 \left[-\frac{5}{3} \left(\frac{1}{x-6} \right)^{8/3} \frac{1}{x^{1/3}} - \frac{1}{3} \left(\frac{1}{x-6} \right)^{5/3} \frac{1}{x^{4/3}} \right] \\ &= \frac{4}{3} \left(\frac{1}{x-6} \right)^{8/3} \frac{1}{x^{4/3}} [5x + (x-6)] \\ &= 8 \left(\frac{1}{x-6} \right)^{8/3} \frac{1}{x^{4/3}} [x-1] \end{aligned}$$

Oof!

- Both of the factors $\left(\frac{1}{x-6} \right)^{8/3} = \left(\frac{1}{\sqrt[3]{x-6}} \right)^8$ and $\frac{1}{x^{4/3}} = \left(\frac{1}{\sqrt[3]{x}} \right)^4$ are even powers and so are positive (though possibly infinite). So the sign of $f''(x)$ is the same as the sign of the factor $x - 1$. Thus

	$(-\infty, 1)$	1	$(1, \infty)$
$f''(x)$	negative	0	positive
	concave down	inflection point	concave up

Here is a sketch of the graph $y = f(x)$.

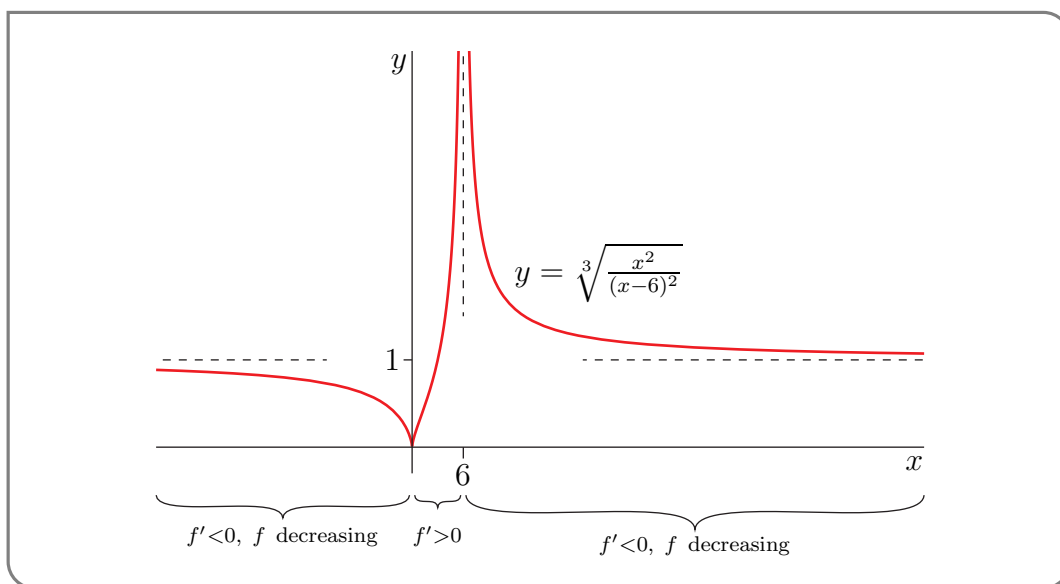

It is hard to see the inflection point at $x = 1, y = f(1) = \frac{1}{\sqrt[3]{25}}$ in the above sketch. So here is a blow up of the part of the sketch around $x = 1$.

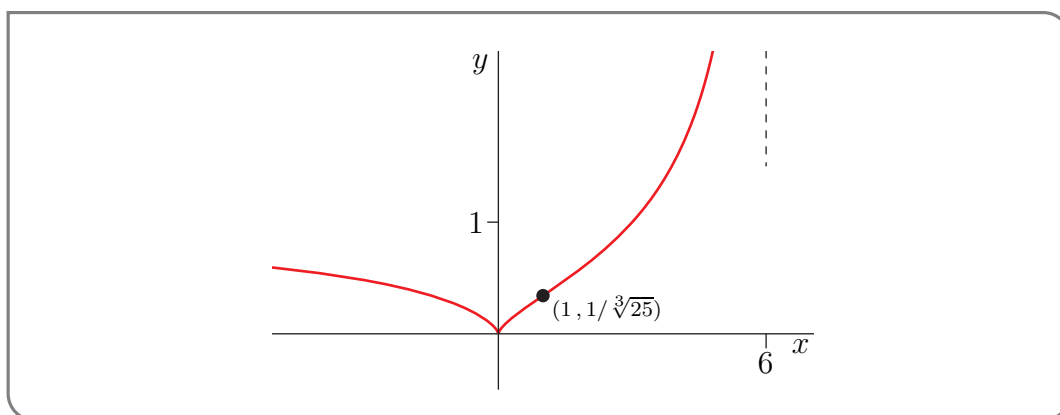

And if we zoom in even more we have

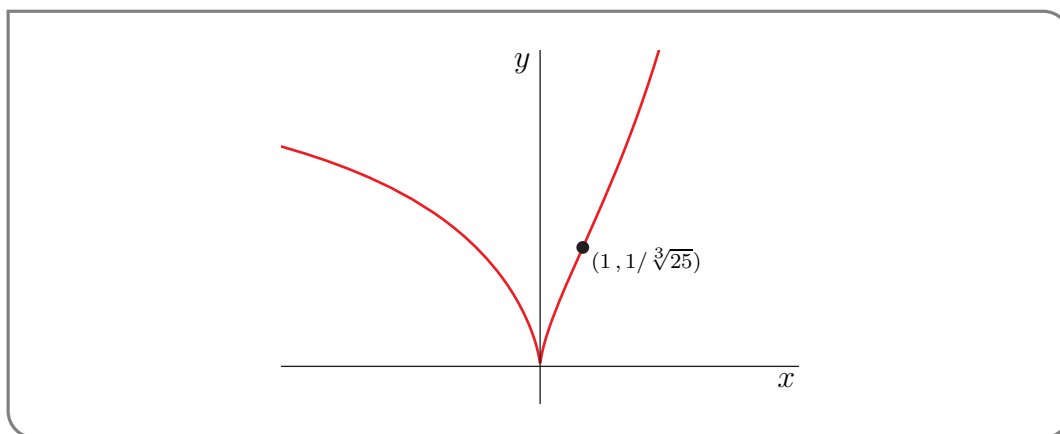

Example 7.6.5

OPTIMIZATION

Learning Objectives

- Determine the critical and singular points of a function.
- Identify local extrema of a function.
- Find the global extrema of a function on a closed interval.
- Explain how the algorithm can be used in optimization problems. (Note that finding a critical point is not enough to identify an extremum.)
- Convert geometric information into a function optimization problem.
- Interpret model optimization problems based on real-world examples according to their context.

One important application of differential calculus is to find the maximum (or minimum) value of a function. This often finds real world applications in problems such as the following.

Example 8.0.1

A farmer has 400m of fencing materials. What is the largest rectangular paddock that can be enclosed?

Solution. We will describe a general approach to these sorts of problems in Sections 8.2 and 8.3 below, but here we can take a stab at starting the problem.

- Begin by defining variables and their units (more generally we might draw a picture too); let the dimensions of the paddock be x by y metres.
- The area enclosed is then Am^2 where

$$A = x \cdot y$$

At this stage we cannot apply the calculus we have developed since the area is a function of two variables and we only know how to work with functions of a single variable. We need to eliminate one variable.

- We know that the perimeter of the rectangle (and hence the dimensions x and y) are constrained by the amount of fencing materials the farmer has to hand:

$$2x + 2y \leq 400$$

and so we have

$$y \leq 200 - x$$

Clearly the area of the paddock is maximised when we use all the fencing possible, so

$$y = 200 - x$$

- Now substitute this back into our expression for the area

$$A = x \cdot (200 - x)$$

Since the area cannot be negative (and our lengths x, y cannot be negative either), we must also have

$$0 \leq x \leq 200$$

- Thus the question of the largest paddock enclosed becomes the problem of finding the maximum value of

$$A = x \cdot (200 - x) \quad \text{subject to the constraint } 0 \leq x \leq 200.$$

Example 8.0.1

The above example is sufficiently simple that we can likely determine the answer by several different methods. In general, we will need more systematic methods for solving problems of the form

Find the maximum value of $y = f(x)$ subject to $a \leq x \leq b$

To do this we need to examine what a function looks like near its maximum and minimum values.

8.1 ▲ Local and global maxima and minima

We start by asking:

Suppose that the maximum (or minimum) value of $f(x)$ is $f(c)$. What does that tell us about c ?

Notice that we have not yet made the ideas of maximum and minimum very precise. For the moment think of maximum as “the biggest value” and minimum as “the smallest value”.

Warning 8.1.1.

It is important to distinguish between “the smallest value” and “the smallest magnitude”. For example, because

$$-5 < -1$$

the number -5 is smaller than -1 . But the magnitude of -1 , which is $|-1| = 1$, is smaller than the magnitude of -5 , which is $|-5| = 5$. Thus the smallest number in the set $\{-1, -5\}$ is -5 , while the number in the set $\{-1, -5\}$ that has the smallest magnitude is -1 .

Now back to thinking about what happens around a maximum. Suppose that the maximum value of $f(x)$ is $f(c)$, then for all “nearby” points, the function should be smaller.

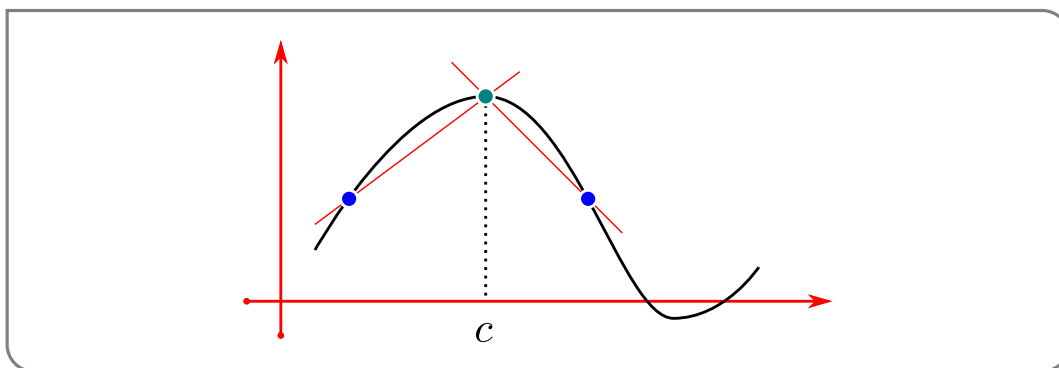

Consider the derivative of $f'(c)$:

$$f'(c) = \lim_{h \rightarrow 0} \frac{f(c+h) - f(c)}{h}.$$

Split the above limit into the left and right limits:

- Consider points to the right of $x = c$, For all $h > 0$,

$$\begin{aligned} f(c+h) &\leq f(c) && \text{which implies that} \\ f(c+h) - f(c) &\leq 0 && \text{which also implies} \\ \frac{f(c+h) - f(c)}{h} &\leq 0 && \text{since } \frac{\text{negative}}{\text{positive}} = \text{negative.} \end{aligned}$$

But now if we squeeze $h \rightarrow 0$ we get

$$\lim_{h \rightarrow 0^+} \frac{f(c+h) - f(c)}{h} \leq 0$$

(provided the limit exists).

- Consider points to the left of $x = c$. For all $h < 0$,

$$\begin{aligned} f(c+h) &\leq f(c) && \text{which implies that} \\ f(c+h) - f(c) &\leq 0 && \text{which also implies} \\ \frac{f(c+h) - f(c)}{h} &\geq 0 && \text{since } \frac{\text{negative}}{\text{negative}} = \text{positive.} \end{aligned}$$

But now if we squeeze $h \rightarrow 0$ we get

$$\lim_{h \rightarrow 0^-} \frac{f(c+h) - f(c)}{h} \geq 0$$

(provided the limit exists).

- So if the derivative $f'(c)$ exists, then the above right- and left-hand limits must agree, which forces $f'(c) = 0$.

Thus we can conclude that

If the maximum value of $f(x)$ is $f(c)$ and $f'(c)$ exists, then $f'(c) = 0$.

Using similar reasoning one can also see that

If the minimum value of $f(x)$ is $f(c)$ and $f'(c)$ exists, then $f'(c) = 0$.

Notice two things about the above reasoning:

- Firstly, in order for the argument to work we only need that $f(x) < f(c)$ for x close to c — it does not matter what happens for x values far from c .
- Secondly, in the above argument we needed to consider $f(x)$ for x both to the left of and to the right of c . If the function $f(x)$ is defined on a closed interval $[a, b]$, then the above argument only applies when $a < c < b$ — not when c is either of the endpoints a and b .

Consider the function below

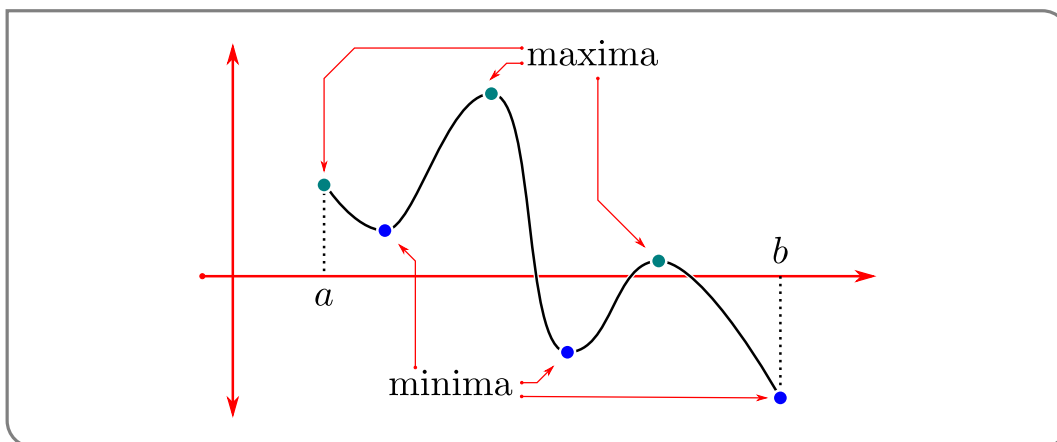

This function has only 1 maximum value (the middle green point in the graph) and 1 minimum value (the rightmost blue point), however it has 4 points at which the derivative is zero. In the small intervals around those points where the derivative is zero, we can see that function is *locally* a maximum or minimum, even if it is not the *global* maximum or minimum. We clearly need to be more careful distinguishing between these cases.

Definition 8.1.2.

Let I be an interval, like (a, b) or $[a, b]$ for example, and let the function $f(x)$ be defined for all $x \in I$. Now let $c \in I$. Then

- we say that $f(x)$ has a *global (or absolute) minimum on the interval I* at the point $x = c$ if $f(x) \geq f(c)$ for all $x \in I$.
- Similarly, we say that $f(x)$ has a *global (or absolute) maximum on I* at $x = c$ if $f(x) \leq f(c)$ for all $x \in I$.
- We say that $f(x)$ has a *local¹ minimum on I* at $x = c$ if $f(x) \geq f(c)$ for all $x \in I$ that are near c . Precisely, if there is a $\delta > 0$ such that $f(x) \geq f(c)$ for all $x \in I$ that are within a distance δ of c .
- Similarly, we say that $f(x)$ has a *local maximum on I* at $x = c$ if $f(x) \leq f(c)$ for all $x \in I$ that are near c . Precisely, if there is a $\delta > 0$ such that $f(x) \leq f(c)$ for all $x \in I$ that are within a distance δ of c .

The global maxima and minima of a function are called the global extrema of the function, while the local maxima and minima are called the local extrema.

Consider again the function we showed in the figure above

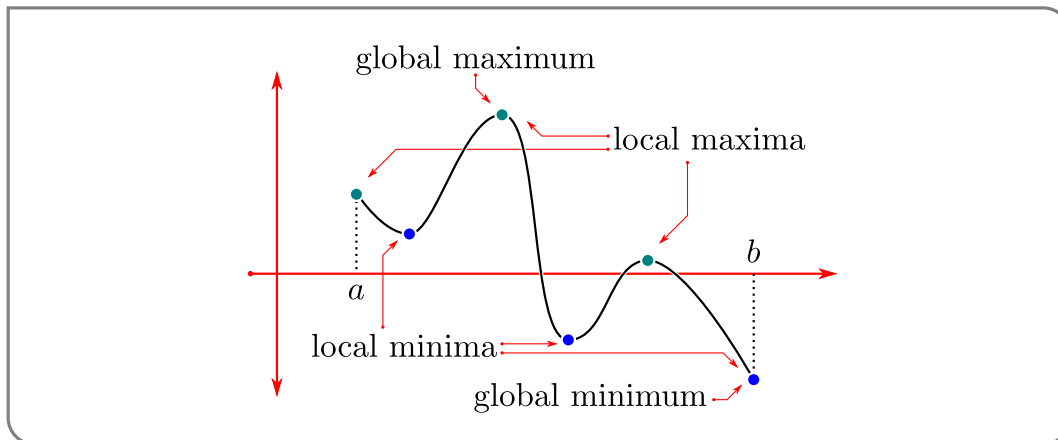

It has 3 local maxima and 3 local minima on the interval $[a, b]$. The global maximum occurs at the middle green point (which is also a local maximum), and the global minimum occurs at the rightmost blue point (which is also a local minimum).

Using the above definition we can summarise what we have learned above as the following theorem²:

- 1 Beware that, while many textbooks use these definitions of local minimum and maximum, some textbooks exclude the endpoints a, b of the interval $[a, b]$ from their definitions. Our definitions allow the endpoints a and b to be local minima and maxima. Note that, under our definitions, every global minimum (maximum) is also a local minimum (maximum).
- 2 This is one of several important mathematical contributions made by Pierre de Fermat, a French government lawyer and amateur mathematician, who lived in the first half of the seventeenth century.

Theorem 8.1.3.

Let the function $f(x)$ be defined on the interval I and let a, b, c be points in I with $a < c < b$. If $f(x)$ has a local maximum or local minimum at $x = c$ and if $f'(c)$ exists, then $f'(c) = 0$.

- It is often (but not always) the case that, when $f(x)$ has a local maximum at $x = c$, the function $f(x)$ increases strictly as x approaches c from the left and decreases strictly as x leaves c to the right. That is, $f'(x) > 0$ for x just to the left of c and $f'(x) < 0$ for x just to the right of c . Then, it is often the case, because $f'(x)$ is decreasing as x increases through c , that $f''(c) < 0$.
- Conversely, if $f'(c) = 0$ and $f''(c) < 0$, then, just to the right of c , $f'(x)$ must be negative, so that $f(x)$ is decreasing, and just to the left of c , $f'(x)$ must be positive, so that $f(x)$ is increasing. So $f(x)$ has a local maximum at c .
- Similarly, it is often the case that, when $f(x)$ has a local minimum at $x = c$, $f'(x) < 0$ for x just to the left of c and $f'(x) > 0$ for x just to the right of c and $f''(x) > 0$.
- Conversely, if $f'(c) = 0$ and $f''(c) > 0$, then, just to the right of c , $f'(x)$ must be positive, so that $f(x)$ is increasing, and, just to the left of c , $f'(x)$ must be negative, so that $f(x)$ is decreasing. So $f(x)$ has a local minimum at c .

Theorem 8.1.4 (Second Derivative Test).

Let $f(x)$ be defined on the interval I and let $a, b, c \in I$ with $a < c < b$.

If $f'(c) = 0$ and $f''(c) < 0$, then $f(x)$ has a local maximum at c .

If $f'(c) = 0$ and $f''(c) > 0$, then $f(x)$ has a local minimum at c .

Note the strict inequalities.

Theorem 8.1.3 says that, when $f(x)$ has a local maximum or minimum on an interval I at the point $x = c$, there are three possibilities.

- The derivative $f'(c) = 0$. This case is illustrated in the following figure.

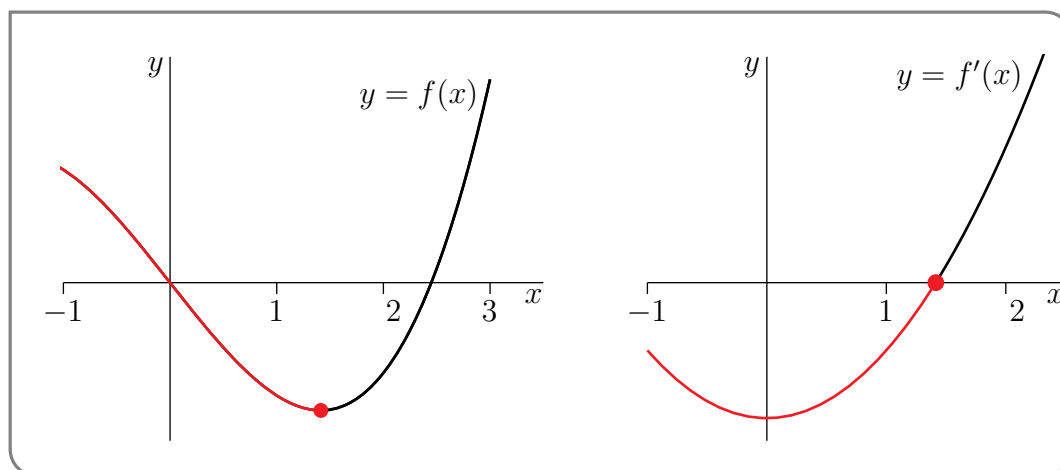

Observe that, in this example, $f'(x)$ changes continuously from negative to positive at the local minimum, taking the value zero at the local minimum (the red dot).

- The derivative $f'(c)$ does not exist. This case is illustrated in the following figure.

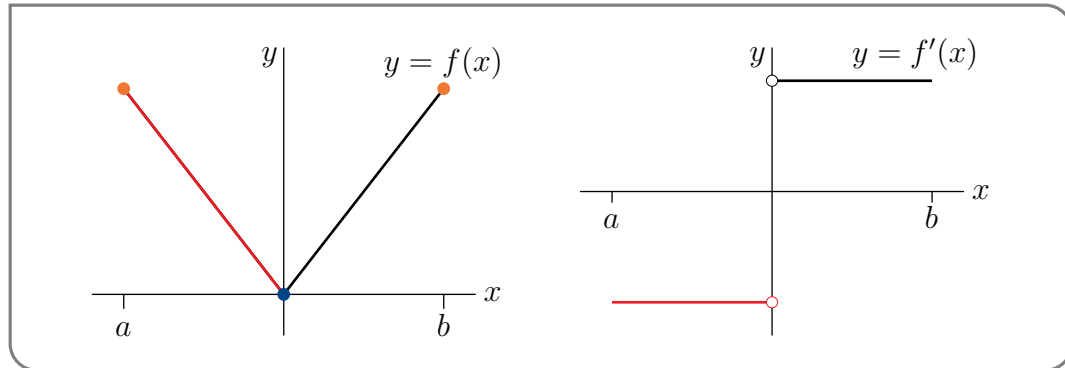

Observe that, in this example, $f'(x)$ changes discontinuously from negative to positive at the local minimum ($x = 0$) and $f'(0)$ does not exist.

- The point c is an endpoint of the interval $I = [a, b]$. This case is also illustrated in the above figure. The endpoints a and b are both local maxima. But $f'(a)$ and $f'(b)$ are not zero.

This theorem demonstrates that the points at which the derivative is zero or does not exist are very important. Recall the definitions of critical point and singular point from Definition 7.2.1.

We'll now look at a few simple examples involving local maxima and minima, critical points and singular points. Then we will move on to global maxima and minima.

Example 8.1.5

In this example, we'll look for local maxima and minima of the function $f(x) = x^3 - 6x$ on the interval $-2 \leq x \leq 3$.

- First compute the derivative

$$f'(x) = 3x^2 - 6.$$

Since this is a polynomial it is defined everywhere on the domain and so there will not be any singular points. So we now look for critical points.

- To do so we look for zeroes of the derivative

$$f'(x) = 3x^2 - 6 = 3(x^2 - 2) = 3(x - \sqrt{2})(x + \sqrt{2}).$$

This derivative takes the value 0 at two different values of x . Namely $x = c_- = -\sqrt{2}$ and $x = c_+ = \sqrt{2}$. Here is a sketch of the graph of $f(x)$.

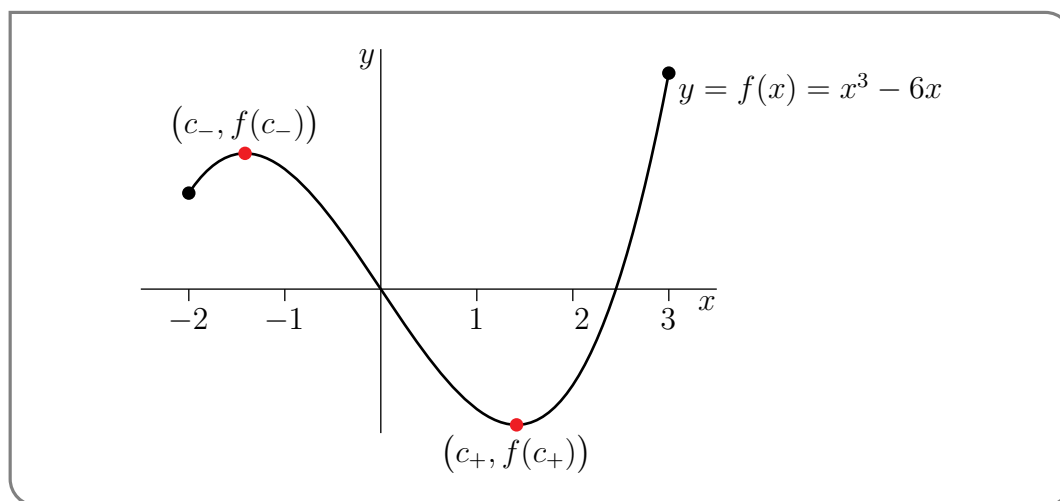

From the figure we see that

- $f(x)$ has a local minimum at the endpoint $x = -2$ (i.e. we have $f(x) \geq f(-2)$ whenever $x \geq -2$ is close to -2) and
 - $f(x)$ has a local minimum at $x = c_+$ (i.e. we have $f(x) \geq f(c_+)$ whenever x is close to c_+) and
 - $f(x)$ has a local maximum at $x = c_-$ (i.e. we have $f(x) \leq f(c_-)$ whenever x is close to c_-) and
 - $f(x)$ has a local maximum at the endpoint $x = 3$ (i.e. we have $f(x) \leq f(3)$ whenever $x \leq 3$ is close to 3) and
 - the global minimum of $f(x)$, for x in the interval $-2 \leq x \leq 3$, is at $x = c_+$ (i.e. we have $f(x) \geq f(c_+)$ whenever $-2 \leq x \leq 3$) and
 - the global maximum of $f(x)$, for x in the interval $-2 \leq x \leq 3$, is at $x = 3$ (i.e. we have $f(x) \leq f(3)$ whenever $-2 \leq x \leq 3$).
- Note that we have carefully constructed this example to illustrate that the global maximum (or minimum) of a function on an interval may or may not also be a critical point of the function.

Example 8.1.5

Example 8.1.6

In this example, we'll look for local maxima and minima of the function $f(x) = x^3$ on the interval $-1 < x < 1$.

- First compute the derivative:

$$f'(x) = 3x^2.$$

Again, this is a polynomial and so defined on all of the domain. The function will not have singular points, but may have critical points.

- The derivative is zero only when $x = 0$, so $x = c = 0$ is the only critical point of the function.

- The graph of $f(x)$ is sketched below. From that sketch we see that $f(x)$ has *neither* a local maximum *nor* a local minimum at $x = c$ despite the fact that $f'(c) = 0$ — we have $f(x) < f(c) = 0$ for all $x < c = 0$ and $f(x) > f(c) = 0$ for all $x > c = 0$.

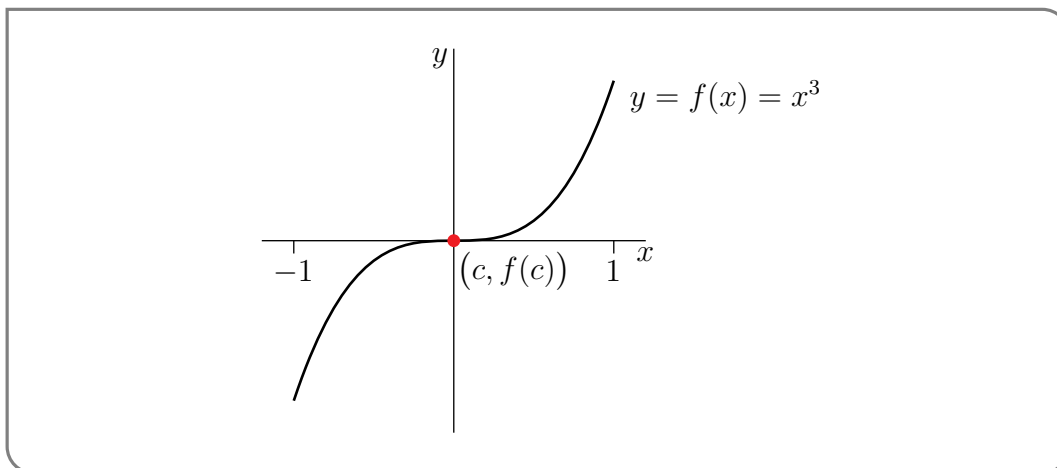

- Note that this example has been constructed to illustrate that a critical point (or singular point) of a function *need not be a local maximum or minimum* for the function.
- Reread Theorem 8.1.3. It says³ “Let \dots . If $f(x)$ has a local maximum/minimum at $x = c$ and if $f'(c)$ exists, then $f'(c) = 0$ ”. It *does not say* that “if $f'(c) = 0$ then f has a local maximum/minimum at $x = c$ ”.

Example 8.1.6

Example 8.1.7

In this example, we'll look for local maxima and minima of the function

$$f(x) = |x| = \begin{cases} x & \text{if } x \geq 0 \\ -x & \text{if } x < 0 \end{cases}$$

on the interval $-1 < x < 1$ and we'll also look for local maxima and minima of the function

$$g(x) = x^{2/3}$$

on the interval $-1 < x < 1$.

- Again, start by computing the derivatives (reread Example 3.3.15):

$$f'(x) = \begin{cases} 1 & \text{if } x > 0 \\ \text{undefined} & \text{if } x = 0 \\ -1 & \text{if } x < 0 \end{cases}$$

$$g'(x) = \begin{cases} \frac{2}{3}x^{-1/3} & \text{if } x \neq 0 \\ \text{undefined} & \text{if } x = 0 \end{cases}$$

3 A very common error of logic that people make is “Affirming the consequent”. When the statement “if P then Q” is true, observing Q does *not* imply P. (“Affirming the consequent” eliminates “not” from the previous sentence.) For example, “If he is Shakespeare, then he is dead,” and “That man is dead.” does not imply “He must be Shakespeare.”. Or you may have also seen someone use this reasoning: “If a person is a genius before their time then they are misunderstood.” “I am misunderstood.” “So I must be a genius before my time.”.

- These derivatives *never* take the value 0, so the functions $f(x)$ and $g(x)$ do not have any critical points. However both derivatives do not exist at the point $x = 0$, so that point is a singular point for both $f(x)$ and $g(x)$.
- Here is a sketch of the graph of $f(x)$

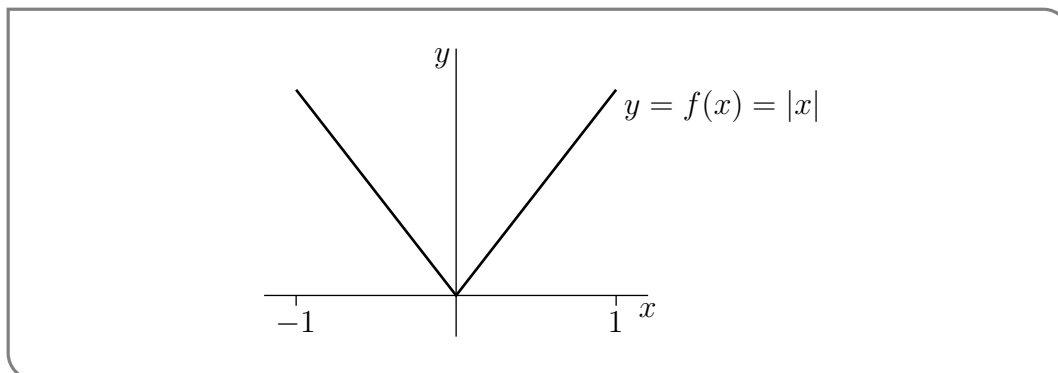

and a sketch of the graph of $g(x)$.

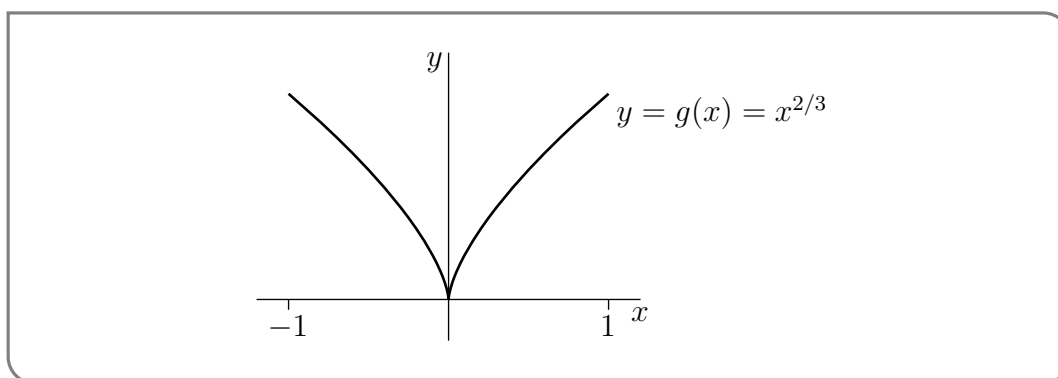

From the figures we see that both $f(x)$ and $g(x)$ have a local (and in fact global) minimum at $x = 0$ despite the fact that $x = 0$ is not a critical point.

- Reread Theorem 8.1.3 yet again. It says “Let \dots . If $f(x)$ has a local maximum or local minimum at $x = c$ and if f is differentiable at $x = c$, then $f'(c) = 0$ ”. It says nothing about what happens at points where the derivative does not exist. Indeed that is why we have to consider both critical points and singular points when we look for maxima and minima.

Example 8.1.7

8.2 ▲ Finding global maxima and minima

We now have a technique for finding local maxima and minima — just look at endpoints of the interval of interest and for values of x for which either $f'(x) = 0$ or $f'(x)$ does not exist. What about finding global maxima and minima? We'll start by stating explicitly that, under appropriate hypotheses, global maxima and minima are guaranteed to exist.

Theorem 8.2.1.

Let the function $f(x)$ be defined and continuous on the closed, finite interval⁴ $-\infty < a \leq x \leq b < \infty$. Then $f(x)$ attains a maximum and a minimum at least once. That is, there exist numbers $a \leq x_m, x_M \leq b$ such that

$$f(x_m) \leq f(x) \leq f(x_M) \quad \text{for all } a \leq x \leq b$$

So let's again consider the question

Suppose that the maximum (or minimum) value of $f(x)$, for $a \leq x \leq b$, is $f(c)$. What does that tell us about c ?

If c obeys $a < c < b$ (note the strict inequalities), then f has a local maximum (or minimum) at $x = c$ and Theorem 8.1.3 tells us that either $f'(c) = 0$ or $f'(c)$ does not exist. The only other place that a maximum or minimum can occur are at the ends of the interval. We can summarise this as:

Theorem 8.2.2.

If $f(x)$ has a global maximum or global minimum, for $a \leq x \leq b$, at $x = c$ then there are 3 possibilities. Either

- $f'(c) = 0$, or
- $f'(c)$ does not exist, or
- $c = a$ or $c = b$.

That is, a global maximum or minimum must occur either at a critical point, a singular point or at the endpoints of the interval.

This theorem provides the basis for a method to find the maximum and minimum values of $f(x)$ for $a \leq x \leq b$:

4 The hypotheses that $f(x)$ be continuous and that the interval be finite and closed are all essential. We suggest that you find three functions $f_1(x)$, $f_2(x)$ and $f_3(x)$ with f_1 defined but not continuous on $0 \leq x \leq 1$, f_2 defined and continuous on $-\infty < x < \infty$, and f_3 defined and continuous on $0 < x < 1$, and with none of f_1 , f_2 and f_3 attaining either a global maximum or a global minimum.

Corollary 8.2.3.

Let $f(x)$ be a function on the interval $a \leq x \leq b$. Then to find the global maximum and minimum of the function:

- Make a list of all values of c , with $a \leq c \leq b$, for which
 - $f'(c) = 0$, or
 - $f'(c)$ does not exist, or
 - $c = a$ or $c = b$.

That is — compute the function at all the critical points, singular points, and endpoints.

- Evaluate $f(c)$ for each c in that list. The largest (or smallest) of those values is the largest (or smallest) value of $f(x)$ for $a \leq x \leq b$.

Let's now demonstrate how to use this strategy. The function in this first example is not too simple — but it is a good example of a function that contains both a singular point and a critical point.

Example 8.2.4

Find the largest and smallest values of the function $f(x) = 2x^{5/3} + 3x^{2/3}$ for $-1 \leq x \leq 1$.

Solution. We will apply the method in Corollary 8.2.3. It is perhaps easiest to find the values at the endpoints of the intervals and then move on to the values at any critical or singular points.

- Before we get into things, notice that we can rewrite the function by factoring it:

$$f(x) = 2x^{5/3} + 3x^{2/3} = x^{2/3} \cdot (2x + 3)$$

- Let's compute the function at the endpoints of the interval:

$$\begin{aligned} f(1) &= 2 + 3 = 5 \\ f(-1) &= 2 \cdot (-1)^{5/3} + 3 \cdot (-1)^{2/3} = -2 + 3 = 1 \end{aligned}$$

- To compute the function at the critical and singular points we first need to find the derivative:

$$\begin{aligned} f'(x) &= 2 \cdot \frac{5}{3}x^{2/3} + 3 \cdot \frac{2}{3}x^{-1/3} \\ &= \frac{10}{3}x^{2/3} + 2x^{-1/3} \\ &= \frac{10x + 6}{3x^{1/3}} \end{aligned}$$

- Notice that the numerator and denominator are defined for all x . The only place the derivative is undefined is when the denominator is zero. Hence the only singular point is at $x = 0$. The corresponding function value is

$$f(0) = 0$$

- To find the critical points we need to solve $f'(x) = 0$:

$$0 = \frac{10x + 6}{3x^{1/3}}$$

Hence we must have $10x = -6$ or $x = -3/5$. The corresponding function value is

$$\begin{aligned} f(x) &= x^{2/3} \cdot (2x + 3) && \text{recall this from above, then} \\ f(-3/5) &= (-3/5)^{2/3} \cdot \left(2 \cdot \frac{-3}{5} + 3\right) \\ &= \left(\frac{9}{25}\right)^{1/3} \cdot \frac{-6 + 15}{5} \\ &= \left(\frac{9}{25}\right)^{1/3} \cdot \frac{9}{5} \approx 1.28 \end{aligned}$$

Note that if we do not want to approximate the root (if, for example, we do not have a calculator handy), then we can also write

$$\begin{aligned} f(-3/5) &= \left(\frac{9}{25}\right)^{1/3} \cdot \frac{9}{5} \\ &= \left(\frac{9}{25}\right)^{1/3} \cdot \frac{9}{25} \cdot 5 \\ &= 5 \cdot \left(\frac{9}{25}\right)^{4/3} \end{aligned}$$

Since $0 < 9/25 < 1$, we know that $0 < \left(\frac{9}{25}\right)^{4/3} < 1$, and hence

$$0 < f(-3/5) = 5 \cdot \left(\frac{9}{25}\right)^{4/3} < 5.$$

- We summarise our work in this table

c	$-\frac{3}{5}$	0	-1	1
type	critical point	singular point	endpoint	endpoint
$f(c)$	$\frac{9}{5} \sqrt[3]{\frac{9}{25}} \approx 1.28$	0	1	5

- The largest value of f in the table is 5 and the smallest value of f in the table is 0.
- Thus on the interval $-1 \leq x \leq 1$ the global maximum of f is 5, and is taken at $x = 1$, while the global minimum value of $f(x)$ is 0, and is taken at $x = 0$.
- For completeness we also sketch the graph of this function on the same interval.

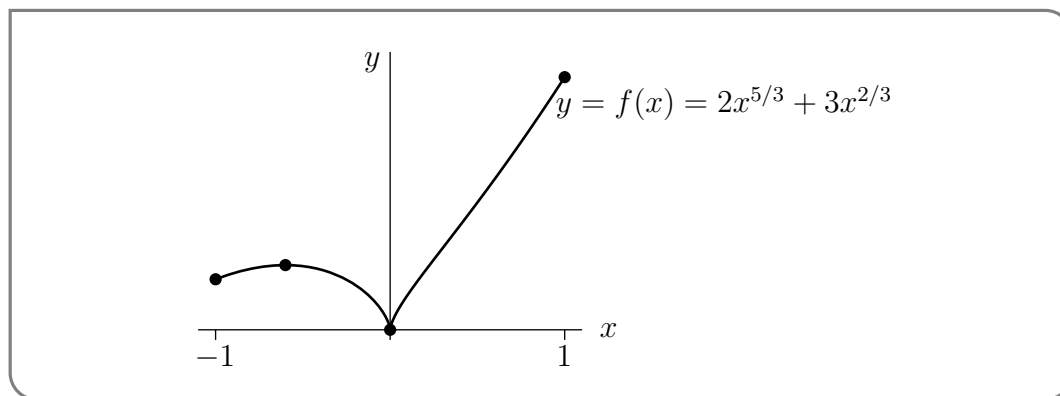

Later (in Section 7) we will see how to construct such a sketch without using a calculator or computer.

Example 8.2.4

8.3 ▲ Max/min examples

As noted at the beginning of this section, the problem of finding maxima and minima is a very important application of differential calculus in the real world. We now turn to a number of examples of this process. But to guide the reader we will describe a general procedure to follow for these problems.

- (1) Read — read the problem carefully. Work out what information is given in the statement of the problem and what we are being asked to compute.
- (2) Diagram — draw a diagram. This will typically help you to identify what you know about the problem and what quantities you need to work out.
- (3) Variables — assign variables to the quantities in the problem along with their units. It is typically a good idea to make sensible choices of variable names: A for area, h for height, t for time etc.
- (4) Relations — find relations between the variables. By now you should know the quantity we are interested in (the one we want to maximise or minimise) and we need to establish a relation between it and the other variables.
- (5) Reduce — the relation down to a function of one variable. In order to apply the calculus we know, we must have a function of a single variable. To do this we need to use all the information we have to eliminate variables. We should also work out the domain of the resulting function.
- (6) Maximise or minimise — we can now apply the methods of Corollary 8.2.3 to find the maximum or minimum of the quantity we need (as the problem dictates).
- (7) Be careful — make sure your answer makes sense. Make sure quantities are physical. For example, lengths and areas cannot be negative.
- (8) Answer the question — be sure your answer really answers the question asked in the problem.

Let us start with a relatively simple problem:

Example 8.3.1

A closed rectangular container with a square base is to be made from two different materials. The material for the base costs \$5 per square meter, while the material for the other five sides costs \$1 per square meter. Find the dimensions of the container which has the largest possible volume if the total cost of materials is \$72.

Solution. We can follow the steps we outlined above to find the solution.

- We need to determine the area of the two types of materials used and the corresponding total cost.
- Draw a picture of the box.

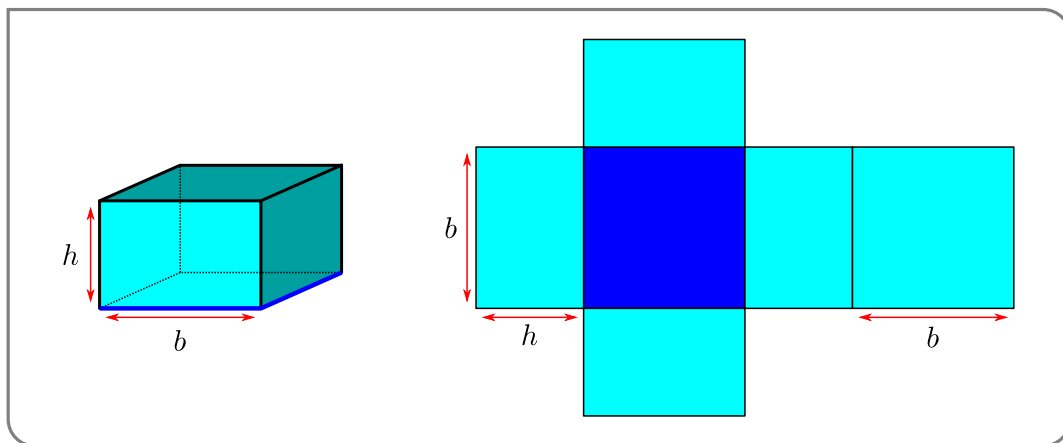

The more useful picture is the unfolded box on the right.

- In the picture we have already introduced two variables. The square base has side-length b metres and it has height h metres. Let the area of the base be A_b and the area of the other five sides be A_s (both in m^2), and the total cost be C (in dollars). Finally let the volume enclosed be Vm^3 .
- Some simple geometry tells us that

$$A_b = b^2$$

$$A_s = 4bh + b^2$$

$$V = b^2h$$

$$C = 5 \cdot A_b + 1 \cdot A_s = 5b^2 + 4bh + b^2 = 6b^2 + 4bh.$$

- To eliminate one of the variables we use the fact that the total cost is \$72.

$$C = 6b^2 + 4bh = 72 \quad \text{rearrange}$$

$$4bh = 72 - 6b^2 \quad \text{isolate } h$$

$$h = \frac{72 - 6b^2}{4b} = \frac{3}{2} \cdot \frac{12 - b^2}{b}$$

Substituting this into the volume gives

$$V = b^2h = \frac{3b}{2}(12 - b^2) = 18b - \frac{3}{2}b^3$$

Now note that since b is a length it cannot be negative, so $b \geq 0$. Further since volume cannot be negative, we must also have

$$12 - b^2 \geq 0$$

and so $b \leq \sqrt{12}$.

- Now we can apply Corollary 8.2.3 on the above expression for the volume with $0 \leq b \leq \sqrt{12}$. The endpoints give:

$$\begin{aligned} V(0) &= 0 \\ V(\sqrt{12}) &= 0 \end{aligned}$$

The derivative is

$$V'(b) = 18 - \frac{9b^2}{2}$$

Since this is a polynomial there are no singular points. However we can solve $V'(b) = 0$ to find critical points:

$$\begin{aligned} 18 - \frac{9b^2}{2} &= 0 && \text{divide by 9 and multiply by 2} \\ 4 - b^2 &= 0 \end{aligned}$$

Hence $b = \pm 2$. Thus the only critical point in the domain is $b = 2$. The corresponding volume is

$$\begin{aligned} V(2) &= 18 \times 2 - \frac{3}{2} \times 2^3 \\ &= 36 - 12 = 24. \end{aligned}$$

So by Corollary 8.2.3, the maximum volume is when 24 when $b = 2$ and

$$h = \frac{3}{2} \cdot \frac{12 - b^2}{b} = \frac{3}{2} \frac{12 - 4}{2} = 6.$$

- All our quantities make sense; lengths, areas and volumes are all non-negative.
- Checking the question again, we see that we are asked for the dimensions of the container (rather than its volume) so we can answer with

The container with dimensions $2 \times 2 \times 6m$ will be the largest possible.

Example 8.3.1

Example 8.3.2

A rectangular sheet of cardboard is 6 inches by 9 inches. Four identical squares are cut from the corners of the cardboard, as shown in the figure below, and the remaining piece is folded into an open rectangular box. What should the size of the cut out squares be in order to maximize the volume of the box?

Solution. This one is quite similar to the previous one, so we perhaps don't need to go into so much detail.

- After reading carefully we produce the following picture:

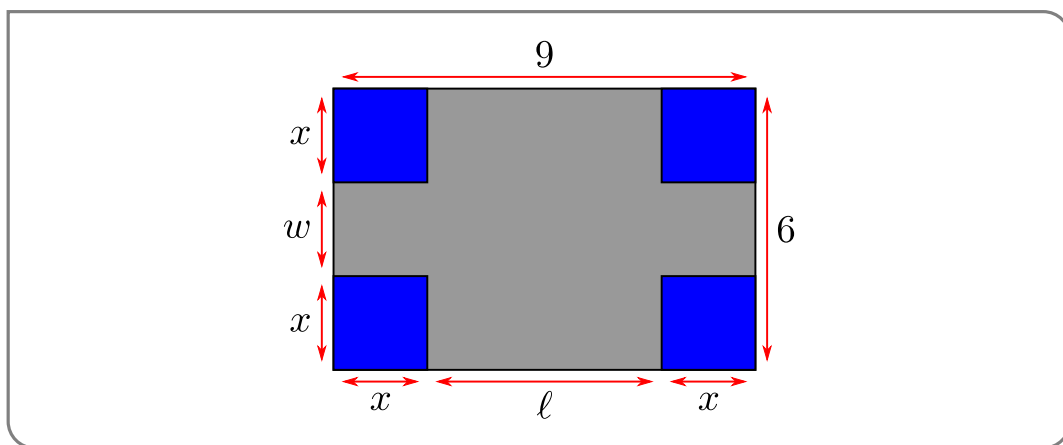

- Let the height of the box be x inches, and the base be $\ell \times w$ inches. The volume of the box is then V cubic inches.
- Some simple geometry tells us that $\ell = 9 - 2x$, $w = 6 - 2x$ and so

$$\begin{aligned} V &= x(9 - 2x)(6 - 2x) \text{ cubic inches} \\ &= 54x - 30x^2 + 4x^3. \end{aligned}$$

Notice that since all lengths must be non-negative, we must have

$$x, \ell, w \geq 0$$

and so $0 \leq x \leq 3$ (if $x > 3$ then $w < 0$).

- We can now apply Corollary 8.2.3. First the endpoints of the interval give

$$V(0) = 0 \qquad V(3) = 0$$

The derivative is

$$\begin{aligned} V'(x) &= 54 - 60x + 12x^2 \\ &= 6(9 - 10x + 2x^2) \end{aligned}$$

Since this is a polynomial there are no singular points. To find critical points we solve $V'(x) = 0$ to get

$$\begin{aligned} x_{\pm} &= \frac{10 \pm \sqrt{100 - 4 \times 2 \times 9}}{4} \\ &= \frac{10 \pm \sqrt{28}}{4} = \frac{10 \pm 2\sqrt{7}}{4} = \frac{5 \pm \sqrt{7}}{2} \end{aligned}$$

We can then use a calculator to approximate

$$x_+ \approx 3.82 \qquad x_- \approx 1.18.$$

So x_- is inside the domain, while x_+ lies outside.

Alternatively⁵, we can bound x_{\pm} by first noting that $2 \leq \sqrt{7} \leq 3$. From this we know that

$$\begin{aligned} 1 &= \frac{5-3}{2} \leq x_- = \frac{5-\sqrt{7}}{2} \leq \frac{5-2}{2} = 1.5 \\ 3.5 &= \frac{5+2}{2} \leq x_+ = \frac{5+\sqrt{7}}{2} \leq \frac{5+3}{2} = 4 \end{aligned}$$

- Since the volume is zero when $x = 0, 3$, it must be the case that the volume is maximised when $x = x_- = \frac{5-\sqrt{7}}{2}$.
- Notice that since $0 < x_- < 3$ we know that the other lengths are positive, so our answer makes sense. Further, the question only asks for the length x and not the resulting volume so we have answered the question.

Example 8.3.2

There is a new wrinkle in the next two examples. Each involves finding the minimum value of a function $f(x)$ with x running over all real numbers, rather than just over a finite interval as in Corollary 8.2.3. Both in Example 8.3.4 and in Example 8.3.5 the function $f(x)$ tends to $+\infty$ as x tends to either $+\infty$ or $-\infty$. So the minimum value of $f(x)$ will be achieved for some finite value of x , which will be a local minimum as well as a global minimum.

⁵ Say if we do not have a calculator to hand, or your instructor insists that the problem be done without one.

Theorem 8.3.3.

Let $f(x)$ be defined and continuous for all $-\infty < x < \infty$. Let c be a finite real number.

(a) If $\lim_{x \rightarrow +\infty} f(x) = +\infty$ and $\lim_{x \rightarrow -\infty} f(x) = +\infty$ and if $f(x)$ has a global minimum at $x = c$, then there are 2 possibilities. Either

- $f'(c) = 0$, or
- $f'(c)$ does not exist

That is, a global minimum must occur either at a critical point or at a singular point.

(b) If $\lim_{x \rightarrow +\infty} f(x) = -\infty$ and $\lim_{x \rightarrow -\infty} f(x) = -\infty$ and if $f(x)$ has a global maximum at $x = c$, then there are 2 possibilities. Either

- $f'(c) = 0$, or
- $f'(c)$ does not exist

That is, a global maximum must occur either at a critical point or at a singular point.

Example 8.3.4

Find the point on the line $y = 6 - 3x$ that is closest to the point $(7, 5)$.

Solution. In this problem

- A simple picture

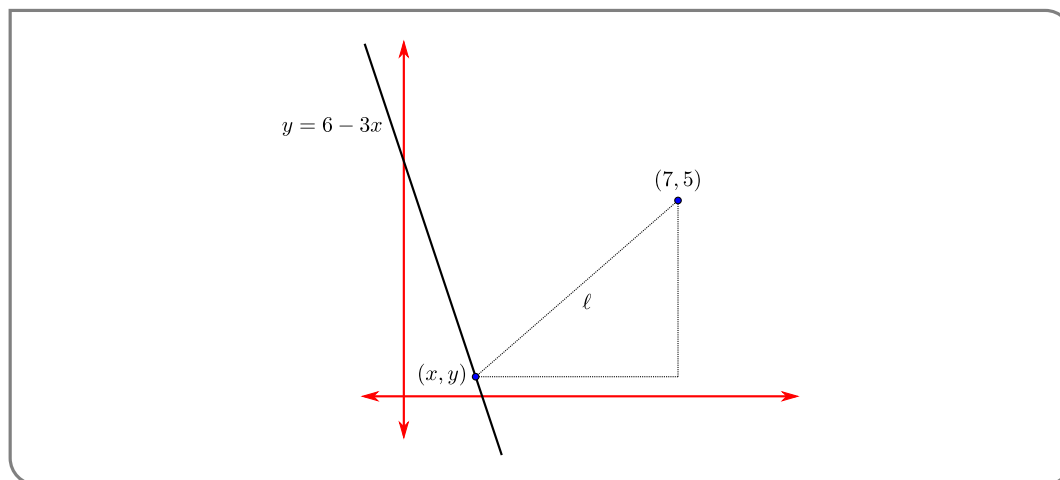

- Some notation is already given to us. Let a point on the line have coordinates (x, y) , and we do not need units. And let ℓ be the distance from the point (x, y) to the point $(7, 5)$.
- Since the points are on the line the coordinates (x, y) must obey

$$y = 6 - 3x$$

Notice that x and y have no further constraints. The distance ℓ is given by

$$\ell^2 = (x-7)^2 + (y-5)^2$$

- We can now eliminate the variable y :

$$\begin{aligned}\ell^2 &= (x-7)^2 + (y-5)^2 \\ &= (x-7)^2 + (6-3x-5)^2 = (x-7)^2 + (1-3x)^2 \\ &= x^2 - 14x + 49 + 1 - 6x + 9x^2 = 10x^2 - 20x + 50 \\ &= 10(x^2 - 2x + 5) \\ \ell &= \sqrt{10} \cdot \sqrt{x^2 - 2x + 5}\end{aligned}$$

Notice that as $x \rightarrow \pm\infty$ the distance $\ell \rightarrow +\infty$.

- We can now apply Theorem 8.3.3
 - Since the distance is defined for all real x , we do not have to check the endpoints of the domain — there are none.
 - Form the derivative:

$$\frac{d\ell}{dx} = \sqrt{10} \frac{2x-2}{2\sqrt{x^2-2x+5}}$$

It is zero when $x = 1$, and undefined if $x^2 - 2x + 5 < 0$. However, since

$$x^2 - 2x + 5 = (x^2 - 2x + 1) + 4 = \underbrace{(x-1)^2}_{\geq 0} + 4$$

we know that $x^2 - 2x + 5 \geq 4$. Thus the function has no singular points and the only critical point occurs at $x = 1$. The corresponding function value is then

$$\ell(1) = \sqrt{10}\sqrt{1-2+5} = 2\sqrt{10}.$$

- Thus the minimum value of the distance is $\ell = 2\sqrt{10}$ and occurs at $x = 1$.
- This answer makes sense — the distance is not negative.
- The question asks for the point that minimises the distance, not that minimum distance. Hence the answer is $x = 1, y = 6 - 3 = 3$. I.e.

The point that minimises the distance is $(1, 3)$.

Notice that we can make the analysis easier by observing that the point that minimises the distance also minimises the squared-distance. So that instead of minimising the function ℓ , we can just minimise ℓ^2 :

$$\ell^2 = 10(x^2 - 2x + 5)$$

The resulting algebra is a bit easier and we don't have to hunt for singular points.

Example 8.3.4

Example 8.3.5

Find the minimum distance from $(2,0)$ to the curve $y^2 = x^2 + 1$.

Solution. This is very much like the previous question.

- After reading the problem carefully we can draw a picture

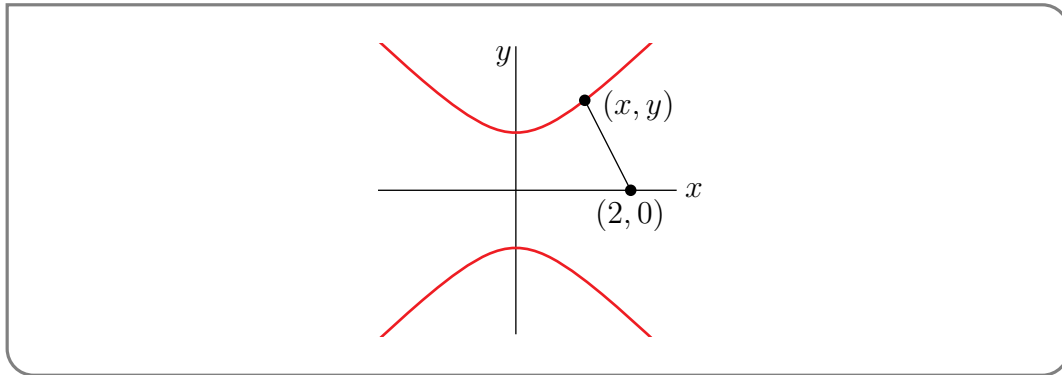

- In this problem we do not need units and the variables x, y are supplied. We define the distance to be ℓ and it is given by

$$\ell^2 = (x-2)^2 + y^2.$$

As noted in the previous problem, we will minimise the squared-distance since that also minimises the distance.

- Since x, y satisfy $y^2 = x^2 + 1$, we can write the distance as a function of x :

$$\ell^2 = (x-2)^2 + y^2 = (x-2)^2 + (x^2 + 1)$$

Notice that as $x \rightarrow \pm\infty$ the squared-distance $\ell^2 \rightarrow +\infty$.

- Since the squared-distance is a polynomial it will not have any singular points, only critical points. The derivative is

$$\frac{d}{dx}\ell^2 = 2(x-2) + 2x = 4x - 4$$

so the only critical point occurs at $x = 1$.

- When $x = 1, y = \pm\sqrt{2}$ and the distance is

$$\ell^2 = (1-2)^2 + (1+1) = 3 \qquad \ell = \sqrt{3}$$

and thus the minimum distance from the curve to $(2,0)$ is $\sqrt{3}$.

Example 8.3.5

Example 8.3.6

A water trough is to be constructed from a metal sheet of width 45 cm by bending up one third of the sheet on each side through an angle θ . Which θ will allow the trough to carry the maximum amount of water?

Solution. Clearly $0 \leq \theta \leq \pi$, so we are back in the domain⁶ of Corollary 8.2.3.

- After reading the problem carefully we should realise that it is really asking us to maximise the cross-sectional area. A figure really helps.

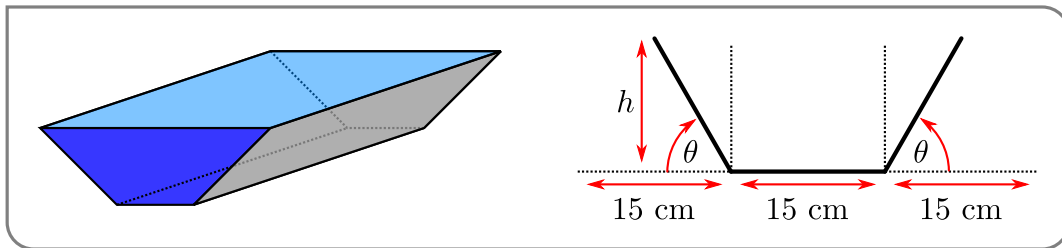

- From this we are led to define the height h cm and cross-sectional area A cm^2 . Both are functions of θ .

$$h = 15 \sin \theta$$

while the area can be computed as the sum of the central $15 \times h$ rectangle, plus two triangles. Each triangle has height h and base $15 \cos \theta$. Hence

$$\begin{aligned} A &= 15h + 2 \cdot \frac{1}{2} \cdot h \cdot 15 \cos \theta \\ &= 15h(1 + \cos \theta) \end{aligned}$$

- Since $h = 15 \sin \theta$ we can rewrite the area as a function of just θ :

$$A(\theta) = 225 \sin \theta (1 + \cos \theta)$$

where $0 \leq \theta \leq \pi$.

- Now we use Corollary 8.2.3. The ends of the interval give

$$\begin{aligned} A(0) &= 225 \sin 0 (1 + \cos 0) = 0 \\ A(\pi) &= 225 \sin \pi (1 + \cos \pi) = 0 \end{aligned}$$

The derivative is

$$\begin{aligned} A'(\theta) &= 225 \cos \theta \cdot (1 + \cos \theta) + 225 \sin \theta \cdot (-\sin \theta) \\ &= 225 [\cos \theta + \cos^2 \theta - \sin^2 \theta] && \text{recall } \sin^2 \theta = 1 - \cos^2 \theta \\ &= 225 [\cos \theta + 2\cos^2 \theta - 1] \end{aligned}$$

⁶ Again, no pun intended.

This is a continuous function, so there are no singular points. However we can still hunt for critical points by solving $A'(\theta) = 0$. That is

$$\begin{aligned} 2\cos^2\theta + \cos\theta - 1 &= 0 && \text{factor carefully} \\ (2\cos\theta - 1)(\cos\theta + 1) &= 0 \end{aligned}$$

Hence we must have $\cos\theta = -1$ or $\cos\theta = \frac{1}{2}$. On the domain $0 \leq \theta \leq \pi$, this means $\theta = \pi/3$ or $\theta = \pi$.

$$\begin{aligned} A(\pi) &= 0 \\ A(\pi/3) &= 225 \sin(\pi/3)(1 + \cos(\pi/3)) \\ &= 225 \cdot \frac{\sqrt{3}}{2} \cdot \left(1 + \frac{1}{2}\right) \\ &= 225 \cdot \frac{3\sqrt{3}}{4} \approx 292.28 \end{aligned}$$

- Thus the cross-sectional area is maximised when $\theta = \frac{\pi}{3}$.

Example 8.3.6

Example 8.3.7

Find the points on the ellipse $\frac{x^2}{4} + y^2 = 1$ that are nearest to and farthest from the point $(1, 0)$.

Solution. While this is another distance problem, the possible values of x, y are bounded, so we need Corollary 8.2.3 rather than Theorem 8.3.3.

- We start by drawing a picture:

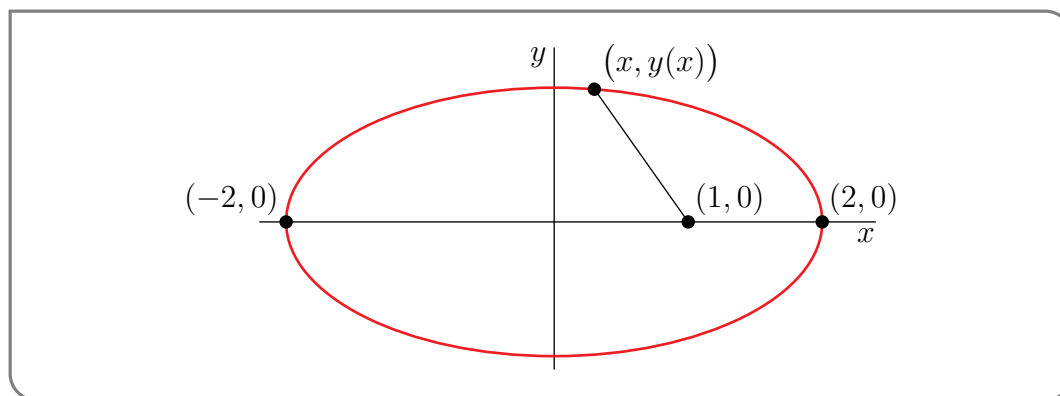

- Let ℓ be the distance from the point (x, y) on the ellipse to the point $(1, 0)$. As was the case above, we will maximise the squared-distance.

$$\ell^2 = (x - 1)^2 + y^2.$$

- Since (x, y) lie on the ellipse we have

$$\frac{x^2}{4} + y^2 = 1$$

Note that this also shows that $-2 \leq x \leq 2$ and $-1 \leq y \leq 1$.

Isolating y^2 and substituting this into our expression for ℓ^2 gives

$$\ell^2 = (x-1)^2 + \underbrace{1 - x^2/4}_{=y^2}.$$

- Now we can apply Corollary 8.2.3. The endpoints of the domain give

$$\ell^2(-2) = (-2-1)^2 + 1 - (-2)^2/4 = 3^2 + 1 - 1 = 9$$

$$\ell^2(2) = (2-1)^2 + 1 - 2^2/4 = 1 + 1 - 1 = 1$$

The derivative is

$$\frac{d}{dx}\ell^2 = 2(x-1) - x/2 = \frac{3x}{2} - 2$$

Thus there are no singular points, but there is a critical point at $x = 4/3$. The corresponding squared-distance is

$$\begin{aligned}\ell^2(4/3) &= \left(\frac{4}{3} - 1\right)^2 + 1 - \frac{(4/3)^2}{4} \\ &= (1/3)^2 + 1 - (4/9) = 6/9 = 2/3.\end{aligned}$$

- To summarise (and giving distances and coordinates of points):

x	(x, y)	ℓ
-2	$(-2, 0)$	3
4/3	$(4/3, \pm\sqrt{5}/3)$	$\sqrt{2/3}$
2	$(2, 0)$	1

The point of maximum distance is $(-2, 0)$, and the point of minimum distance is $(4/3, \pm\sqrt{5}/3)$.

Example 8.3.7

Example 8.3.8

Find the dimensions of the rectangle of largest area that can be inscribed in an equilateral triangle of side a if one side of the rectangle lies on the base of the triangle.

Solution. Since the rectangle must sit inside the triangle, its dimensions are bounded and we will end up using Corollary 8.2.3.

- Carefully draw a picture:

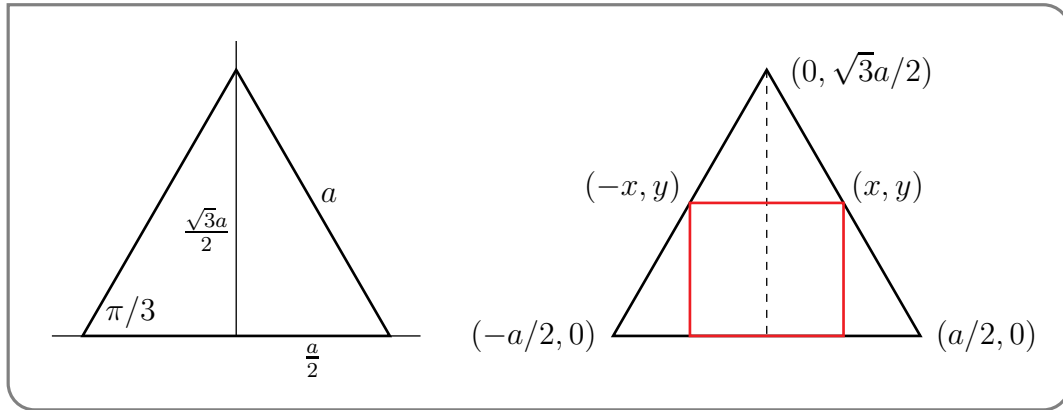

We have drawn (on the left) the triangle in the xy -plane with its base on the x -axis. The base has been drawn running from $(-a/2, 0)$ to $(a/2, 0)$ so its centre lies at the origin. A little Pythagoras (or a little trigonometry) tells us that the height of the triangle is

$$\sqrt{a^2 - (a/2)^2} = \frac{\sqrt{3}}{2} \cdot a = a \cdot \sin \frac{\pi}{3}$$

Thus the vertex at the top of the triangle lies at $(0, \frac{\sqrt{3}}{2} \cdot a)$.

- If we construct a rectangle that does not touch the sides of the triangle, then we can increase the dimensions of the rectangle until it touches the triangle and so make its area larger. Thus we can assume that the two top corners of the rectangle touch the triangle as drawn in the right-hand figure above.
- Now let the rectangle be $2x$ wide and y high. And let A denote its area. Clearly

$$A = 2xy.$$

where $0 \leq x \leq a/2$ and $0 \leq y \leq \frac{\sqrt{3}}{2}a$.

- Our construction means that the top-right corner of the rectangle will have coordinates (x, y) and lie on the line joining the top vertex of the triangle at $(0, \sqrt{3}a/2)$ to the bottom-right vertex at $(a/2, 0)$. In order to write the area as a function of x alone, we need the equation for this line since it will tell us how to write y as a function of x . The line has slope

$$\text{slope} = \frac{\sqrt{3}a/2 - 0}{0 - a/2} = -\sqrt{3}.$$

and passes through the point $(0, \sqrt{3}a/2)$, so any point (x, y) on that line satisfies:

$$y = -\sqrt{3}x + \frac{\sqrt{3}}{2}a.$$

- We can now write the area as a function of x alone

$$\begin{aligned} A(x) &= 2x \left(-\sqrt{3}x + \frac{\sqrt{3}}{2}a \right) \\ &= \sqrt{3}x(a - 2x). \end{aligned}$$

with $0 \leq x \leq a/2$.

- The ends of the domain give:

$$A(0) = 0$$

$$A(a/2) = 0.$$

The derivative is

$$A'(x) = \sqrt{3}(x \cdot (-2) + 1 \cdot (a - 2x)) = \sqrt{3}(a - 4x).$$

Since this is a polynomial there are no singular points, but there is a critical point at $x = a/4$. There

$$A(a/4) = \sqrt{3} \cdot \frac{a}{4} \cdot (a - a/2) = \sqrt{3} \cdot \frac{a^2}{8}.$$

$$y = -\sqrt{3} \cdot (a/4) + \frac{\sqrt{3}}{2}a = \sqrt{3} \cdot \frac{a}{4}.$$

- Checking the question again, we see that we are asked for the dimensions rather than the area, so the answer is $2x \times y$:

The largest such rectangle has dimensions $\frac{a}{2} \times \frac{\sqrt{3}a}{4}$.

Example 8.3.8

This next one is a good physics example. In it we will derive Snell's Law⁷ from Fermat's principle⁸.

Example 8.3.9

Consider the figure below which shows the trajectory of a ray of light as it passes through two different mediums (say air and water).

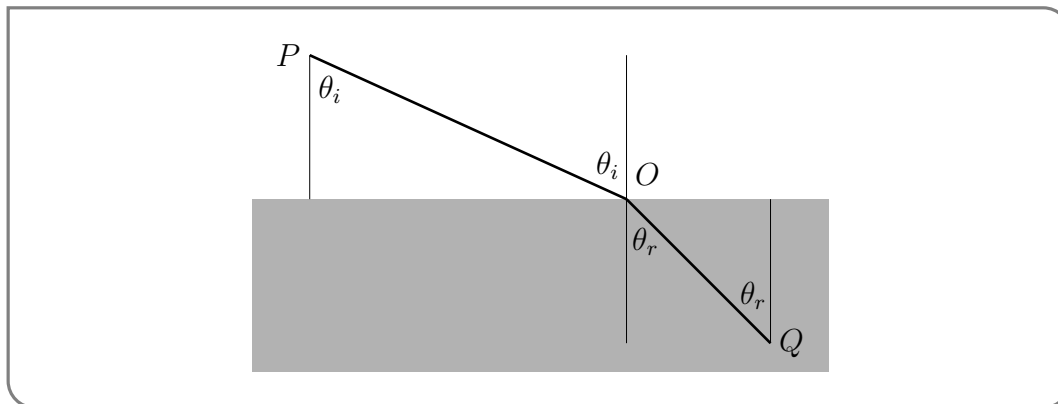

Let c_a be the speed of light in air and c_w be the speed of light in water. Fermat's principle states that a ray of light will always travel along a path that minimises the time taken. So if a ray of light

7 Snell's law is named after the Dutch astronomer Willebrord Snellius who derived it in around 1621, though it was first stated accurately in 984 by Ibn Sahl.

8 Named after Pierre de Fermat who described it in a letter in 1662. The beginnings of the idea, however, go back as far as Hero of Alexandria in around 60CE. Hero is credited with many inventions including the first vending machine, and a precursor of the steam engine called an aeolipile.

travels from P (in air) to Q (in water) then it will “choose” the point O (on the interface) so as to minimise the total time taken. Use this idea to show Snell’s law,

$$\frac{\sin \theta_i}{\sin \theta_r} = \frac{c_a}{c_w}$$

where θ_i is the angle of incidence and θ_r is the angle of refraction (as illustrated in the figure above).

Solution. This problem is a little more abstract than the others we have examined, but we can still apply Theorem 8.3.3.

- We are given a figure in the statement of the problem and it contains all the relevant points and angles. However it will simplify things if we decide on a coordinate system. Let’s assume that the point O lies on the x -axis, at coordinates $(x, 0)$. The point P then lies above the axis at $(X_P, +Y_P)$, while Q lies below the axis at $(X_Q, -Y_Q)$. This is drawn below.

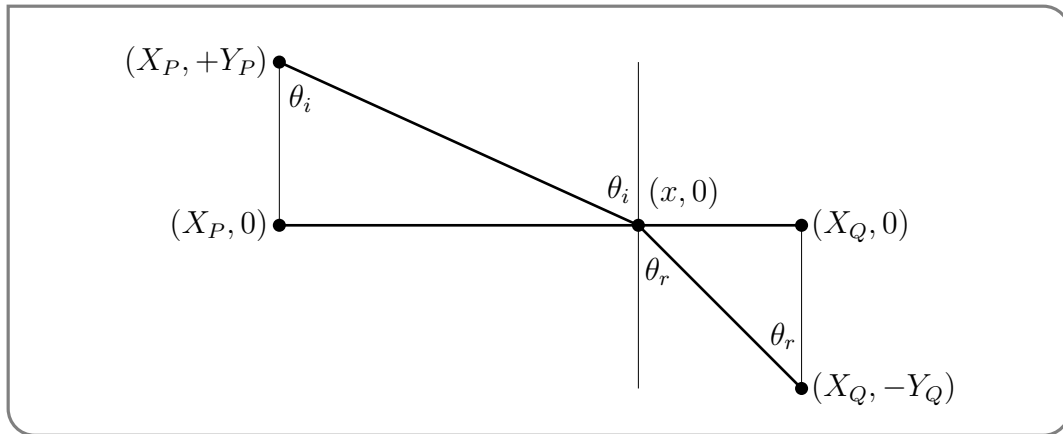

- The statement of Snell’s law contains terms $\sin \theta_i$ and $\sin \theta_r$, so it is a good idea for us to see how to express these in terms of the coordinates we have just introduced:

$$\sin \theta_i = \frac{\text{opposite}}{\text{hypotenuse}} = \frac{(x - X_P)}{\sqrt{(X_P - x)^2 + Y_P^2}}$$

$$\sin \theta_r = \frac{\text{opposite}}{\text{hypotenuse}} = \frac{(X_Q - x)}{\sqrt{(X_Q - x)^2 + Y_Q^2}}$$

- Let ℓ_P denote the distance PO , and ℓ_Q denote the distance OQ . Then we have

$$\ell_P = \sqrt{(X_P - x)^2 + Y_P^2}$$

$$\ell_Q = \sqrt{(X_Q - x)^2 + Y_Q^2}$$

If we then denote the total time taken by T , then

$$T = \frac{\ell_P}{c_a} + \frac{\ell_Q}{c_w} = \frac{1}{c_a} \sqrt{(X_P - x)^2 + Y_P^2} + \frac{1}{c_w} \sqrt{(X_Q - x)^2 + Y_Q^2}$$

which is written as a function of x since all the other terms are constants.

- Notice that as $x \rightarrow +\infty$ or $x \rightarrow -\infty$ the total time $T \rightarrow \infty$ and so we can apply Theorem 8.3.3. The derivative is

$$\frac{dT}{dx} = \frac{1}{c_a} \frac{-2(X_P - x)}{2\sqrt{(X_P - x)^2 + Y_P^2}} + \frac{1}{c_w} \frac{-2(X_Q - x)}{2\sqrt{(X_Q - x)^2 + Y_Q^2}}$$

Notice that the terms inside the square-roots cannot be zero or negative since they are both sums of squares and $Y_P, Y_Q > 0$. So there are no singular points, but there is a critical point when $T'(x) = 0$, namely when

$$\begin{aligned} 0 &= \frac{1}{c_a} \frac{X_P - x}{\sqrt{(X_P - x)^2 + Y_P^2}} + \frac{1}{c_w} \frac{X_Q - x}{\sqrt{(X_Q - x)^2 + Y_Q^2}} \\ &= \frac{-\sin \theta_i}{c_a} + \frac{\sin \theta_r}{c_w} \end{aligned}$$

Rearrange this to get

$$\begin{aligned} \frac{\sin \theta_i}{c_a} &= \frac{\sin \theta_r}{c_w} && \text{move sines to one side} \\ \frac{\sin \theta_i}{\sin \theta_r} &= \frac{c_a}{c_w} \end{aligned}$$

which is exactly Snell's law.

Example 8.3.9

Example 8.3.10

The Statue of Liberty has height 46m and stands on a 47m tall pedestal. How far from the statue should an observer stand to maximize the angle subtended by the statue at the observer's eye, which is 1.5m above the base of the pedestal?

Solution. Obviously if we stand too close then all the observer sees is the pedestal, while if they stand too far then everything is tiny. The best spot for taking a photograph is somewhere in between.

- Draw a careful picture⁹

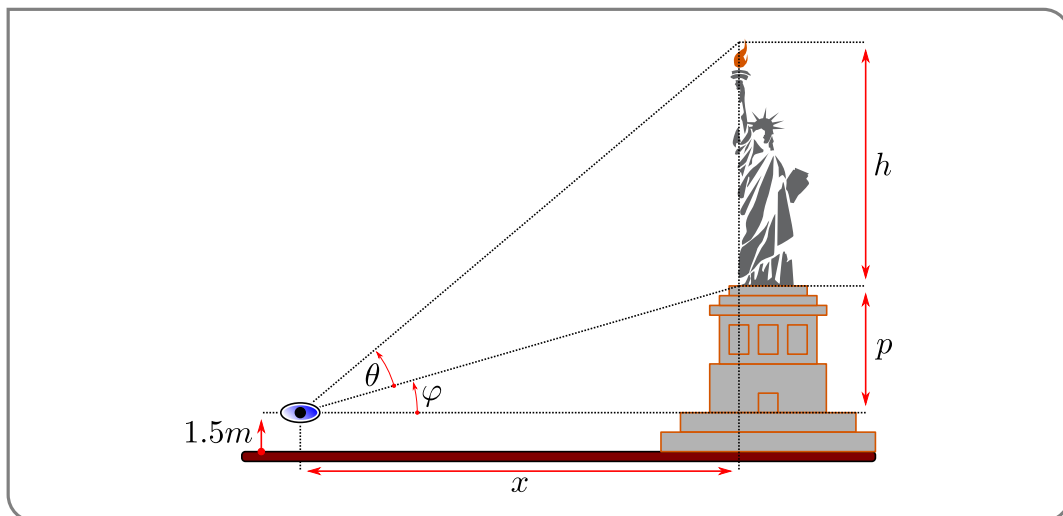

9 And make some healthy use of public domain clip art.

and we can put in the relevant lengths and angles.

- The height of the statue is $h = 46\text{m}$, and the height of the pedestal (above the eye) is $p = 47 - 1.5 = 45.5\text{m}$. The horizontal distance from the statue to the eye is x . There are two relevant angles. First θ is the angle subtended by the statue, while φ is the angle subtended by the portion of the pedestal above the eye.
- Some trigonometry gives us

$$\begin{aligned}\tan \varphi &= \frac{p}{x} \\ \tan(\varphi + \theta) &= \frac{p+h}{x}\end{aligned}$$

Thus

$$\begin{aligned}\varphi &= \arctan \frac{p}{x} \\ \varphi + \theta &= \arctan \frac{p+h}{x}\end{aligned}$$

and so

$$\theta = \arctan \frac{p+h}{x} - \arctan \frac{p}{x}.$$

- If we allow the viewer to stand at any point in front of the statue, then $0 \leq x < \infty$. Further observe that as $x \rightarrow \infty$ or $x \rightarrow 0$ the angle $\theta \rightarrow 0$, since

$$\lim_{x \rightarrow \infty} \arctan \frac{p+h}{x} = \lim_{x \rightarrow \infty} \arctan \frac{p}{x} = 0$$

and

$$\lim_{x \rightarrow 0^+} \arctan \frac{p+h}{x} = \lim_{x \rightarrow 0^+} \arctan \frac{p}{x} = \frac{\pi}{2}$$

Clearly the largest value of θ will be strictly positive and so has to be taken for some $0 < x < \infty$. (Note the strict inequalities.) This x will be a local maximum as well as a global maximum. As θ is not singular at any $0 < x < \infty$, we need only search for critical points. A careful application of the chain rule shows that the derivative is

$$\begin{aligned}\frac{d\theta}{dx} &= \frac{1}{1 + \left(\frac{p+h}{x}\right)^2} \cdot \left(\frac{-(p+h)}{x^2}\right) - \frac{1}{1 + \left(\frac{p}{x}\right)^2} \cdot \left(\frac{-p}{x^2}\right) \\ &= \frac{-(p+h)}{x^2 + (p+h)^2} + \frac{p}{x^2 + p^2}\end{aligned}$$

So a critical point occurs when

$$\begin{aligned}\frac{(p+h)}{x^2 + (p+h)^2} &= \frac{p}{x^2 + p^2} && \text{cross multiply} \\ (p+h)(x^2 + p^2) &= p(x^2 + (p+h)^2) && \text{collect } x \text{ terms} \\ x^2(p+h-p) &= p(p+h)^2 - p^2(p+h) && \text{clean up} \\ hx^2 &= p(p+h)(p+h-p) = ph(p+h) && \text{cancel common factors} \\ x^2 &= p(p+h) \\ x &= \pm \sqrt{p(p+h)} \approx \pm 64.9\text{m}\end{aligned}$$

- Thus the best place to stand approximately 64.9m in front or behind the statue. At that point $\theta \approx 0.348$ radians or 19.9° .

Example 8.3.10

Example 8.3.11

Find the length of the longest rod that can be carried horizontally (no tilting allowed) from a corridor 3m wide into a corridor 2m wide. The two corridors are perpendicular to each other.

Solution.

- Suppose that we are carrying the rod around the corner, then if the rod is as long as possible it must touch the corner and the outside walls of both corridors. A picture of this is show below.

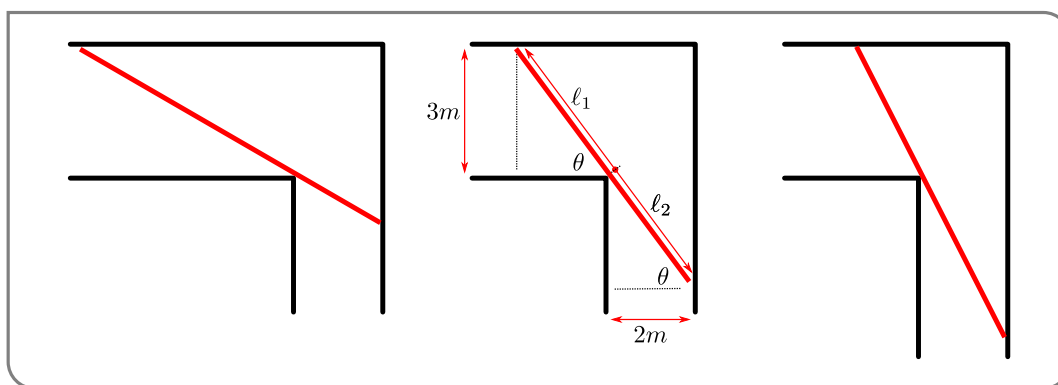

You can see that this gives rise to two similar triangles, one inside each corridor. Also the maximum length of the rod changes with the angle it makes with the walls of the corridor.

- Suppose that the angle between the rod and the inner wall of the 3m corridor is θ , as illustrated in the figure above. At the same time it will make an angle of $\frac{\pi}{2} - \theta$ with the outer wall of the 2m corridor. Denote by $\ell_1(\theta)$ the length of the part of the rod forming the hypotenuse of the upper triangle in the figure above. Similarly, denote by $\ell_2(\theta)$ the length of the part of the rod forming the hypotenuse of the lower triangle in the figure above. Then

$$\ell_1(\theta) = \frac{3}{\sin \theta} \quad \ell_2(\theta) = \frac{2}{\cos \theta}$$

and the total length is

$$\ell(\theta) = \ell_1(\theta) + \ell_2(\theta) = \frac{3}{\sin \theta} + \frac{2}{\cos \theta}$$

where $0 \leq \theta \leq \frac{\pi}{2}$.

- The length of the longest rod we can move through the corridor in this way is the minimum of $\ell(\theta)$. Notice that $\ell(\theta)$ is not defined at $\theta = 0, \frac{\pi}{2}$. Indeed we find that as $\theta \rightarrow 0^+$ or $\theta \rightarrow \frac{\pi}{2}^-$, the length $\ell \rightarrow +\infty$. (You should be able to picture what happens to our rod in those two limits). Clearly the minimum allowed $\ell(\theta)$ is going to be finite and will be achieved for some

$0 < \theta < \frac{\pi}{2}$ (note the strict inequalities) and so will be a local minimum as well as a global minimum. So we only need to find zeroes of $\ell'(\theta)$. Differentiating ℓ gives

$$\frac{d\ell}{d\theta} = -\frac{3 \cos \theta}{\sin^2 \theta} + \frac{2 \sin \theta}{\cos^2 \theta} = \frac{-3 \cos^3 \theta + 2 \sin^3 \theta}{\sin^2 \theta \cos^2 \theta}.$$

This does not exist at $\theta = 0, \frac{\pi}{2}$ (which we have already analysed) but does exist at every $0 < \theta < \frac{\pi}{2}$ and is equal to zero when the numerator is zero. Namely when

$$2 \sin^3 \theta = 3 \cos^3 \theta \quad \text{divide by } \cos^3 \theta$$

$$2 \tan^3 \theta = 3$$

$$\tan \theta = \sqrt[3]{\frac{3}{2}}$$

- From this we can recover $\sin \theta$ and $\cos \theta$, without having to compute θ itself. We can, for example, construct a right-angle triangle with adjacent length $\sqrt[3]{2}$ and opposite length $\sqrt[3]{3}$ (so that $\tan \theta = \sqrt[3]{3/2}$):

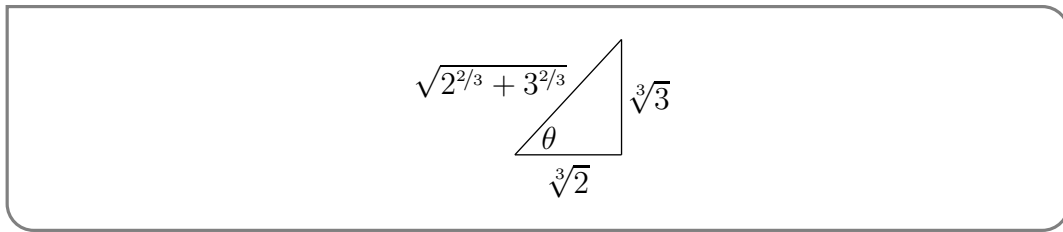

It has hypotenuse $\sqrt{3^{2/3} + 2^{2/3}}$, and so

$$\sin \theta = \frac{3^{1/3}}{\sqrt{3^{2/3} + 2^{2/3}}}$$

$$\cos \theta = \frac{2^{1/3}}{\sqrt{3^{2/3} + 2^{2/3}}}$$

Alternatively could use the identities:

$$1 + \tan^2 \theta = \sec^2 \theta$$

$$1 + \cot^2 \theta = \csc^2 \theta$$

to obtain expressions for $1/\cos \theta$ and $1/\sin \theta$.

- Using the above expressions for $\sin \theta, \cos \theta$ we find the minimum of ℓ (which is the longest rod that we can move):

$$\begin{aligned} \ell &= \frac{3}{\sin \theta} + \frac{2}{\cos \theta} = \frac{3}{\frac{\sqrt[3]{3}}{\sqrt{2^{2/3} + 3^{2/3}}}} + \frac{2}{\frac{\sqrt[3]{2}}{\sqrt{2^{2/3} + 3^{2/3}}}} \\ &= \sqrt{2^{2/3} + 3^{2/3}} [3^{2/3} + 2^{2/3}] \\ &= [2^{2/3} + 3^{2/3}]^{3/2} \approx 7.02\text{m} \end{aligned}$$

Example 8.3.11

A new challenge in this section is translating a word-problem into a mathematical problem. We start with elementary examples, and work to more complex situations with biological motivation.

8.4 ▲ Sample optimization problems

In the first examples, the function to optimize is specified, making the problem simply one of carefully applying calculus methods.

8.4.1 ►► Density dependent (logistic) growth in a population

Biologists often notice that the growth rate of a population depends not only on the size of the population, but also on how crowded it is. Constant growth is not sustainable. When individuals have to compete for resources, nesting sites, mates, or food, they cannot invest time nor energy in reproduction, leading to a decline in the rate of growth of the population. Such population growth is called **density dependent growth**.

One common example of density dependent growth is called the **logistic growth** law. Here it is assumed that the growth rate of the population, G depends on the density of the population, N , as follows:

$$G(N) = rN \left(\frac{K - N}{K} \right).$$

Concept Check-In

1. Give an example of units for N .
2. What units might G carry?

Here N is the **independent variable**, and $G(N)$ is the function of interest. All other quantities are constant:

- $r > 0$ is a constant, called the **intrinsic growth rate**, and
- $K > 0$ is a constant, called the **carrying capacity**. It represents the population density that a given environment can sustain.

Importantly, when differentiating G , we treat r and K as “numbers”. A generic sketch of G as a function of N is shown in Figure 8.1.

Example 8.4.1 (Logistic growth rate). Answer the following questions:

- a) Find the population density N that leads to the maximal growth rate $G(N)$.
- b) Find the value of the maximal growth in terms of r, K .
- c) For what population size is the growth rate zero?

Solution. We can expand $G(N)$:

$$G(N) = rN \left(\frac{K - N}{K} \right) = rN - \frac{r}{K}N^2,$$

from which it is apparent that $G(N)$ is a polynomial in powers of N , with constant coefficients r and r/K .

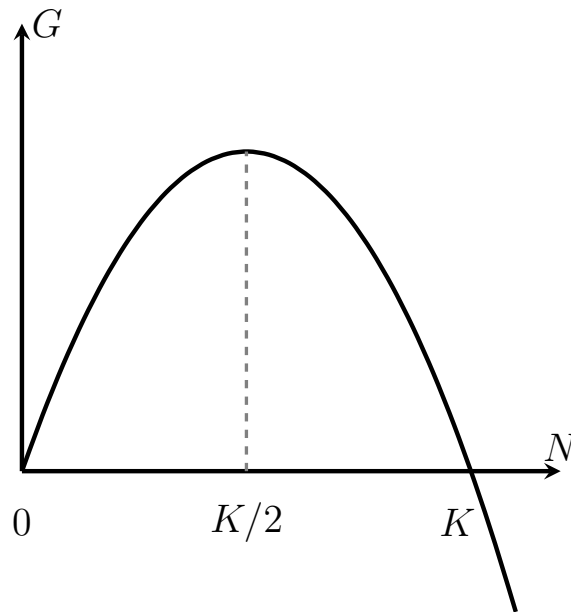

Figure 8.1: In logistic growth, the population growth rate G depends on population size N as shown here.

- a) To find critical points of $G(N)$, we find N such that $G'(N) = 0$, and then test for maxima:

$$G'(N) = r - 2\frac{r}{K}N = 0. \quad \Rightarrow \quad r = 2\frac{r}{K}N \quad \Rightarrow \quad N = \frac{K}{2}.$$

Hence, $N = K/2$ is a critical point, but is it a maximum? We check this in one of several ways. First, a sketch in Figure 8.1 reveals a downwards-opening parabola. This confirms a local maximum. Alternately, we can apply Theorem 8.1.4:

$$\begin{aligned} G''(N) = -2\frac{r}{K} < 0 & \Rightarrow G(N) \text{ concave down} \\ & \Rightarrow N = \frac{K}{2} \text{ is a local maximum} \end{aligned}$$

Thus, the population density with the greatest growth rate is $K/2$.

- b) The maximal growth rate is found by evaluating the function G at the critical point, $N = K/2$,

$$G\left(\frac{K}{2}\right) = r\left(\frac{K}{2}\right)\left(\frac{K - \frac{K}{2}}{K}\right) = r\frac{K}{2} \cdot \frac{1}{2} = \frac{rK}{4}.$$

- c) To find the population size at which the growth rate is zero, we set $G = 0$ and solve for N :

$$G(N) = rN\left(\frac{K - N}{K}\right) = 0.$$

There are two solutions. One is trivial: $N = 0$. (This is biologically interesting in the sense that it rules out the ancient idea of **spontaneous generation** - a defunct theory that held that

life can arise on its own, from dust or air. If $N = 0$, the growth rate is also 0, so no population spontaneously arises according to logistic growth.) The second solution, $N = K$ means that the population is at its “carrying capacity”.

◇

We return to this type of growth in Chapter 13.

8.4.2 ▶▶ Wine for Kepler’s wedding

In 1613, Kepler set out to purchase a few barrels of wine for his wedding party. To compute the cost, the merchant would plunge a measuring rod through the tap hole, as shown in Figure 8.2 and measure the length L of the “wet” part of rod. The cost would be set at a value proportional to L .

Kepler noticed that barrels come in different shapes. Some are tall and skinny, while others are squat and fat. He conjectured that some shapes would contain larger volumes for a given length L , i.e. would contain more wine for the same price. Knowing mathematics, he set out to determine which barrel shape would be the best bargain for his wedding.

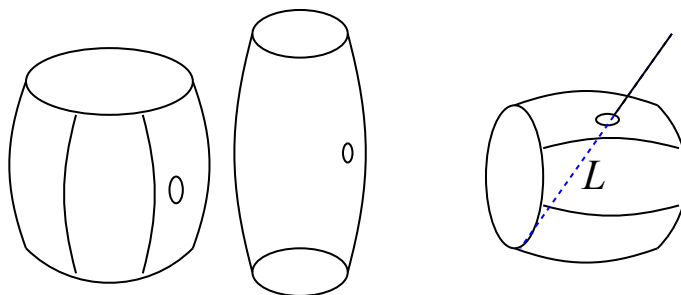

Figure 8.2: Barrels come in various shapes. But the cost of a barrel of wine was determined by the length L (dashed blue line segment) of the wet portion of the rod inserted into the tap hole. Kepler figured out which barrels contain the most wine for a given price.

Kepler sought the wine barrel that contains the most wine for a given cost. This is equivalent to asking *which cylinder has the largest volume for a fixed (constant) length L* . Below, we solve this optimization problem. An alternate approach is to seek the wine barrel that costs least for a given volume, which leads to the same result.

Example 8.4.2. Find the proportions (height:radius) of the cylinder with largest volume for a fixed length L (dashed line segment in Figure 8.2).

Solution. We make the following assumptions:

1. the barrel is a simple cylinder, as shown in Figure 8.3,
2. the tap-hole (normally sealed to avoid leaks) is half-way up the height of the barrel, and
3. the barrel is full to the top with wine.

Concept Check-In

3. Give two different examples of barrel dimensions which would both yield a volume of

160L.

Let r, h denote the radius and height of the barrel. These two variables uniquely determine the shape as well as the volume of the barrel. Note that because the barrel is assumed to be full, the volume of the cylinder is the same as the volume of wine, namely

$$V = \text{base area} \times \text{height}. \quad \Rightarrow \quad V = \pi r^2 h. \quad (8.4.1)$$

The rod used to “measure” the amount of wine (and hence determine the cost of the barrel) is shown as the diagonal of length L in Figure 8.3. Because the cylinder walls are perpendicular to its base, the length L is the hypotenuse of a right-angle triangle whose other sides have lengths $2r$ and $h/2$. (This follows from the assumption that the tap hole is half-way up the side.) Thus, by the Pythagorean theorem,

$$L^2 = (2r)^2 + \left(\frac{h}{2}\right)^2. \quad (8.4.2)$$

The problem can now be stated mathematically: maximize V in Eqn. (8.4.1) subject to a fixed value of L in Eqn. (8.4.2). The fact that L is fixed means that we have a **constraint**, as before, that we use to reduce the number of variables in the problem.

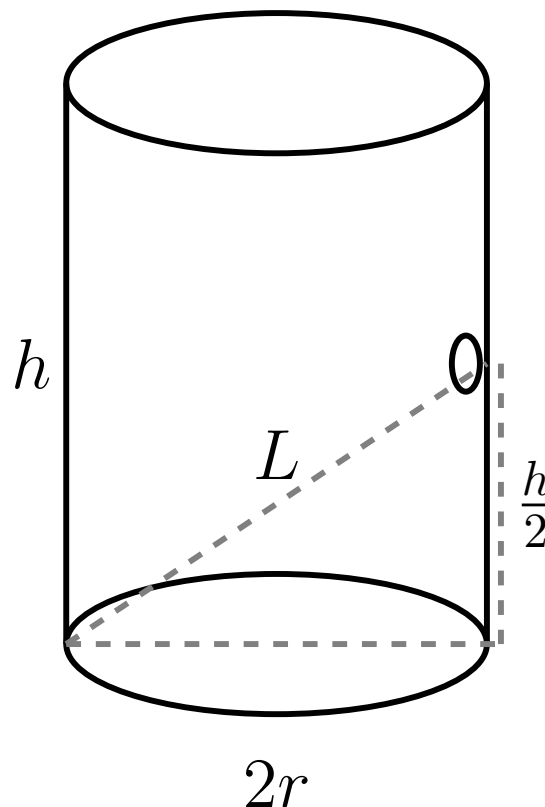

Figure 8.3: We simplify the problem to a cylindrical barrel with diameter $2r$ and height h . We assumed that the height of the tap-hole is $h/2$. Length L denotes the “wet” portion of the merchant’s rod, used to determine the cost. We observe a Pythagorean triangle formed by the dashed line segments.

Expanding the squares in the constraint and solving for r^2 leads to

$$L^2 = 4r^2 + \frac{h^2}{4} \quad \Rightarrow \quad r^2 = \frac{1}{4} \left(L^2 - \frac{h^2}{4} \right).$$

When we use this to eliminate r from the expression for V , we obtain

$$V = \pi r^2 h = \frac{\pi}{4} \left(L^2 - \frac{h^2}{4} \right) h = \frac{\pi}{4} \left(L^2 h - \frac{1}{4} h^3 \right).$$

The mathematical problem to solve is now: find h that maximizes

$$V(h) = \frac{\pi}{4} \left(L^2 h - \frac{1}{4} h^3 \right).$$

The function $V(h)$ is positive for h in the range $0 \leq h \leq 2L$, and $V = 0$ at the two endpoints of the interval. We can restrict attention to this interval since otherwise $V < 0$, which makes no physical sense. Since $V(h)$ is a smooth function, we anticipate that somewhere inside this range of values there should be a maximal volume.

Computing first and second derivatives, we find

$$V'(h) = \frac{\pi}{4} \left(L^2 - \frac{3}{4} h^2 \right), \quad V''(h) = \frac{\pi}{4} \left(0 - 2 \cdot \frac{3}{4} h \right) = -\frac{3}{8} \pi h < 0.$$

Setting $V'(h) = 0$ to find critical points, we then solve for h :

$$\begin{aligned} V'(h) = 0 & \quad \Rightarrow \quad L^2 - \frac{3}{4} h^2 = 0 \quad \Rightarrow \quad 3h^2 = 4L^2 \\ & \quad \Rightarrow \quad h^2 = 4 \frac{L^2}{3} \quad \Rightarrow \quad h = 2 \frac{L}{\sqrt{3}}. \end{aligned}$$

We verify that this solution is a local *maximum* by the following reasoning.

The second derivative $V''(h) = -\frac{3}{8} \pi h < 0$ is always negative for any positive value of h , so $V(h)$ is concave down for $h > 0$, which confirms a local maximum. We also noted that $V(r)$ is smooth, positive within the range of interest and zero at the endpoints. As there is only one critical point in that range, it must be a local maximum.

Finally, we find the radius of the barrel by plugging the optimal h into the constraint equation, i.e. using

$$\begin{aligned} r^2 &= \frac{1}{4} \left(L^2 - \frac{h^2}{4} \right) = \frac{1}{4} \left(L^2 - \frac{L^2}{3} \right) = \frac{1}{4} \left(\frac{2}{3} L^2 \right) \\ & \quad \Rightarrow \quad r = \frac{1}{\sqrt{3}\sqrt{2}} L. \end{aligned}$$

The shape of the optimal barrel can now be characterized. One way to do so is to specify the ratio of its height to its radius. (Tall skinny barrels have a large h/r ratio, and squat fat ones have a low ratio.) By the above reasoning, the ratio of h/r for the optimal barrel is

$$\frac{h}{r} = \frac{2 \frac{L}{\sqrt{3}}}{\frac{1}{\sqrt{3}\sqrt{2}} L} = 2\sqrt{2}. \quad (8.4.3)$$

Hence, for greatest economy, Kepler would have purchased barrels with height to radius ratio of $2\sqrt{2} = 2.82 \approx 3$. \diamond

Concept Check-In

4. If all barrels had a radius of 25cm, given the result Example 8.4.2, what would be the best barrel height?
5. What would the volume of such a barrel be?
6. Consider a barrel with radius 25cm and height 100cm. What is this barrel's volume?

8.4.3 ▶▶ Optimal foraging

Animals spend much of their time **foraging** - searching for food. Time is limited, since when the sun goes down, the risk of becoming food (to a predator) increases, and the likelihood of finding food decreases. Individuals who are most successful at finding food over that limited time have the greatest chance of surviving. It is argued by biologists that *evolution* tends to optimize animal behaviour by selecting those that are faster, stronger, or more fit, or - in this case - most efficient at finding food.

In this section, we investigate a model for optimal foraging. We follow the basic principles of (?) and (?).

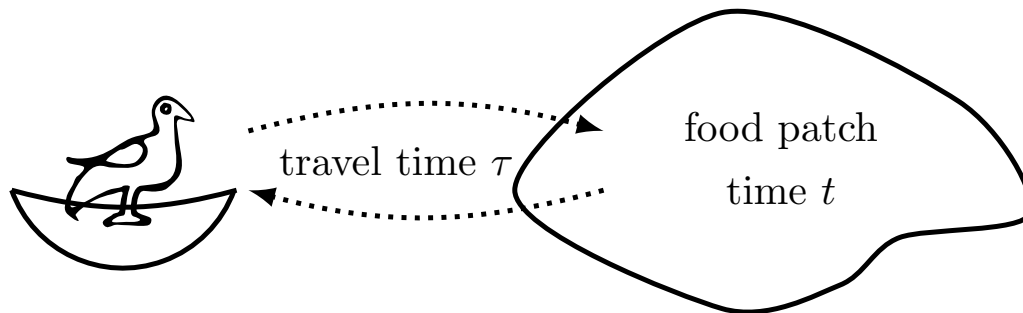

Figure 8.4: A bird travels daily to forage in a food patch. We want to determine how long it should stay in the patch to optimize its overall average energy gain per unit time.

Notation. We define the following notation:

- τ = travel time between nest and **food patch** (this is considered to be time that is unavoidably wasted).
- t = **residence time** in the patch (i.e. how long to spend foraging in one patch), also called **foraging time**,
- $f(t)$ = total energy gained by foraging in a patch for time t .

Energy gain in food patches.**Concept Check-In**

7. Which of the energy gain functions in Figure 8.5 are strictly increasing?

In some patches, food is ample and found quickly, while in others, it takes time and effort to obtain. The typical time needed to find food is reflected by various energy gain functions $f(t)$ shown in Figure 8.5.

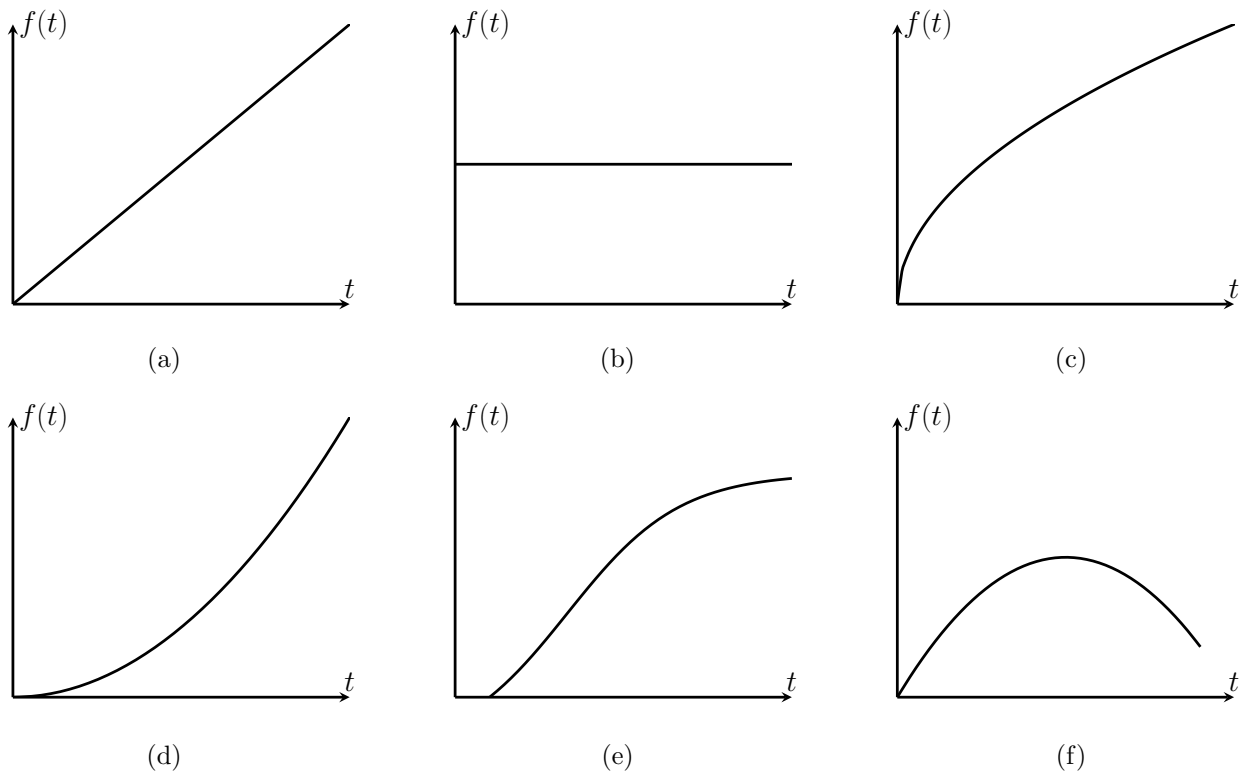

Figure 8.5: Examples of various total energy gain $f(t)$ for a given foraging time t . The shapes of these functions determine how hard or easy it is to extract food from a food patch.

Example 8.4.3 (Energy gain versus patch residence time). For each panel in Figure 8.5, explain what the graph of the total energy gain $f(t)$ is saying about the type of food patch: how easy or hard is it to find food?

Solution. The types of food patches are as follows:

1. The energy gain is linearly proportional to time spent in the patch. In this case, the patch has so much food that it is never depleted. It would make sense to stay in such a patch for as long as possible.
2. Energy gain is independent of time spent. The animal gets the full quantity as soon as it gets to the patch.
3. Food is gradually depleted, (the total energy gain levels off to some constant as t increases). There is “diminishing return” for staying longer, suggesting that it is best not to stay too long.
4. The reward for staying longer in this patch increases: the net energy gain is concave up ($f''(t) > 0$), so its slope is increasing.
5. It takes time to begin to gain energy. After some time, the gain increases, but eventually, the patch is depleted.

6. Staying too long in such a patch is disadvantageous, resulting in net loss of energy. It is important to leave this patch early enough to avoid that loss.

◇

Concept Check-In

8. Which model(s) can you automatically dismiss as not very biologically realistic?

Example 8.4.4. Consider the hypothetical patch energy function

$$f(t) = \frac{E_{max}t}{k+t} \quad \text{where } E_{max}, k > 0, \text{ are constants.} \quad (8.4.4)$$

- a) Match this function to one of the panels in Figure 8.5.
 b) Interpret the meanings of the constants E_{max}, k .

Solution.

- a) The function resembles Michaelis-Menten kinetics (Figure 1.7). In Figure 8.5, Panel (3) is the closest match.
 b) From Chapter 1, E_{max} is the horizontal asymptote, corresponding to an upper bound for the total amount of energy that can be extracted from the patch. The parameter k has units of time and controls the steepness of the function. Foraging for a time $t = k$, leads the animal to obtain half of the total available energy, since $f(k) = E_{max}/2$. ◇

Example 8.4.5 (Currency to optimize). We can assume that animals try to maximize the *average energy gain per unit time*, defined by the ratio:

$$R(t) = \frac{\text{Total energy gained}}{\text{total time spent}},$$

Write down $R(t)$ for the assumed patch energy function Eqn. 8.4.4.

Solution. The ‘total time spent’ is a sum of the fixed amount of time τ traveling, and time t foraging. The ‘total energy gained’ is $f(t)$. Thus, for the patch function $f(t)$ assumed in Eqn. (8.4.4),

Concept Check-In

9. What units might be used in the function $R(t)$?

$$R(t) = \frac{f(t)}{(\tau+t)} = \frac{E_{max}t}{(k+t)(\tau+t)}. \quad (8.4.5)$$

◇

We can now state the mathematical problem:

Find the time t that maximizes $R(t)$.

In finding such a t we are determining **the optimal residence time**.

Example 8.4.6. Use tools of calculus and curve-sketching to find and classify the critical points of $R(t)$ in Eqn. (8.4.5).

Solution. We first sketch $R(t)$, focusing on $t > 0$ for biological relevance.

- For $t \approx 0$, we have $R(t) \approx (E_{max}/k\tau)t$, which is a linearly increasing function.
- As $t \rightarrow \infty$, $R(t) \rightarrow E_{max}t/t^2 \rightarrow 0$, so the graph eventually decreases to zero.

These two conclusions are shown in Figure 8.6 (left panel), and strongly suggest that there should be a local maximum in the range $0 < t < \infty$, as shown in the right panel of Fig 8.6. Since the

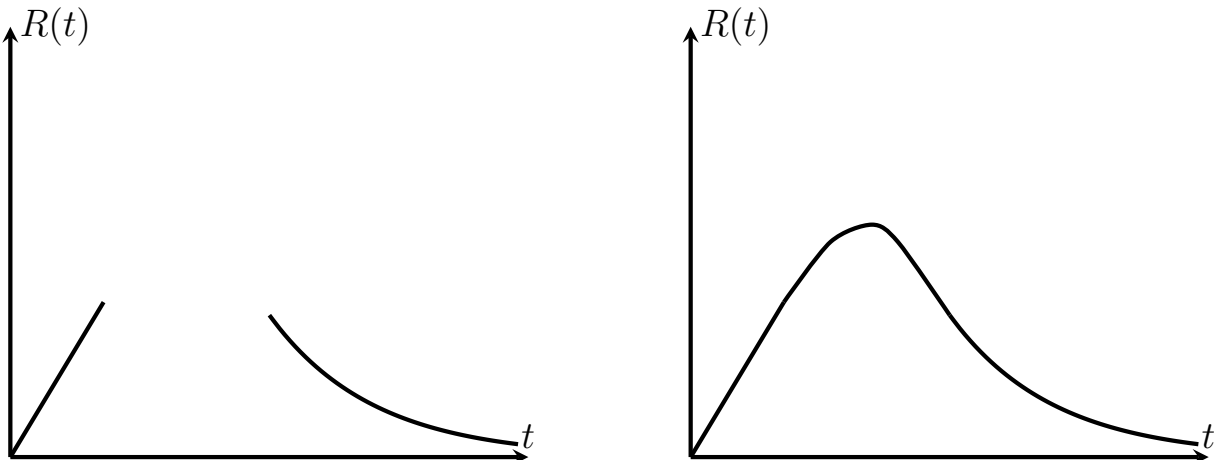

Figure 8.6: In Example 8.4.6 we first compose a rough sketch of the average rate of energy gain $R(t)$ in Eqn. (8.4.5). The graph is linear near the origin, and decays to zero at large t .

function is continuous for $t > 0$, this sketch verifies that there is a local maximum for some positive t value.

To find a local maximum, we compute $R'(t)$ using the quotient rule, and set $R'(t) = 0$:

$$R'(t) = E_{max} \frac{k\tau - t^2}{(k+t)^2(\tau+t)^2} = 0. \quad (8.4.6)$$

This can only be satisfied if the numerator is zero, that is

$$k\tau - t^2 = 0 \quad \Rightarrow \quad t_{1,2} = \pm\sqrt{k\tau}.$$

Rejecting the (irrelevant) negative root, we deduce that the critical point of the function $R(t)$ is $t_{crit} = \sqrt{k\tau}$. The sketch in Figure 8.6, verifies that this critical point is a local maximum. \diamond

Example 8.4.7. For practice, use one of the calculus tests for critical points to show that $t_{crit} = \sqrt{k\tau}$ is a local maximum for the function $R(t)$ in Eqn. (8.4.5).

Solution. $R(t)$ is a rational function, so a second derivative is messy. Instead, we apply the first derivative test—that is, we check the sign of $R'(t)$ on both sides of the critical point.

- Eqn. (8.4.6) gives $R'(t)$. Its denominator is positive, so the sign of $R'(t)$ is determined by its numerator, $(k\tau - t^2)$.

- Thus, $R'(t) > 0$ for $t < t_{crit}$, and $R'(t) < 0$ for $t > t_{crit}$.

This confirms that the function increases up to the critical point and decreases afterwards, so the critical point is a local maximum, henceforth denoted t_{max} . \diamond

To optimize the average rate of energy gain, $R(t)$, we found that the animal should stay in the patch for a duration of $t = t_{max} = \sqrt{k\tau}$.

Concept Check-In

10. Given t_{max} is the duration of time an animal should stay in a patch, and τ is travelling time, explain why the constant k is also in units of time.

Example 8.4.8. Determine the average rate of energy gain at this optimal patch residence time, i.e. find the maximal average rate of energy gain.

Solution. Computing $R(t)$ for $t = t_{max} = \sqrt{k\tau}$, we find that

$$R(t_{max}) = \frac{E_{max}t_{max}}{(k + t_{max})(\tau + t_{max})} = \frac{E_{max}}{\tau} \frac{1}{(1 + \sqrt{k/\tau})^2}. \quad (8.4.7)$$

8.5 ▲ Summary

1. Optimization is a process of finding critical points, and identifying local and global maxima/minima.
2. A scientific problem that address “biggest/smallest, best, most efficient” is often reducible to an optimization problem.
3. As with all mathematical models, translating scientific observations and reasonable assumptions into mathematical terms is an important first step.
4. The following applications were considered:
 - (a) Density dependent population growth. Using a given logistic growth law, the following parameters were considered:
 - population growth rate (to be maximized),
 - population density,
 - intrinsic growth rate (constant),
 - carrying capacity (constant).
 - (b) Wine for Kepler’s wedding, seeking the largest barrel volume for a fixed diagonal length. The following parameters were considered:
 - barrel volume, (to be maximized)
 - barrel height,
 - barrel radius,
 - length of the diagonal (constant).

(c) Foraging time for an animal collecting food. We considered:

- travel time between nest and food patch,
- foraging time in the patch,
- energy gained by foraging in a patch for various time durations.

Quick Concept Check

1. If the growth rate of a population follows the following logistic equation:

$$G(N) = 1.2N \left(\frac{50000 - N}{50000} \right),$$

where N is the density of the population, under what circumstances is the population growing fastest?

2. When finding a global maximum, why is always imperative to check the endpoints?
3. Demonstrate the variability of barrel dimensions by giving two different height and radius pairs which lead to a volume of 50L.
4. Would the answer to Kepler's wine barrel problem have changed if we had solved for h^2 instead of r^2 ?

APPROXIMATING FUNCTIONS NEAR A SPECIFIED POINT— TAYLOR POLYNOMIALS

Learning Objectives

- Use a linear approximation to approximate a differentiable function that is difficult to evaluate exactly. This includes choosing an appropriate centre point.
- Use a linear approximation to approximate an irrational number with a rational number. This may include choosing an appropriate centre point as well as an appropriate function.
- Explain what a degree n approximation of a function is.
- Determine degree n approximations for appropriately differentiable functions.
- State the Maclaurin polynomials for the standard functions: $\frac{1}{1-x}$, e^x , $\cos x$, $\sin x$, $\log(1+x)$.

Suppose that you are interested in the values of some function $f(x)$ for x near some fixed point a . When the function is a polynomial or a rational function we can use some arithmetic (and maybe some hard work) to write down the answer. For example:

$$\begin{aligned}
 f(x) &= \frac{x^2 - 3}{x^2 - 2x + 4} \\
 f(1/5) &= \frac{\frac{1}{25} - 3}{\frac{1}{25} - \frac{2}{5} + 4} = \frac{\frac{1-75}{25}}{\frac{1-10+100}{25}} \\
 &= \frac{-74}{91}
 \end{aligned}$$

Tedious, but we can do it. On the other hand if you are asked to compute $\sin(1/10)$ then what can

we do? We know that a calculator can work it out

$$\sin(1/10) = 0.09983341 \dots$$

but how does the calculator do this? How did people compute this before calculators¹? A hint comes from the following sketch of $\sin(x)$ for x around 0.

Figure 9.0.1.

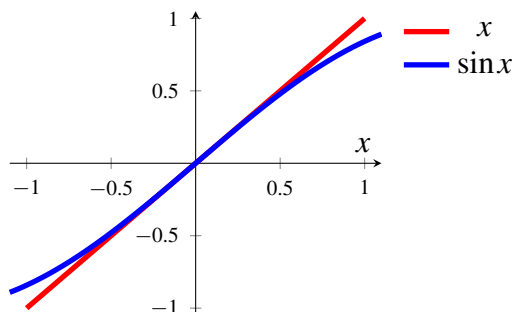

The above figure shows that the curves $y = x$ and $y = \sin x$ are almost the same when x is close to 0. Hence if we want the value of $\sin(1/10)$ we could just use this approximation $y = x$ to get

$$\sin(1/10) \approx 1/10.$$

Of course, in this case we simply observed that one function was a good approximation of the other. We need to know how to find such approximations more systematically.

More precisely, say we are given a function $f(x)$ that we wish to approximate close to some point $x = a$, and we need to find another function $F(x)$ that

- is simple and easy to compute²
- is a good approximation to $f(x)$ for x values close to a .

Further, we would like to understand how good our approximation actually is. Namely we need to be able to estimate the error $|f(x) - F(x)|$.

There are many different ways to approximate a function and we will discuss one family of approximations: Taylor polynomials. This is an infinite family of ever improving approximations, and our starting point is the very simplest.

9.1 ▲ Zeroth approximation — the constant approximation

The simplest functions are those that are constants. And our zeroth³ approximation will be by a constant function. That is, the approximating function will have the form $F(x) = A$, for some constant A . Notice that this function is a polynomial of degree zero.

- 1 Originally the word “calculator” referred not to the software or electronic (or even mechanical) device we think of today, but rather to a person who performed calculations.
- 2 It is no good approximating a function with something that is even more difficult to work with.
- 3 It barely counts as an approximation at all, but it will help build intuition. Because of this, and the fact that a constant is a polynomial of degree 0, we’ll start counting our approximations from zero rather than 1.

To ensure that $F(x)$ is a good approximation for x close to a , we choose A so that $f(x)$ and $F(x)$ take exactly the same value when $x = a$.

$$F(x) = A \quad \text{so} \quad F(a) = A = f(a) \implies A = f(a)$$

Our first, and crudest, approximation rule is

Equation 9.1.1 (Constant approximation).

$$f(x) \approx f(a)$$

An important point to note is that we need to know $f(a)$ — if we cannot compute that easily then we are not going to be able to proceed. We will often have to choose a (the point around which we are approximating $f(x)$) with some care to ensure that we can compute $f(a)$.

Here is a figure showing the graphs of a typical $f(x)$ and approximating function $F(x)$. At

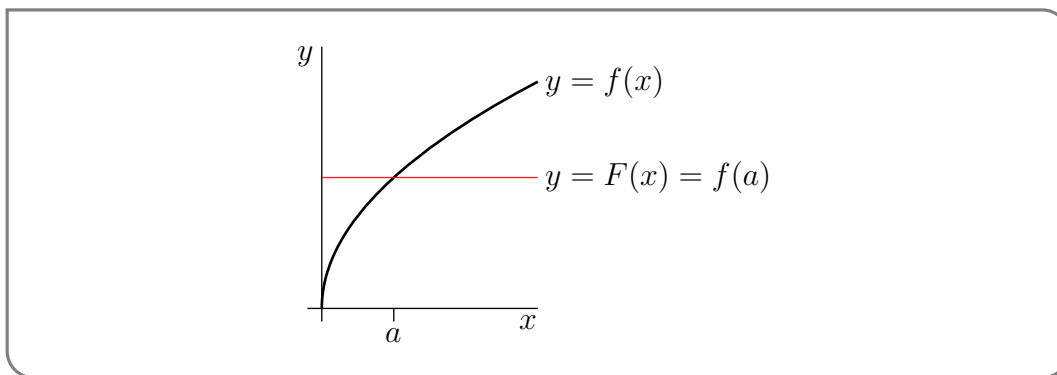

$x = a$, $f(x)$ and $F(x)$ take the same value. For x very near a , the values of $f(x)$ and $F(x)$ remain close together. But the quality of the approximation deteriorates fairly quickly as x moves away from a . Clearly we could do better with a straight line that follows the slope of the curve. That is our next approximation.

But before then, an example:

Example 9.1.2

Use the constant approximation to estimate $e^{0.1}$.

Solution. First set $f(x) = e^x$.

- Now we first need to pick a point $x = a$ to approximate the function. This point needs to be close to 0.1 and we need to be able to evaluate $f(a)$ easily. The obvious choice is $a = 0$.
- Then our constant approximation is just

$$F(x) = f(0) = e^0 = 1$$

$$F(0.1) = 1$$

Note that $e^{0.1} = 1.105170918\dots$, so even this approximation isn't too bad..

Example 9.1.2

9.2 ▲ First approximation — the linear approximation

Our first⁴ approximation improves on our zeroth approximation by allowing the approximating function to be a linear function of x rather than just a constant function. That is, we allow $F(x)$ to be of the form $A + Bx$, for some constants A and B .

To ensure that $F(x)$ is a good approximation for x close to a , we still require that $f(x)$ and $F(x)$ have the same value at $x = a$ (that was our zeroth approximation). Our additional requirement is that their tangent lines at $x = a$ have the same slope — that the derivatives of $f(x)$ and $F(x)$ are the same at $x = a$. Hence

$$\begin{aligned} F(x) &= A + Bx & \implies & & F(a) &= A + Ba = f(a) \\ F'(x) &= B & \implies & & F'(a) &= B = f'(a) \end{aligned}$$

So we must have $B = f'(a)$. Substituting this into $A + Ba = f(a)$ we get $A = f(a) - af'(a)$. So we can write

$$\begin{aligned} F(x) &= A + Bx = \overbrace{f(a) - af'(a)}^A + f'(a) \cdot x \\ &= f(a) + f'(a) \cdot (x - a) \end{aligned}$$

We write it in this form because we can now clearly see that our first approximation is just an extension of our zeroth approximation. This first approximation is also often called the linear approximation of $f(x)$ about $x = a$.

Equation 9.2.1 (Linear approximation).

$$f(x) \approx f(a) + f'(a)(x - a)$$

We should again stress that in order to form this approximation we need to know $f(a)$ and $f'(a)$ — if we cannot compute them easily then we are not going to be able to proceed.

Recall, from Theorem 3.3.7, that $y = f(a) + f'(a)(x - a)$ is exactly the equation of the tangent line to the curve $y = f(x)$ at a . Here is a figure showing the graphs of a typical $f(x)$ and the approximating function $F(x)$. Observe that the graph of $f(a) + f'(a)(x - a)$ remains close to the

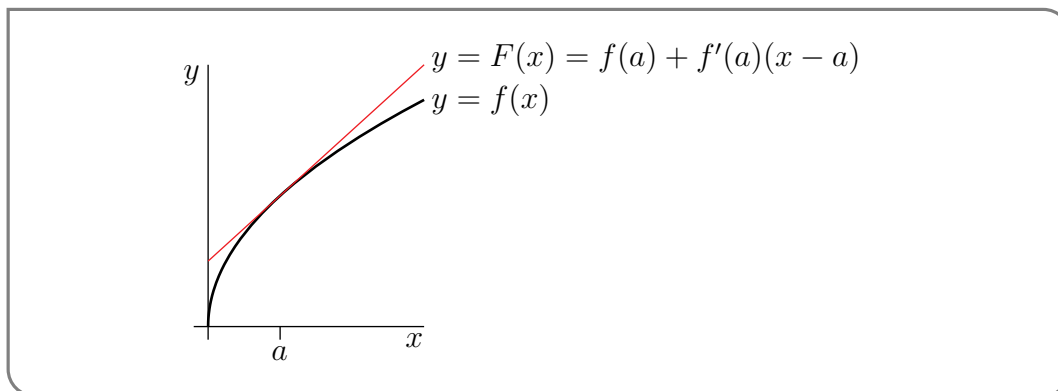

4 Recall that we started counting from zero.

graph of $f(x)$ for a much larger range of x than did the graph of our constant approximation, $f(a)$. One can also see that we can improve this approximation if we can use a function that curves down rather than being perfectly straight. That is our next approximation.

But before then, back to our example:

Example 9.2.2

Use the linear approximation to estimate $e^{0.1}$.

Solution. First set $f(x) = e^x$ and $a = 0$ as before.

- To form the linear approximation we need $f(a)$ and $f'(a)$:

$$\begin{array}{ll} f(x) = e^x & f(0) = 1 \\ f'(x) = e^x & f'(0) = 1 \end{array}$$

- Then our linear approximation is

$$\begin{aligned} F(x) &= f(0) + x f'(0) = 1 + x \\ F(0.1) &= 1.1 \end{aligned}$$

Recall that $e^{0.1} = 1.105170918\dots$, so the linear approximation is almost correct to 3 digits.

Example 9.2.2

It is worth doing another simple example here.

Example 9.2.3

Use a linear approximation to estimate $\sqrt{4.1}$.

Solution. First set $f(x) = \sqrt{x}$. Hence $f'(x) = \frac{1}{2\sqrt{x}}$. Then we are trying to approximate $f(4.1)$. Now we need to choose a sensible a value.

- We need to choose a so that $f(a)$ and $f'(a)$ are easy to compute.
 - We could try $a = 4.1$ — but then we need to compute $f(4.1)$ and $f'(4.1)$ — which is our original problem and more!
 - We could try $a = 0$ — then $f(0) = 0$ and $f'(0) = DNE$.
 - Setting $a = 1$ gives us $f(1) = 1$ and $f'(1) = \frac{1}{2}$. This would work, but we can get a better approximation by choosing a is closer to 4.1.
 - Indeed we can set a to be the square of any rational number and we'll get a result that is easy to compute.
 - Setting $a = 4$ gives $f(4) = 2$ and $f'(4) = \frac{1}{4}$. This seems good enough.

- Substitute this into equation (9.2.1) to get

$$\begin{aligned} f(4.1) &\approx f(4) + f'(4) \cdot (4.1 - 4) \\ &= 2 + \frac{0.1}{4} = 2 + 0.025 = 2.025 \end{aligned}$$

Notice that the true value is $\sqrt{4.1} = 2.024845673\dots$

Example 9.2.3

9.3 ▲ Second approximation — the quadratic approximation

We next develop a still better approximation by now allowing the approximating function be to a quadratic function of x . That is, we allow $F(x)$ to be of the form $A + Bx + Cx^2$, for some constants A , B and C . To ensure that $F(x)$ is a good approximation for x close to a , we choose A , B and C so that

- $f(a) = F(a)$ (just as in our zeroth approximation),
- $f'(a) = F'(a)$ (just as in our first approximation), and
- $f''(a) = F''(a)$ — this is a new condition.

These conditions give us the following equations

$$\begin{array}{lll} F(x) = A + Bx + Cx^2 & \implies & F(a) = A + Ba + Ca^2 = f(a) \\ F'(x) = B + 2Cx & \implies & F'(a) = B + 2Ca = f'(a) \\ F''(x) = 2C & \implies & F''(a) = 2C = f''(a) \end{array}$$

Solve these for C first, then B and finally A .

$$\begin{array}{ll} C = \frac{1}{2}f''(a) & \text{substitute} \\ B = f'(a) - 2Ca = f'(a) - af''(a) & \text{substitute again} \\ A = f(a) - Ba - Ca^2 = f(a) - a[f'(a) - af''(a)] - \frac{1}{2}f''(a)a^2 & \end{array}$$

Then put things back together to build up $F(x)$:

$$\begin{aligned} F(x) &= f(a) - f'(a)a + \frac{1}{2}f''(a)a^2 && \text{(this line is } A) \\ &\quad + f'(a)x - f''(a)ax && \text{(this line is } Bx) \\ &\quad \quad + \frac{1}{2}f''(a)x^2 && \text{(this line is } Cx^2) \\ &= f(a) + f'(a)(x-a) + \frac{1}{2}f''(a)(x-a)^2 \end{aligned}$$

Oof! We again write it in this form because we can now clearly see that our second approximation is just an extension of our first approximation.

Our second approximation is called the quadratic approximation:

Equation 9.3.1 (Quadratic approximation).

$$f(x) \approx f(a) + f'(a)(x-a) + \frac{1}{2}f''(a)(x-a)^2$$

Here is a figure showing the graphs of a typical $f(x)$ and approximating function $F(x)$. This new

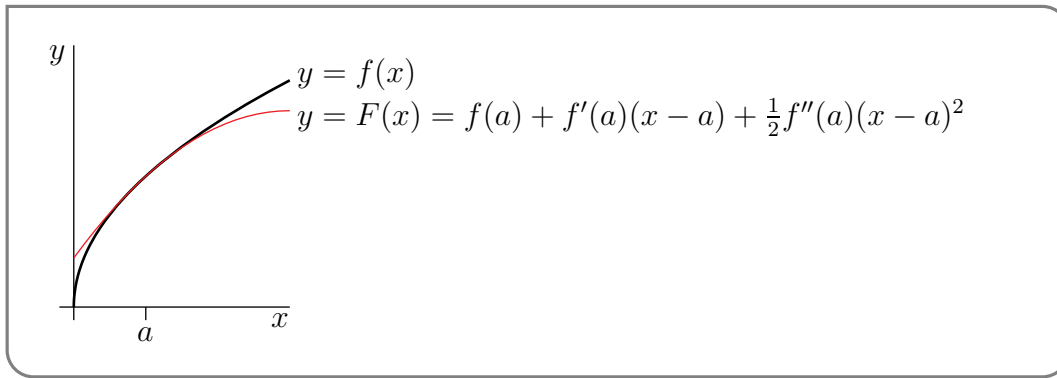

approximation looks better than both the first and second.

Now there is actually an easier way to derive this approximation, which we show you now. Let us rewrite⁵ $F(x)$ so that it is easy to evaluate it and its derivatives at $x = a$:

$$F(x) = \alpha + \beta \cdot (x - a) + \gamma \cdot (x - a)^2$$

Then

$$\begin{aligned} F(x) &= \alpha + \beta \cdot (x - a) + \gamma \cdot (x - a)^2 & F(a) &= \alpha = f(a) \\ F'(x) &= \beta + 2\gamma \cdot (x - a) & F'(a) &= \beta = f'(a) \\ F''(x) &= 2\gamma & F''(a) &= 2\gamma = f''(a) \end{aligned}$$

And from these we can clearly read off the values of α, β and γ and so recover our function $F(x)$. Additionally if we write things this way, then it is quite clear how to extend this to a cubic approximation and a quartic approximation and so on.

Return to our example:

Example 9.3.2

Use the quadratic approximation to estimate $e^{0.1}$.

Solution. Set $f(x) = e^x$ and $a = 0$ as before.

- To form the quadratic approximation we need $f(a), f'(a)$ and $f''(a)$:

$$\begin{aligned} f(x) &= e^x & f(0) &= 1 \\ f'(x) &= e^x & f'(0) &= 1 \\ f''(x) &= e^x & f''(0) &= 1 \end{aligned}$$

- Then our quadratic approximation is

$$\begin{aligned} F(x) &= f(0) + x f'(0) + \frac{1}{2} x^2 f''(0) = 1 + x + \frac{x^2}{2} \\ F(0.1) &= 1.105 \end{aligned}$$

⁵ Any polynomial of degree two can be written in this form. For example, when $a = 1$, $3 + 2x + x^2 = 6 + 4(x - 1) + (x - 1)^2$.

Recall that $e^{0.1} = 1.105170918\dots$, so the quadratic approximation is quite accurate with very little effort.

Example 9.3.2

Before we go on, let us first introduce (or revise) some notation that will make our discussion easier.

▲ Whirlwind tour of summation notation

In the remainder of this section we will frequently need to write sums involving a large number of terms. Writing out the summands explicitly can become quite impractical — for example, say we need the sum of the first 11 squares:

$$1 + 2^2 + 3^2 + 4^2 + 5^2 + 6^2 + 7^2 + 8^2 + 9^2 + 10^2 + 11^2$$

This becomes tedious. Where the pattern is clear, we will often skip the middle few terms and instead write

$$1 + 2^2 + \dots + 11^2.$$

A far more precise way to write this is using Σ (capital-sigma) notation. For example, we can write the above sum as

$$\sum_{k=1}^{11} k^2$$

This is read as

The sum from k equals 1 to 11 of k^2 .

More generally

Notation 9.3.3.

Let $m \leq n$ be integers and let $f(x)$ be a function defined on the integers. Then we write

$$\sum_{k=m}^n f(k)$$

to mean the sum of $f(k)$ for k from m to n :

$$f(m) + f(m+1) + f(m+2) + \cdots + f(n-1) + f(n).$$

Similarly we write

$$\sum_{i=m}^n a_i$$

to mean

$$a_m + a_{m+1} + a_{m+2} + \cdots + a_{n-1} + a_n$$

for some set of coefficients $\{a_m, \dots, a_n\}$.

Consider the example

$$\sum_{k=3}^7 \frac{1}{k^2} = \frac{1}{3^2} + \frac{1}{4^2} + \frac{1}{5^2} + \frac{1}{6^2} + \frac{1}{7^2}$$

It is important to note that the right hand side of this expression evaluates to a number⁶; it does not contain “ k ”. The summation index k is just a “dummy” variable and it does not have to be called k . For example

$$\sum_{k=3}^7 \frac{1}{k^2} = \sum_{i=3}^7 \frac{1}{i^2} = \sum_{j=3}^7 \frac{1}{j^2} = \sum_{\ell=3}^7 \frac{1}{\ell^2}$$

Also the summation index has no meaning outside the sum. For example

$$k \sum_{k=3}^7 \frac{1}{k^2}$$

has no mathematical meaning; It is gibberish⁷.

6 Some careful addition shows it is $\frac{46181}{176400}$.

7 Or possibly gobbledygook. For a discussion of statements without meaning and why one should avoid them we recommend the book “Bendable learnings: the wisdom of modern management” by Don Watson.

9.4 ▲ Still better approximations — Taylor polynomials

We can use the same strategy to generate still better approximations by polynomials⁸ of any degree we like. As was the case with the approximations above, we determine the coefficients of the polynomial by requiring, that at the point $x = a$, the approximation and its first n derivatives agree with those of the original function.

Rather than simply moving to a cubic polynomial, let us try to write things in a more general way. We will consider approximating the function $f(x)$ using a polynomial, $T_n(x)$, of degree n — where n is a non-negative integer. As we discussed above, the algebra is easier if we write

$$\begin{aligned} T_n(x) &= c_0 + c_1(x-a) + c_2(x-a)^2 + \cdots + c_n(x-a)^n \\ &= \sum_{k=0}^n c_k(x-a)^k \qquad \text{using } \Sigma \text{ notation} \end{aligned}$$

The above form^{9 10} makes it very easy to evaluate this polynomial and its derivatives at $x = a$. Before we proceed, we remind the reader of some notation (see Notation 3.3.13):

- Let $f(x)$ be a function and k be a positive integer. We can denote its k^{th} derivative with respect to x by

$$\frac{d^k f}{dx^k} \qquad \left(\frac{d}{dx}\right)^k f(x) \qquad f^{(k)}(x)$$

Additionally we will need

Definition 9.4.1 (Factorial).

Let n be a positive integer¹¹, then n -factorial, denoted $n!$, is the product

$$n! = n \times (n-1) \times \cdots \times 3 \times 2 \times 1$$

Further, we use the convention that

$$0! = 1$$

The first few factorials are

$$\begin{array}{lll} 1! = 1 & 2! = 2 & 3! = 6 \\ 4! = 24 & 5! = 120 & 6! = 720 \end{array}$$

8 Polynomials are generally a good choice for an approximating function since they are so easy to work with. Depending on the situation other families of functions may be more appropriate. For example if you are approximating a periodic function, then sums of sines and cosines might be a better choice; this leads to Fourier series.

9 Any polynomial in x of degree n can also be expressed as a polynomial in $(x-a)$ of the same degree n and vice versa. So $T_n(x)$ really still is a polynomial of degree n .

10 Furthermore when x is close to a , $(x-a)^k$ decreases very quickly as k increases, which often makes the "high k " terms in $T_n(x)$ very small. This can be a considerable advantage when building up approximations by adding more and more terms. If we were to rewrite $T_n(x)$ in the form $\sum_{k=0}^n b_k x^k$ the "high k " terms would typically not be very small when x is close to a .

Now consider $T_n(x)$ and its derivatives:

$$\begin{aligned}
 T_n(x) &= c_0 + c_1(x-a) + c_2(x-a)^2 + c_3(x-a)^3 + \cdots + c_n(x-a)^n \\
 T'_n(x) &= c_1 + 2c_2(x-a) + 3c_3(x-a)^2 + \cdots + nc_n(x-a)^{n-1} \\
 T''_n(x) &= 2c_2 + 6c_3(x-a) + \cdots + n(n-1)c_n(x-a)^{n-2} \\
 T'''_n(x) &= 6c_3 + \cdots + n(n-1)(n-2)c_n(x-a)^{n-3} \\
 &\vdots \\
 T_n^{(n)}(x) &= n! \cdot c_n
 \end{aligned}$$

Now notice that when we substitute $x = a$ into the above expressions only the constant terms survive and we get

$$\begin{aligned}
 T_n(a) &= c_0 \\
 T'_n(a) &= c_1 \\
 T''_n(a) &= 2 \cdot c_2 \\
 T'''_n(a) &= 6 \cdot c_3 \\
 &\vdots \\
 T_n^{(n)}(a) &= n! \cdot c_n
 \end{aligned}$$

So now if we want to set the coefficients of $T_n(x)$ so that it agrees with $f(x)$ at $x = a$ then we need

$$T_n(a) = c_0 = f(a) \qquad c_0 = f(a) = \frac{1}{0!}f(a)$$

We also want the first n derivatives of $T_n(x)$ to agree with the derivatives of $f(x)$ at $x = a$, so

$$\begin{aligned}
 T'_n(a) = c_1 = f'(a) & \qquad c_1 = f'(a) = \frac{1}{1!}f'(a) \\
 T''_n(a) = 2 \cdot c_2 = f''(a) & \qquad c_2 = \frac{1}{2}f''(a) = \frac{1}{2!}f''(a) \\
 T'''_n(a) = 6 \cdot c_3 = f'''(a) & \qquad c_3 = \frac{1}{6}f'''(a) = \frac{1}{3!}f'''(a)
 \end{aligned}$$

More generally, making the k^{th} derivatives agree at $x = a$ requires :

$$T_n^{(k)}(a) = k! \cdot c_k = f^{(k)}(a) \qquad c_k = \frac{1}{k!}f^{(k)}(a)$$

And finally the n^{th} derivative:

$$T_n^{(n)}(a) = n! \cdot c_n = f^{(n)}(a) \qquad c_n = \frac{1}{n!}f^{(n)}(a)$$

Putting this all together we have

11 It is actually possible to define the factorial of positive real numbers and even negative numbers but it requires more advanced calculus and is outside the scope of this course. The interested reader should look up the Gamma function.

Equation 9.4.2 (Taylor polynomial).

$$\begin{aligned}
 f(x) \approx T_n(x) &= f(a) + f'(a)(x-a) + \frac{1}{2}f''(a) \cdot (x-a)^2 + \cdots + \frac{1}{n!}f^{(n)}(a) \cdot (x-a)^n \\
 &= \sum_{k=0}^n \frac{1}{k!}f^{(k)}(a) \cdot (x-a)^k
 \end{aligned}$$

Let us formalise this definition.

Definition 9.4.3 (Taylor polynomial).

Let a be a constant and let n be a non-negative integer. The n^{th} degree Taylor polynomial for $f(x)$ about $x = a$ is

$$T_n(x) = \sum_{k=0}^n \frac{1}{k!}f^{(k)}(a) \cdot (x-a)^k.$$

The special case $a = 0$ is called a Maclaurin¹² polynomial.

Before we proceed with some examples, a couple of remarks are in order.

- While we can compute a Taylor polynomial about any a -value (providing the derivatives exist), in order to be a *useful* approximation, we must be able to compute $f(a), f'(a), \dots, f^{(n)}(a)$ easily. This means we must choose the point a with care. Indeed for many functions the choice $a = 0$ is very natural — hence the prominence of Maclaurin polynomials.
- If we have computed the approximation $T_n(x)$, then we can readily extend this to the next Taylor polynomial $T_{n+1}(x)$ since

$$T_{n+1}(x) = T_n(x) + \frac{1}{(n+1)!}f^{(n+1)}(a) \cdot (x-a)^{n+1}$$

This is very useful if we discover that $T_n(x)$ is an insufficient approximation, because then we can produce $T_{n+1}(x)$ without having to start again from scratch.

9.5 ▲ Some examples

Let us return to our running example of e^x :

12 The polynomials are named after Brook Taylor who devised a general method for constructing them in 1715. Slightly later, Colin Maclaurin made extensive use of the special case $a = 0$ (with attribution of the general case to Taylor) and it is now named after him. The special case of $a = 0$ was worked on previously by James Gregory and Isaac Newton, and some specific cases were known to the 14th century Indian mathematician Madhava of Sangamagrama.

Example 9.5.1

The constant, linear and quadratic approximations we used above were the first few Maclaurin polynomial approximations of e^x . That is

$$T_0(x) = 1 \qquad T_1(x) = 1 + x \qquad T_2(x) = 1 + x + \frac{x^2}{2}$$

Since $\frac{d}{dx}e^x = e^x$, the Maclaurin polynomials are very easy to compute. Indeed this invariance under differentiation means that

$$\begin{aligned} f^{(n)}(x) &= e^x & n = 0, 1, 2, \dots & \qquad \text{so} \\ f^{(n)}(0) &= 1 \end{aligned}$$

Substituting this into equation (9.4.2) we get

$$T_n(x) = \sum_{k=0}^n \frac{1}{k!} x^k$$

Thus we can write down the seventh Maclaurin polynomial very easily:

$$T_7(x) = 1 + x + \frac{x^2}{2} + \frac{x^3}{6} + \frac{x^4}{24} + \frac{x^5}{120} + \frac{x^6}{720} + \frac{x^7}{5040}$$

The following figure contains sketches of the graphs of e^x and its Taylor polynomials $T_n(x)$ for $n = 0, 1, 2, 3, 4$.

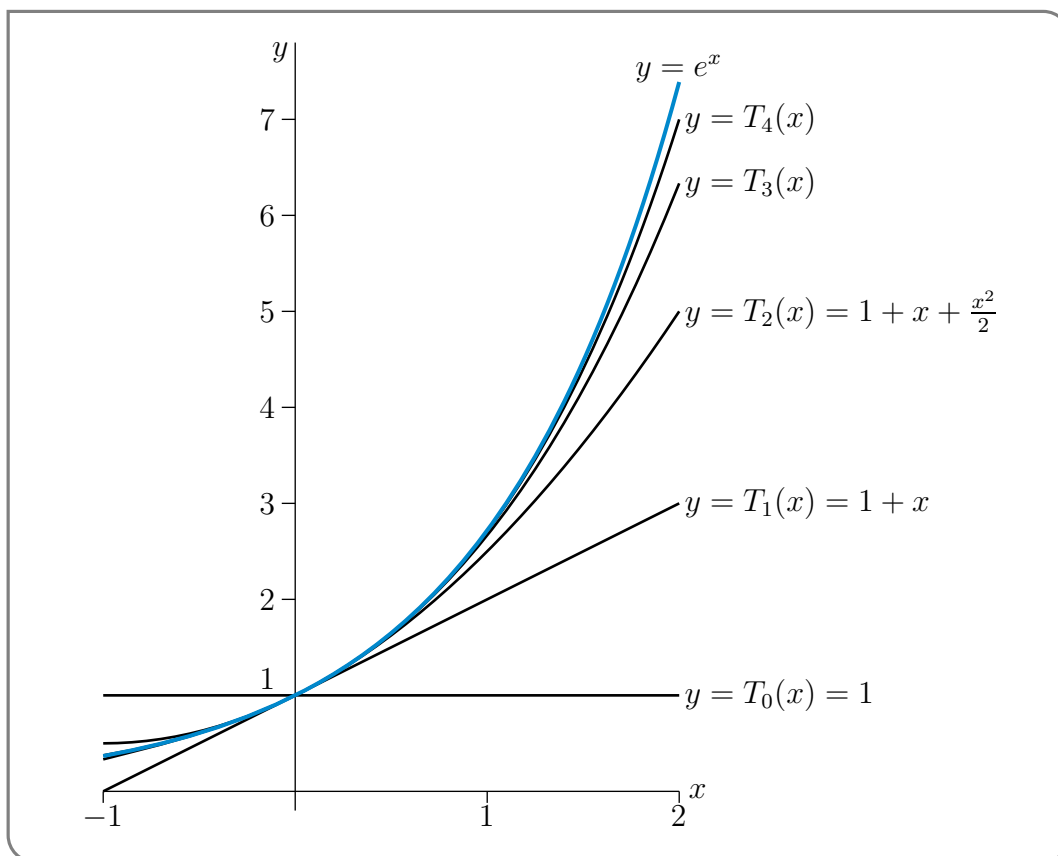

Also notice that if we use $T_7(1)$ to approximate the value of e^1 we obtain:

$$\begin{aligned} e^1 \approx T_7(1) &= 1 + 1 + \frac{1}{2} + \frac{1}{6} + \frac{1}{24} + \frac{1}{120} + \frac{1}{720} + \frac{1}{5040} \\ &= \frac{685}{252} = 2.718253968\dots \end{aligned}$$

The true value of e is 2.718281828..., so the approximation has an error of about 3×10^{-5} .

Under the assumption that the accuracy of the approximation improves with n (an assumption we examine in Subsection 9.6 below) we can see that the approximation of e above can be improved by adding more and more terms. Indeed this is how the expression for e in equation (3.5.2) in Section 3.5 comes about.

Example 9.5.1

Now that we have examined Maclaurin polynomials for e^x we should take a look at $\log x$. Notice that we cannot compute a Maclaurin polynomial for $\log x$ since it is not defined at $x = 0$.

Example 9.5.2

Compute the 5th Taylor polynomial for $\log x$ about $x = 1$.

Solution. We have been told $a = 1$ and fifth degree, so we should start by writing down the function and its first five derivatives:

$$\begin{array}{ll} f(x) = \log x & f(1) = \log 1 = 0 \\ f'(x) = \frac{1}{x} & f'(1) = 1 \\ f''(x) = \frac{-1}{x^2} & f''(1) = -1 \\ f'''(x) = \frac{2}{x^3} & f'''(1) = 2 \\ f^{(4)}(x) = \frac{-6}{x^4} & f^{(4)}(1) = -6 \\ f^{(5)}(x) = \frac{24}{x^5} & f^{(5)}(1) = 24 \end{array}$$

Substituting this into equation (9.4.2) gives

$$\begin{aligned} T_5(x) &= 0 + 1 \cdot (x-1) + \frac{1}{2} \cdot (-1) \cdot (x-1)^2 + \frac{1}{6} \cdot 2 \cdot (x-1)^3 + \frac{1}{24} \cdot (-6) \cdot (x-1)^4 + \frac{1}{120} \cdot 24 \cdot (x-1)^5 \\ &= (x-1) - \frac{1}{2}(x-1)^2 + \frac{1}{3}(x-1)^3 - \frac{1}{4}(x-1)^4 + \frac{1}{5}(x-1)^5 \end{aligned}$$

Again, it is not too hard to generalise the above work to find the Taylor polynomial of degree n : With a little work one can show that

$$T_n(x) = \sum_{k=1}^n \frac{(-1)^{k+1}}{k} (x-1)^k.$$

Example 9.5.2

For cosine:

Example 9.5.3

Find the 4th degree Maclaurin polynomial for $\cos x$.

Solution. We have $a = 0$ and we need to find the first 4 derivatives of $\cos x$.

$$\begin{array}{ll} f(x) = \cos x & f(0) = 1 \\ f'(x) = -\sin x & f'(0) = 0 \\ f''(x) = -\cos x & f''(0) = -1 \\ f'''(x) = \sin x & f'''(0) = 0 \\ f^{(4)}(x) = \cos x & f^{(4)}(0) = 1 \end{array}$$

Substituting this into equation (9.4.2) gives

$$\begin{aligned} T_4(x) &= 1 + 1 \cdot (0) \cdot x + \frac{1}{2} \cdot (-1) \cdot x^2 + \frac{1}{6} \cdot 0 \cdot x^3 + \frac{1}{24} \cdot (1) \cdot x^4 \\ &= 1 - \frac{x^2}{2} + \frac{x^4}{24} \end{aligned}$$

Notice that since the 4th derivative of $\cos x$ is $\cos x$ again, we also have that the fifth derivative is the same as the first derivative, and the sixth derivative is the same as the second derivative and so on. Hence the next four derivatives are

$$\begin{array}{ll} f^{(4)}(x) = \cos x & f^{(4)}(0) = 1 \\ f^{(5)}(x) = -\sin x & f^{(5)}(0) = 0 \\ f^{(6)}(x) = -\cos x & f^{(6)}(0) = -1 \\ f^{(7)}(x) = \sin x & f^{(7)}(0) = 0 \\ f^{(8)}(x) = \cos x & f^{(8)}(0) = 1 \end{array}$$

Using this we can find the 8th degree Maclaurin polynomial:

$$T_8(x) = 1 - \frac{x^2}{2} + \frac{x^4}{24} - \frac{x^6}{6!} + \frac{x^8}{8!}$$

Continuing this process gives us the $2n^{\text{th}}$ Maclaurin polynomial

$$T_{2n}(x) = \sum_{k=0}^n \frac{(-1)^k}{(2k)!} \cdot x^{2k}$$

Warning 9.5.4.

The above formula only works when x is measured in radians, because all of our derivative formulae for trig functions were developed under the assumption that angles are measured in radians.

Below we plot $\cos x$ against its first few Maclaurin polynomial approximations:

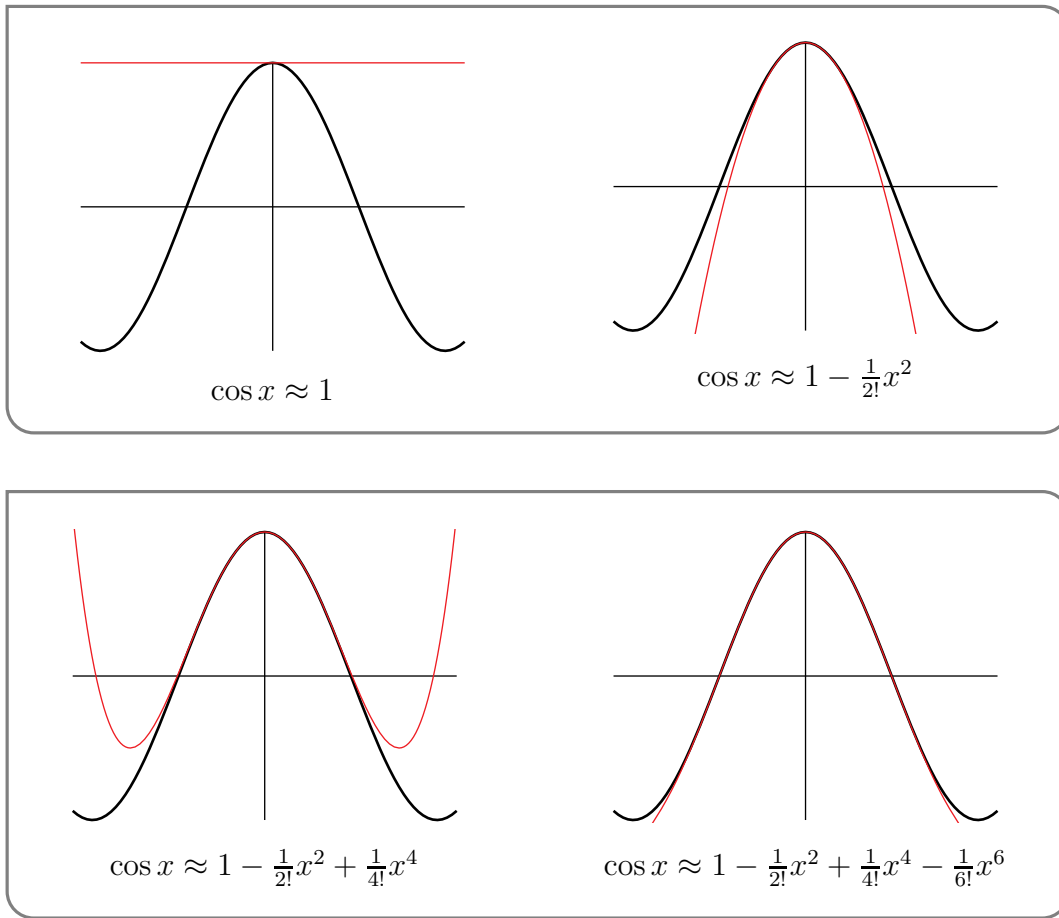

Example 9.5.4

The above work is quite easily recycled to get the Maclaurin polynomial for sine:

Example 9.5.5

Find the 5th degree Maclaurin polynomial for $\sin x$.

Solution. We could simply work as before and compute the first five derivatives of $\sin x$. But set $g(x) = \sin x$ and notice that $g(x) = -f'(x)$, where $f(x) = \cos x$. Then we have

$$\begin{aligned}
 g(0) &= -f'(0) = 0 \\
 g'(0) &= -f''(0) = 1 \\
 g''(0) &= -f'''(0) = 0 \\
 g'''(0) &= -f^{(4)}(0) = -1 \\
 g^{(4)}(0) &= -f^{(5)}(0) = 0 \\
 g^{(5)}(0) &= -f^{(6)}(0) = 1
 \end{aligned}$$

Hence the required Maclaurin polynomial is

$$T_5(x) = x - \frac{x^3}{3!} + \frac{x^5}{5!}$$

Just as we extended to the $2n^{\text{th}}$ Maclaurin polynomial for cosine, we can also extend our work to compute the $(2n + 1)^{\text{th}}$ Maclaurin polynomial for sine:

$$T_{2n+1}(x) = \sum_{k=0}^n \frac{(-1)^k}{(2k+1)!} \cdot x^{2k+1}$$

Warning 9.5.6.

The above formula only works when x is measured in radians, because all of our derivative formulae for trig functions were developed under the assumption that angles are measured in radians.

Below we plot $\sin x$ against its first few Maclaurin polynomial approximations.

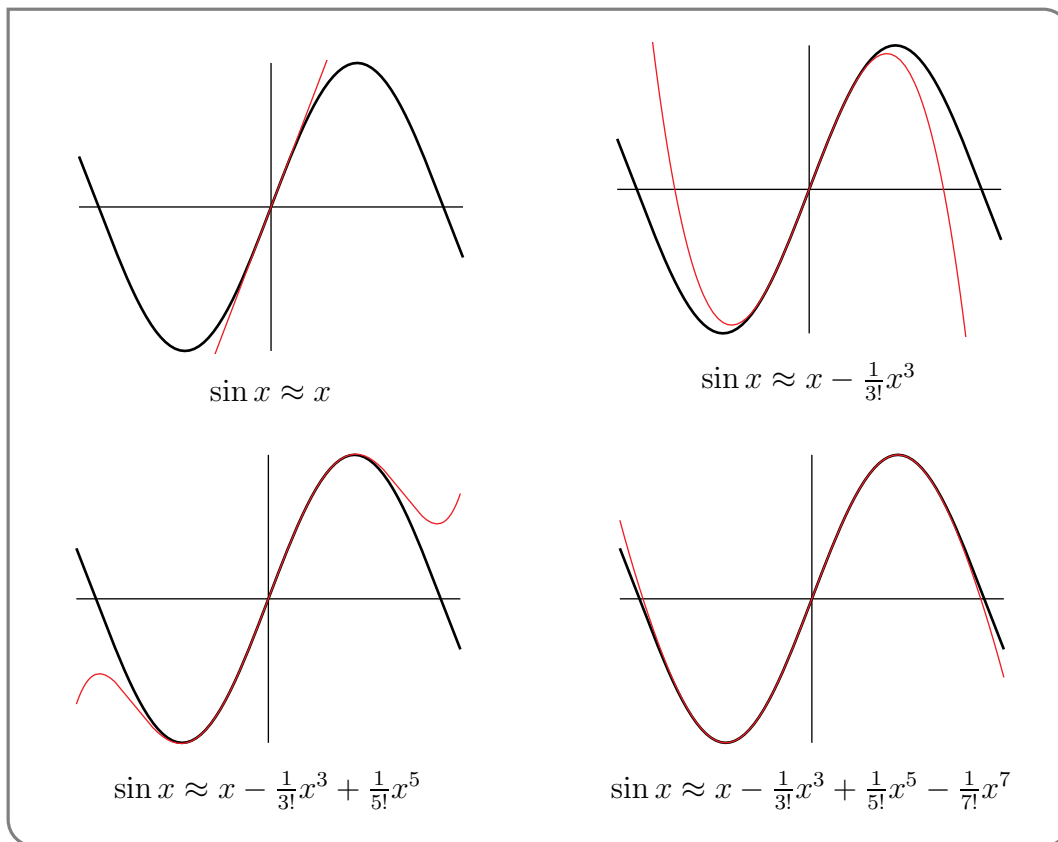

Example 9.5.6

To get an idea of how good these Taylor polynomials are at approximating \sin and \cos , let's concentrate on $\sin x$ and consider x 's whose magnitude $|x| \leq 1$. There are tricks that you can employ¹³ to evaluate sine and cosine at values of x outside this range.

If $|x| \leq 1$ radians¹⁴, then the magnitudes of the successive terms in the Taylor polynomials for

13 If you are writing software to evaluate $\sin x$, you can always use the trig identity $\sin(x) = \sin(x - 2n\pi)$, to easily restrict to $|x| \leq \pi$. You can then use the trig identity $\sin(x) = -\sin(x \pm \pi)$ to reduce to $|x| \leq \frac{\pi}{2}$. Finally you can use the trig identity $\sin(x) = \mp \cos(\frac{\pi}{2} \pm x)$ to reduce to $|x| \leq \frac{\pi}{4} < 1$.

14 Recall that the derivative formulae that we used to derive the Taylor polynomials are valid only when x is in radians. The restriction $-1 \leq x \leq 1$ radians translates to angles bounded by $\frac{180}{\pi} \approx 57^\circ$.

$\sin x$ are bounded by

$$\begin{array}{lll} |x| \leq 1 & \frac{1}{3!}|x|^3 \leq \frac{1}{6} & \frac{1}{5!}|x|^5 \leq \frac{1}{120} \approx 0.0083 \\ \frac{1}{7!}|x|^7 \leq \frac{1}{7!} \approx 0.0002 & \frac{1}{9!}|x|^9 \leq \frac{1}{9!} \approx 0.000003 & \frac{1}{11!}|x|^{11} \leq \frac{1}{11!} \approx 0.000000025 \end{array}$$

From these inequalities, and the graphs on the previous pages, it certainly looks like, for x not too large, even relatively low degree Taylor polynomials give very good approximations. In Section 9.6 we'll see how to get rigorous error bounds on our Taylor polynomial approximations.

9.6 ▲ (Flavour A) Error in Taylor Polynomials

Learning Objectives

- Be able to use the formula for the error in Taylor polynomial approximations, and interpret its result. For example: determine a bound on the error of a polynomial approximation at a point; determine a range for which a particular approximation has an error within a certain tolerance; or determine which degree Taylor approximation will result in an error within a certain tolerance.

Any time you make an approximation, it is desirable to have some idea of the size of the error you introduced. That is, we would like to know the difference $R(x)$ between the original function $f(x)$ and our approximation $F(x)$:

$$R(x) = f(x) - F(x).$$

Of course if we know $R(x)$ exactly, then we could recover $f(x) = F(x) + R(x)$ — so this is an unrealistic hope. In practice we would simply like to bound $R(x)$:

$$|R(x)| = |f(x) - F(x)| \leq M$$

where (hopefully) M is some small number. It is worth stressing that we do not need the tightest possible value of M , we just need a relatively easily computed M that isn't too far off the true value of $|f(x) - F(x)|$.

We will now develop a formula for the error introduced by the constant approximation, equation (9.1.1) (developed back in Section 9.1):

$$f(x) \approx f(a) = T_0(x) \qquad 0^{\text{th}} \text{ Taylor polynomial}$$

The resulting formula can be used to get an upper bound on the size of the error $|R(x)|$. **You'll need to be able to use this formula (and its generalization, which will follow), but you won't be responsible for understanding its derivation.**

Consider the following obvious statement:

$$\begin{aligned}
 f(x) &= f(x) && \text{now some sneaky manipulations} \\
 &= f(a) + (f(x) - f(a)) \\
 &= \underbrace{f(a)}_{=T_0(x)} + (f(x) - f(a)) \cdot \underbrace{\frac{x-a}{x-a}}_{=1} \\
 &= T_0(x) + \underbrace{\frac{f(x) - f(a)}{x-a}}_{\text{looks familiar}} \cdot (x-a)
 \end{aligned}$$

Indeed, this equation is important in the discussion that follows, so we'll highlight it

Equation 9.6.1 (We will need it again soon).

$$f(x) = T_0(x) + \left[\frac{f(x) - f(a)}{x - a} \right] (x - a)$$

The coefficient $\frac{f(x) - f(a)}{x - a}$ of $(x - a)$ is the average slope of $f(t)$ as t moves from $t = a$ to $t = x$. We can picture this as the slope of the secant joining the points $(a, f(a))$ and $(x, f(x))$ in the sketch below.

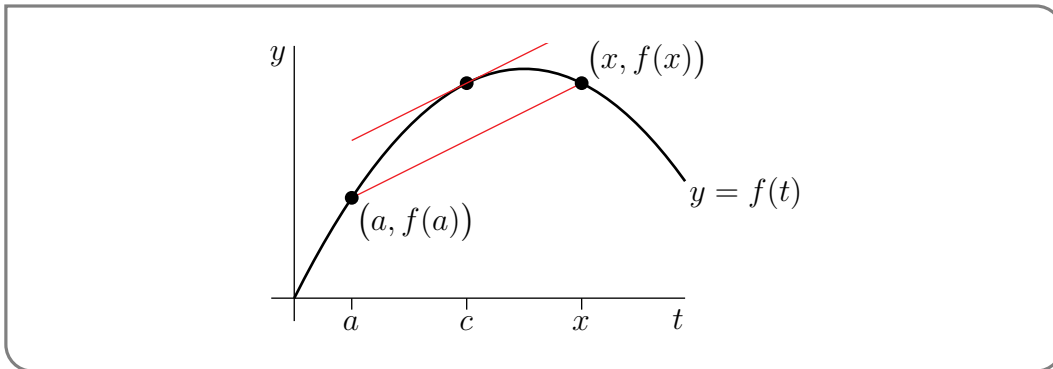

As t moves from a to x , the instantaneous slope $f'(t)$ keeps changing. Sometimes $f'(t)$ might be larger than the average slope $\frac{f(x) - f(a)}{x - a}$, and sometimes $f'(t)$ might be smaller than the average slope $\frac{f(x) - f(a)}{x - a}$. However, by the Mean-Value Theorem (Theorem 9.7.1 – not assessable), there must be some number c , strictly between a and x , for which $f'(c) = \frac{f(x) - f(a)}{x - a}$ exactly.

Substituting this into formula (9.6.1) gives

Equation 9.6.2 (Towards the error).

$$f(x) = T_0(x) + f'(c)(x - a) \quad \text{for some } c \text{ strictly between } a \text{ and } x$$

Notice that this expression as it stands is not quite what we want. Let us massage this around a little more into a more useful form

Equation 9.6.3 (The error in constant approximation).

$$f(x) - T_0(x) = f'(c) \cdot (x - a) \quad \text{for some } c \text{ strictly between } a \text{ and } x$$

Notice that the MVT doesn't tell us the value of c , however we do know that it lies strictly between x and a . So if we can get a good bound on $f'(c)$ on this interval then we can get a good bound on the error.

Example 9.6.4

Let us return to Example 9.1.2, and we'll try to bound the error in our approximation of $e^{0.1}$.

- Recall that $f(x) = e^x$, $a = 0$ and $T_0(x) = e^0 = 1$.
- Then by equation (9.6.3)

$$e^{0.1} - T_0(0.1) = f'(c) \cdot (0.1 - 0) \quad \text{with } 0 < c < 0.1$$

- Now $f'(c) = e^c$, so we need to bound e^c on $(0, 0.1)$. Since e^c is an increasing function, we know that

$$e^0 < f'(c) < e^{0.1} \quad \text{when } 0 < c < 0.1$$

So one is tempted to write that

$$\begin{aligned} |e^{0.1} - T_0(0.1)| &= |R(x)| = |f'(c)| \cdot (0.1 - 0) \\ &< e^{0.1} \cdot 0.1 \end{aligned}$$

And while this is true, it is rather circular. We have just bounded the error in our approximation of $e^{0.1}$ by $\frac{1}{10}e^{0.1}$ — if we actually knew $e^{0.1}$ then we wouldn't need to estimate it!

- While we don't know $e^{0.1}$ exactly, we do know¹⁵ that $1 = e^0 < e^{0.1} < e^1 < 3$. This gives us

$$|R(0.1)| < 3 \times 0.1 = 0.3$$

That is — the error in our approximation of $e^{0.1}$ is no greater than 0.3. Recall that we don't need the error exactly, we just need a good idea of how large it actually is.

- In fact the real error here is

$$|e^{0.1} - T_0(0.1)| = |e^{0.1} - 1| = 0.1051709\dots$$

so we have over-estimated the error by a factor of 3.

But we can actually go a little further here — we can bound the error above and below. If we do not take absolute values, then since

$$e^{0.1} - T_0(0.1) = f'(c) \cdot 0.1 \quad \text{and } 1 < f'(c) < 3$$

we can write

$$1 \times 0.1 \leq (e^{0.1} - T_0(0.1)) \leq 3 \times 0.1$$

so

$$\begin{aligned} T_0(0.1) + 0.1 &\leq e^{0.1} \leq T_0(0.1) + 0.3 \\ 1.1 &\leq e^{0.1} \leq 1.3 \end{aligned}$$

So while the upper bound is weak, the lower bound is quite tight.

Example 9.6.4

There are formulae similar to equation (9.6.2), that can be used to bound the error in our other approximations; all are based on generalisations of the MVT. The next one — for linear approximations — is

$$f(x) = \underbrace{f(a) + f'(a)(x-a)}_{=T_1(x)} + \frac{1}{2}f''(c)(x-a)^2 \quad \text{for some } c \text{ strictly between } a \text{ and } x$$

which we can rewrite in terms of $T_1(x)$:

Equation 9.6.5 (The error in linear approximation).

$$f(x) - T_1(x) = \frac{1}{2}f''(c)(x-a)^2 \quad \text{for some } c \text{ strictly between } a \text{ and } x$$

It implies that the error that we make when we approximate $f(x)$ by $T_1(x) = f(a) + f'(a)(x-a)$ is exactly $\frac{1}{2}f''(c)(x-a)^2$ for some c strictly between a and x .

More generally

$$f(x) = \underbrace{f(a) + f'(a) \cdot (x-a) + \cdots + \frac{1}{n!}f^{(n)}(a) \cdot (x-a)^n}_{=T_n(x)} + \frac{1}{(n+1)!}f^{(n+1)}(c) \cdot (x-a)^{n+1}$$

for some c strictly between a and x . Again, rewriting this in terms of $T_n(x)$ gives

Equation 9.6.6.

$$f(x) - T_n(x) = \frac{1}{(n+1)!}f^{(n+1)}(c) \cdot (x-a)^{n+1} \quad \text{for some } c \text{ strictly between } a \text{ and } x$$

That is, the error introduced when $f(x)$ is approximated by its Taylor polynomial of degree n , is precisely the last term of the Taylor polynomial of degree $n + 1$, but with the derivative evaluated at some point between a and x , rather than exactly at a . These error formulae are proven in the optional Section 9.7 later in this chapter.

Example 9.6.7

Approximate $\sin 46^\circ$ using Taylor polynomials about $a = 45^\circ$, and estimate the resulting error.

Solution.

- Start by defining $f(x) = \sin x$ and

$$a = 45^\circ = 45 \frac{\pi}{180} \text{radians} \quad x = 46^\circ = 46 \frac{\pi}{180} \text{radians} \quad x - a = \frac{\pi}{180} \text{radians}$$

- The first few derivatives of f at a are

$$\begin{aligned} f(x) &= \sin x & f(a) &= \frac{1}{\sqrt{2}} \\ f'(x) &= \cos x & f'(a) &= \frac{1}{\sqrt{2}} \\ f''(x) &= -\sin x & f''(a) &= -\frac{1}{\sqrt{2}} \\ f^{(3)}(x) &= -\cos x & f^{(3)}(a) &= -\frac{1}{\sqrt{2}} \end{aligned}$$

- The constant, linear and quadratic Taylor approximations for $\sin(x)$ about $\frac{\pi}{4}$ are

$$\begin{aligned} T_0(x) &= f(a) & &= \frac{1}{\sqrt{2}} \\ T_1(x) &= T_0(x) + f'(a) \cdot (x - a) & &= \frac{1}{\sqrt{2}} + \frac{1}{\sqrt{2}} \left(x - \frac{\pi}{4}\right) \\ T_2(x) &= T_1(x) + \frac{1}{2} f''(a) \cdot (x - a)^2 & &= \frac{1}{\sqrt{2}} + \frac{1}{\sqrt{2}} \left(x - \frac{\pi}{4}\right) - \frac{1}{2\sqrt{2}} \left(x - \frac{\pi}{4}\right)^2 \end{aligned}$$

- So the approximations for $\sin 46^\circ$ are

$$\begin{aligned} \sin 46^\circ &\approx T_0\left(\frac{46\pi}{180}\right) = \frac{1}{\sqrt{2}} & &= 0.70710678 \\ \sin 46^\circ &\approx T_1\left(\frac{46\pi}{180}\right) = \frac{1}{\sqrt{2}} + \frac{1}{\sqrt{2}} \left(\frac{\pi}{180}\right) & &= 0.71944812 \\ \sin 46^\circ &\approx T_2\left(\frac{46\pi}{180}\right) = \frac{1}{\sqrt{2}} + \frac{1}{\sqrt{2}} \left(\frac{\pi}{180}\right) - \frac{1}{2\sqrt{2}} \left(\frac{\pi}{180}\right)^2 & &= 0.71934042 \end{aligned}$$

- The errors in those approximations are (respectively)

$$\text{error in } 0.70710678 = f'(c)(x-a) = \cos c \cdot \left(\frac{\pi}{180}\right)$$

$$\text{error in } 0.71944812 = \frac{1}{2}f''(c)(x-a)^2 = -\frac{1}{2} \cdot \sin c \cdot \left(\frac{\pi}{180}\right)^2$$

$$\text{error in } 0.71923272 = \frac{1}{3!}f^{(3)}(c)(x-a)^3 = -\frac{1}{3!} \cdot \cos c \cdot \left(\frac{\pi}{180}\right)^3$$

In each of these three cases c must lie somewhere between 45° and 46° .

- Rather than carefully estimating $\sin c$ and $\cos c$ for c in that range, we make use of a simpler (but much easier bound). No matter what c is, we know that $|\sin c| \leq 1$ and $|\cos c| \leq 1$. Hence

$$|\text{error in } 0.70710678| \leq \left(\frac{\pi}{180}\right) < 0.018$$

$$|\text{error in } 0.71944812| \leq \frac{1}{2} \left(\frac{\pi}{180}\right)^2 < 0.00015$$

$$|\text{error in } 0.71934042| \leq \frac{1}{3!} \left(\frac{\pi}{180}\right)^3 < 0.0000009$$

Example 9.6.7

Example 9.6.8 (Showing $e < 3$)

In Example 9.6.4 above we used the fact that $e < 3$ without actually proving it. Let's do so now.

- Consider the linear approximation of e^x about $a = 0$.

$$T_1(x) = f(0) + f'(0) \cdot x = 1 + x$$

So at $x = 1$ we have

$$e \approx T_1(1) = 2$$

- The error in this approximation is

$$e^x - T_1(x) = \frac{1}{2}f''(c) \cdot x^2 = \frac{e^c}{2} \cdot x^2$$

So at $x = 1$ we have

$$e - T_1(1) = \frac{e^c}{2}$$

where $0 < c < 1$.

- Now since e^x is an increasing¹⁶ function, it follows that $e^c < e$. Hence

$$e - T_1(1) = \frac{e^c}{2} < \frac{e}{2}$$

Moving the $\frac{e}{2}$ to the left hand side and the $T_1(1)$ to the right hand side gives

$$\frac{e}{2} \leq T_1(1) = 2$$

So $e < 4$.

- This isn't as tight as we would like — so now do the same with the quadratic approximation with $a = 0$:

$$e^x \approx T_2(x) = 1 + x + \frac{x^2}{2}$$

So when $x = 1$ we have

$$e \approx T_2(1) = 1 + 1 + \frac{1}{2} = \frac{5}{2}$$

- The error in this approximation is

$$e^x - T_2(x) = \frac{1}{3!} f'''(c) \cdot x^3 = \frac{e^c}{6} \cdot x^3$$

So at $x = 1$ we have

$$e - T_2(1) = \frac{e^c}{6}$$

where $0 < c < 1$.

- Again since e^x is an increasing function we have $e^c < e$. Hence

$$e - T_2(1) = \frac{e^c}{6} < \frac{e}{6}$$

That is

$$\frac{5e}{6} < T_2(1) = \frac{5}{2}$$

So $e < 3$ as required.

Example 9.6.8

Example 9.6.9 (More on e^x)

We wrote down the general n^{th} degree Maclaurin polynomial approximation of e^x in Example 9.5.1 above.

- Recall that

$$T_n(x) = \sum_{k=0}^n \frac{1}{k!} x^k$$

- The error in this approximation is (by equation (9.6.6))

$$e^x - T_n(x) = \frac{1}{(n+1)!} e^c$$

where c is some number between 0 and x .

- So setting $x = 1$ in this gives

$$e - T_n(1) = \frac{1}{(n+1)!} e^c$$

where $0 < c < 1$.

- Since e^x is an increasing function we know that $1 = e^0 < e^c < e^1 < 3$, so the above expression becomes

$$\frac{1}{(n+1)!} \leq e - T_n(1) = \frac{1}{(n+1)!} e^c \leq \frac{3}{(n+1)!}$$

- So when $n = 9$ we have

$$\frac{1}{10!} \leq e - \left(1 + 1 + \frac{1}{2} + \cdots + \frac{1}{9!}\right) \leq \frac{3}{10!}$$

- Now $1/10! < 3/10! < 10^{-6}$, so the approximation of e by

$$e \approx 1 + 1 + \frac{1}{2} + \cdots + \frac{1}{9!} = \frac{98641}{36288} = 2.718281\dots$$

is correct to 6 decimal places.

- More generally we know that using $T_n(1)$ to approximate e will have an error of at most $\frac{3}{(n+1)!}$ — so it converges very quickly.

Example 9.6.9

9.7 ▲ (Optional) — Derivation of the error formulae

In this section we will derive the formula for the error that we gave in equation (9.6.6) — namely

$$R_n(x) = f(x) - T_n(x) = \frac{1}{(n+1)!} f^{(n+1)}(c) \cdot (x-a)^{n+1}$$

for some c strictly between a and x , and where $T_n(x)$ is the n^{th} degree Taylor polynomial approximation of $f(x)$ about $x = a$:

$$T_n(x) = \sum_{k=0}^n \frac{1}{k!} f^{(k)}(a).$$

One useful theorem is the Mean Value Theorem, MVT. We will not prove it here.

Theorem 9.7.1 (The mean value theorem).

Let a and b be real numbers with $a < b$. And let $f(x)$ be a function so that

- $f(x)$ is continuous on the closed interval $a \leq x \leq b$, and
- $f(x)$ is differentiable on the open interval $a < x < b$

then there is a $c \in (a, b)$, such that

$$f'(c) = \frac{f(b) - f(a)}{b - a}$$

which we can also express as

$$f(b) = f(a) + f'(c)(b - a).$$

15 Oops! Do we really know that $e < 3$? We haven't proved it. We will do so soon.

16 Since the derivative of e^x is e^x which is positive everywhere, the function is increasing everywhere.

Theorem 9.7.2 (Generalised Mean-Value Theorem).

Let the functions $F(x)$ and $G(x)$ both be defined and continuous on $a \leq x \leq b$ and both be differentiable on $a < x < b$. Furthermore, suppose that $G'(x) \neq 0$ for all $a < x < b$. Then, there is a number c obeying $a < c < b$ such that

$$\frac{F(b) - F(a)}{G(b) - G(a)} = \frac{F'(c)}{G'(c)}$$

Notice that setting $G(x) = x$ recovers the original Mean-Value Theorem. It turns out that this theorem is not too difficult to prove from the MVT using some sneaky algebraic manipulations:

Proof. • First we construct a new function $h(x)$ as a linear combination of $F(x)$ and $G(x)$ so that $h(a) = h(b) = 0$. Some experimentation yields

$$h(x) = [F(b) - F(a)] \cdot [G(x) - G(a)] - [G(b) - G(a)] \cdot [F(x) - F(a)]$$

- Since $h(a) = h(b) = 0$, the Mean-Value theorem (actually Rolle's theorem) tells us that there is a number c obeying $a < c < b$ such that $h'(c) = 0$:

$$\begin{aligned} h'(x) &= [F(b) - F(a)] \cdot G'(x) - [G(b) - G(a)] \cdot F'(x) && \text{so} \\ 0 &= [F(b) - F(a)] \cdot G'(c) - [G(b) - G(a)] \cdot F'(c) \end{aligned}$$

Now move the $G'(c)$ terms to one side and the $F'(c)$ terms to the other:

$$[F(b) - F(a)] \cdot G'(c) = [G(b) - G(a)] \cdot F'(c).$$

- Since we have $G'(x) \neq 0$, we know that $G'(c) \neq 0$. Further the Mean-Value theorem ensures¹⁷ that $G(a) \neq G(b)$. Hence we can move terms about to get

$$\begin{aligned} [F(b) - F(a)] &= [G(b) - G(a)] \cdot \frac{F'(c)}{G'(c)} \\ \frac{F(b) - F(a)}{G(b) - G(a)} &= \frac{F'(c)}{G'(c)} \end{aligned}$$

as required. □

Armed with the above theorem we can now move on to the proof of the Taylor remainder formula.

Proof of equation (9.6.6). We begin by proving the remainder formula for $n = 1$. That is

$$f(x) - T_1(x) = \frac{1}{2} f''(c) \cdot (x - a)^2$$

- Start by setting

$$F(x) = f(x) - T_1(x) \qquad G(x) = (x-a)^2$$

Notice that, since $T_1(a) = f(a)$ and $T_1'(x) = f'(a)$,

$$\begin{aligned} F(a) &= 0 & G(a) &= 0 \\ F'(x) &= f'(x) - f'(a) & G'(x) &= 2(x-a) \end{aligned}$$

- Now apply the generalised MVT with $b = x$: there exists a point q between a and x such that

$$\begin{aligned} \frac{F(x) - F(a)}{G(x) - G(a)} &= \frac{F'(q)}{G'(q)} \\ \frac{F(x) - 0}{G(x) - 0} &= \frac{f'(q) - f'(a)}{2(q-a)} \\ 2 \cdot \frac{F(x)}{G(x)} &= \frac{f'(q) - f'(a)}{q-a} \end{aligned}$$

- Consider the right-hand side of the above equation and set $g(x) = f'(x)$. Then we have the term $\frac{g(q)-g(a)}{q-a}$ — this is exactly the form needed to apply the MVT. So now apply the standard MVT to the right-hand side of the above equation — there is some c between q and a so that

$$\frac{f'(q) - f'(a)}{q-a} = \frac{g(q) - g(a)}{q-a} = g'(c) = f''(c)$$

Notice that here we have assumed that $f''(x)$ exists.

- Putting this together we have that

$$\begin{aligned} 2 \cdot \frac{F(x)}{G(x)} &= \frac{f'(q) - f'(a)}{q-a} = f''(c) \\ 2 \frac{f(x) - T_1(x)}{(x-a)^2} &= f''(c) \\ f(x) - T_1(x) &= \frac{1}{2!} f''(c) \cdot (x-a)^2 \end{aligned}$$

as required.

Oof! We have now proved the cases $n = 1$ (and we did $n = 0$ earlier).

To proceed — assume we have proved our result for $n = 1, 2, \dots, k$. We realise that we haven't done this yet, but bear with us. Using that assumption we will prove the result is true for $n = k + 1$. Once we have done that, then

- we have proved the result is true for $n = 1$, and
- we have shown if the result is true for $n = k$ then it is true for $n = k + 1$

Hence it must be true for all $n \geq 1$. This style of proof is called mathematical induction. You can think of the process as something like climbing a ladder:

- prove that you can get onto the ladder (the result is true for $n = 1$), and
- if I can stand on the current rung, then I can step up to the next rung (if the result is true for $n = k$ then it is also true for $n = k + 1$)

Hence I can climb as high as like.

- Let $k > 0$ and assume we have proved

$$f(x) - T_k(x) = \frac{1}{(k+1)!} f^{(k+1)}(c) \cdot (x-a)^{k+1}$$

for some c between a and x .

- Now set

$$F(x) = f(x) - T_{k+1}(x) \quad G(x) = (x-a)^{k+1}$$

and notice that, since $T_{k+1}(a) = f(a)$,

$$F(a) = f(a) - T_{k+1}(a) = 0 \quad G(a) = 0 \quad G'(x) = (k+1)(x-a)^k$$

and apply the generalised MVT with $b = x$: hence there exists a q between a and x so that

$$\begin{aligned} \frac{F(x) - F(a)}{G(x) - G(a)} &= \frac{F'(q)}{G'(q)} && \text{which becomes} \\ \frac{F(x)}{(x-a)^{k+1}} &= \frac{F'(q)}{(k+1)(q-a)^k} && \text{rearrange} \\ F(x) &= \frac{(x-a)^{k+1}}{(k+1)(q-a)^k} \cdot F'(q) \end{aligned}$$

- We now examine $F'(q)$. First carefully differentiate $F(x)$:

$$\begin{aligned} F'(x) &= \frac{d}{dx} \left[f(x) - \left(f(a) + f'(a)(x-a) + \frac{1}{2}f''(a)(x-a)^2 + \cdots + \frac{1}{k!}f^{(k)}(a)(x-a)^k \right) \right] \\ &= f'(x) - \left(f'(a) + \frac{2}{2}f''(a)(x-a) + \frac{3}{3!}f'''(a)(x-a)^2 + \cdots + \frac{k}{k!}f^{(k)}(a)(x-a)^{k-1} \right) \\ &= f'(x) - \left(f'(a) + f''(a)(x-a) + \frac{1}{2}f'''(a)(x-a)^2 + \cdots + \frac{1}{(k-1)!}f^{(k)}(a)(x-a)^{k-1} \right) \end{aligned}$$

Now notice that if we set $f'(x) = g(x)$ then this becomes

$$F'(x) = g(x) - \left(g(a) + g'(a)(x-a) + \frac{1}{2}g''(a)(x-a)^2 + \cdots + \frac{1}{(k-1)!}g^{(k-1)}(a)(x-a)^{k-1} \right)$$

So $F'(x)$ is then exactly the remainder formula but for a degree $k - 1$ approximation to the function $g(x) = f'(x)$.

- Hence the function $F'(q)$ is the remainder when we approximate $f'(q)$ with a degree $k-1$ Taylor polynomial. The remainder formula, equation (9.6.6), then tells us that there is a number c between a and q so that

$$\begin{aligned} F'(q) &= g(q) - \left(g(a) + g'(a)(q-a) + \frac{1}{2}g''(a)(q-a)^2 + \cdots + \frac{1}{(k-1)!}g^{(k-1)}(a)(q-a)^{k-1} \right) \\ &= \frac{1}{k!}g^{(k)}(c)(q-a)^k = \frac{1}{k!}f^{(k+1)}(c)(q-a)^k \end{aligned}$$

Notice that here we have assumed that $f^{(k+1)}(x)$ exists.

- Now substitute this back into our equation above

$$\begin{aligned} F(x) &= \frac{(x-a)^{k+1}}{(k+1)(q-a)^k} \cdot F'(q) \\ &= \frac{(x-a)^{k+1}}{(k+1)(q-a)^k} \cdot \frac{1}{k!}f^{(k+1)}(c)(q-a)^k \\ &= \frac{1}{(k+1)k!} \cdot f^{(k+1)}(c) \cdot \frac{(x-a)^{k+1}(q-a)^k}{(q-a)^k} \\ &= \frac{1}{(k+1)!} \cdot f^{(k+1)}(c) \cdot (x-a)^{k+1} \end{aligned}$$

as required.

So we now know that

- if, for some k , the remainder formula (with $n = k$) is true for all k times differentiable functions,
- then the remainder formula is true (with $n = k + 1$) for all $k + 1$ times differentiable functions.

Repeatedly applying this for $k = 1, 2, 3, 4, \dots$ (and recalling that we have shown the remainder formula is true when $n = 0, 1$) gives equation (9.6.6) for all $n = 0, 1, 2, \dots$ \square

Chapter 10

(FLAVOUR A) NEWTON'S METHOD**Learning Objectives**

- Given a function, find an integer that is reasonably close to the root.
- Given a differentiable function, find the x -intercept of the tangent line at a particular point.
- Explain how Newton's method works. That is, how you can use tangent lines to approximate the roots of a function.
- Write down the formula for Newton's method and explain what each term in the equation represents.
- Use Newton's method to estimate the root(s) of a function.
- Recognize pathological cases where Newton's Method doesn't converge to a root.

Newton's method¹, also known as the Newton-Raphson method, is another technique for generating numerical approximate solutions to equations of the form $f(x) = 0$. For example, one can easily get a good approximation to $\sqrt{2}$ by applying Newton's method to the equation $x^2 - 2 = 0$. This will be done in Example 10.0.2, below.

Here is the derivation of Newton's method. We start by simply making a guess for the solution. For example, we could base the guess on a sketch of the graph of $f(x)$. Call the initial guess x_1 . Next recall, from Theorem 3.3.7, that the tangent line to $y = f(x)$ at $x = x_1$ is $y = F(x)$, where

$$F(x) = f(x_1) + f'(x_1)(x - x_1)$$

0 Otherwise if $G(a) = G(b)$ the MVT tells us that there is some point c between a and b so that $G'(c) = 0$.

1 The algorithm that we are about to describe grew out of a method that Newton wrote about in 1669. But the modern method incorporates substantial changes introduced by Raphson in 1690 and Simpson in 1740.

Usually $F(x)$ is a pretty good approximation to $f(x)$ for x near x_1 . So, instead of trying to solve $f(x) = 0$, we solve the linear equation $F(x) = 0$ and call the solution x_2 .

$$\begin{aligned} 0 = F(x) = f(x_1) + f'(x_1)(x - x_1) &\iff x - x_1 = -\frac{f(x_1)}{f'(x_1)} \\ &\iff x = x_2 = x_1 - \frac{f(x_1)}{f'(x_1)} \end{aligned}$$

Note that if $f(x)$ were a linear function, then $F(x)$ would be exactly $f(x)$ and x_2 would solve $f(x) = 0$ exactly.

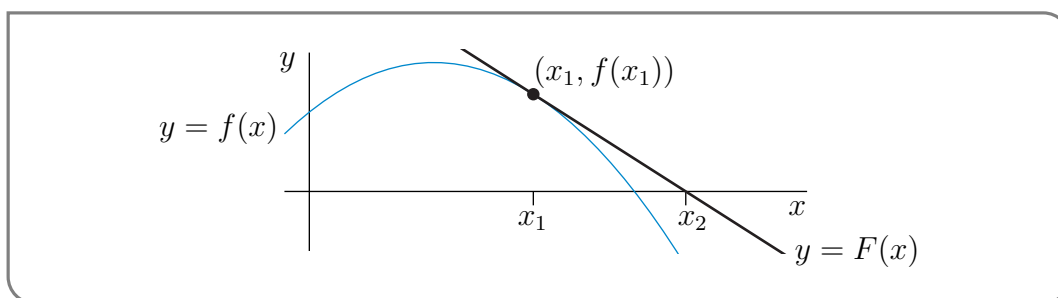

Now we repeat, but starting with the (second) guess x_2 rather than x_1 . This gives the (third) guess $x_3 = x_2 - \frac{f(x_2)}{f'(x_2)}$. And so on. By way of summary, Newton's method is

1. Make a preliminary guess x_1 .
2. Define $x_2 = x_1 - \frac{f(x_1)}{f'(x_1)}$.
3. Iterate. That is, for each natural number n , once you have computed x_n , define

Equation 10.0.1 (Newton's method).

$$x_{n+1} = x_n - \frac{f(x_n)}{f'(x_n)}$$

Example 10.0.2 (Approximating $\sqrt{2}$)

In this example we compute, approximately, the square root of two. We will of course pretend that we do not already know that $\sqrt{2} = 1.41421 \dots$. So we cannot find it by solving, approximately, the equation $f(x) = x - \sqrt{2} = 0$. Instead we apply Newton's method to the equation

$$f(x) = x^2 - 2 = 0$$

Since $f'(x) = 2x$, Newton's method says that we should generate approximate solutions by iteratively applying

$$x_{n+1} = x_n - \frac{f(x_n)}{f'(x_n)} = x_n - \frac{x_n^2 - 2}{2x_n} = \frac{x_n}{2} + \frac{1}{x_n}$$

We need a starting point. Since $1^2 = 1 < 2$ and $2^2 = 4 > 2$, the square root of two must be between 1 and 2, so let's start Newton's method with the initial guess $x_1 = 1.5$. Here goes²:

$$\begin{aligned} x_1 &= 1.5 \\ x_2 &= \frac{1}{2}x_1 + \frac{1}{x_1} = \frac{1}{2}(1.5) + \frac{1}{1.5} \\ &= 1.416666667 \\ x_3 &= \frac{1}{2}x_2 + \frac{1}{x_2} = \frac{1}{2}(1.416666667) + \frac{1}{1.416666667} \\ &= 1.414215686 \\ x_4 &= \frac{1}{2}x_3 + \frac{1}{x_3} = \frac{1}{2}(1.414215686) + \frac{1}{1.414215686} \\ &= 1.414213562 \\ x_5 &= \frac{1}{2}x_4 + \frac{1}{x_4} = \frac{1}{2}(1.414213562) + \frac{1}{1.414213562} \\ &= 1.414213562 \end{aligned}$$

It looks like the x_n 's, rounded to nine decimal places, have stabilized to 1.414213562. So it is reasonable to guess that $\sqrt{2}$, rounded to nine decimal places, is exactly 1.414213562. Recalling that all numbers $1.4142135615 \leq y < 1.4142135625$ round to 1.414213562, we can check our guess by evaluating $f(1.4142135615)$ and $f(1.4142135625)$. Since $f(1.4142135615) = -2.5 \times 10^{-9} < 0$ and $f(1.4142135625) = 3.6 \times 10^{-10} > 0$ the square root of two must indeed be between 1.4142135615 and 1.4142135625.

Example 10.0.2

Example 10.0.3 (Approximating π)

In this example we compute, approximately, π by applying Newton's method to the equation

$$f(x) = \sin x = 0$$

starting with $x_1 = 3$. Since $f'(x) = \cos x$, Newton's method says that we should generate approximate solutions by iteratively applying

$$x_{n+1} = x_n - \frac{f(x_n)}{f'(x_n)} = x_n - \frac{\sin x_n}{\cos x_n} = x_n - \tan x_n$$

2 The following computations have been carried out in double precision, which is computer speak for about 15 significant digits. We are displaying each x_n rounded to 10 significant digits (9 decimal places). So each displayed x_n has not been impacted by roundoff error, and still contains more decimal places than are usually needed.

Here goes

$$\begin{aligned}
 x_1 &= 3 \\
 x_2 &= x_1 - \tan x_1 = 3 - \tan 3 \\
 &= 3.142546543 \\
 x_3 &= 3.142546543 - \tan 3.142546543 \\
 &= 3.141592653 \\
 x_4 &= 3.141592653 - \tan 3.141592653 \\
 &= 3.141592654 \\
 x_5 &= 3.141592654 - \tan 3.141592654 \\
 &= 3.141592654
 \end{aligned}$$

Since $f(3.1415926535) = 9.0 \times 10^{-11} > 0$ and $f(3.1415926545) = -9.1 \times 10^{-11} < 0$, π must be between 3.1415926535 and 3.1415926545. Of course to compute π in this way, we (or at least our computers) have to be able to evaluate $\tan x$ for various values of x . Taylor expansions can help us do that.

Example 10.0.3

Example 10.0.4 (wild instability)

This example illustrates how Newton's method can go badly wrong if your initial guess is not good enough. We'll try to solve the equation

$$f(x) = \arctan x = 0$$

starting with $x_1 = 1.5$. (Of course the solution to $f(x) = 0$ is just $x = 0$; we chose $x_1 = 1.5$ for demonstration purposes.) Since the derivative $f'(x) = \frac{1}{1+x^2}$, Newton's method gives

$$x_{n+1} = x_n - \frac{f(x_n)}{f'(x_n)} = x_n - (1 + x_n^2) \arctan x_n$$

So³

$$\begin{aligned}
 x_1 &= 1.5 \\
 x_2 &= 1.5 - (1 + 1.5^2) \arctan 1.5 = -1.69 \\
 x_3 &= -1.69 - (1 + 1.69^2) \arctan(-1.69) = 2.32 \\
 x_4 &= 2.32 - (1 + 2.32^2) \arctan(2.32) = -5.11 \\
 x_5 &= -5.11 - (1 + 5.11^2) \arctan(-5.11) = 32.3 \\
 x_6 &= 32.3 - (1 + 32.3^2) \arctan(32.3) = -1575 \\
 x_7 &= 3,894,976
 \end{aligned}$$

Looks pretty bad! Our x_n 's are not settling down at all!

3 Once again, the following computations have been carried out in double precision. This time, it is clear that the x_n 's are growing madly as n increases. So there is not much point to displaying many decimal places and we have not done so.

The figure below shows what went wrong. In this figure, $y = F_1(x)$ is the tangent line to $y = \arctan x$ at $x = x_1$. Under Newton's method, this tangent line crosses the x -axis at $x = x_2$. Then $y = F_2(x)$ is the tangent to $y = \arctan x$ at $x = x_2$. Under Newton's method, this tangent line crosses the x -axis at $x = x_3$. And so on.

The problem arose because the x_n 's were far enough from the solution, $x = 0$, that the tangent line approximations, while good approximations to $f(x)$ for $x \approx x_n$, were very poor approximations

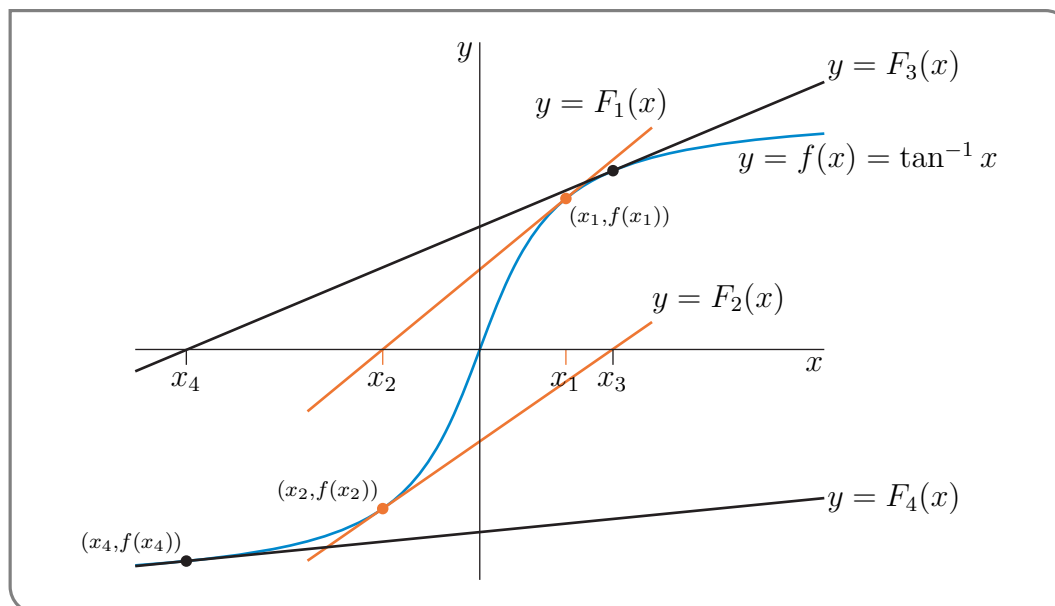

to $f(x)$ for $x \approx 0$. In particular, $y = F_1(x)$ (i.e. the tangent line at $x = x_1$) was a bad enough approximation to $y = \arctan x$ for $x \approx 0$ that $x = x_2$ (i.e. the value of x where $y = F_1(x)$ crosses the x -axis) is farther from the solution $x = 0$ than our original guess $x = x_1$. If we had started with $x_1 = 0.5$ instead of $x_1 = 1.5$, Newton's method would have succeeded very nicely:

$$x_1 = 0.5 \quad x_2 = -0.0796 \quad x_3 = 0.000335 \quad x_4 = -2.51 \times 10^{-11}$$

Example 10.04

Example 10.05 (interest rate)

A car dealer sells a new car for \$23,520. He also offers to finance the same car for payments of \$420 per month for five years. What interest rate is this dealer charging?

Solution. By way of preparation, we'll start with a simpler problem. Suppose that you will have to make a single \$420 payment n months in the future. The simpler problem is to determine how much money you have to deposit now in an account that pays an interest rate of $100r\%$ per month, compounded monthly⁴, in order to be able to make the \$420 payment in n months.

Let's denote by P the initial deposit. Because the interest rate is $100r\%$ per month, compounded monthly,

- the first month's interest is $P \times r$. So at the end of month #1, the account balance is $P + Pr = P(1 + r)$.

4 "Compounded monthly", means that, each month, interest is paid on the accumulated interest that was paid in all previous months.

- The second month's interest is $[P(1+r)] \times r$. So at the end of month #2, the account balance is $P(1+r) + P(1+r)r = P(1+r)^2$.
- And so on.
- So at the end of n months, the account balance is $P(1+r)^n$.

In order for the balance at the end of n months, $P(1+r)^n$, to be \$420, the initial deposit has to be $P = 420(1+r)^{-n}$. That is what is meant by the statement "The present value⁵ of a \$420 payment made n months in the future, when the interest rate is $100r\%$ per month, compounded monthly, is $420(1+r)^{-n}$."

Now back to the original problem. We will be making 60 monthly payments of \$420. The present value of all 60 payments is⁶

$$\begin{aligned} 420(1+r)^{-1} + 420(1+r)^{-2} + \dots + 420(1+r)^{-60} &= 420 \frac{(1+r)^{-1} - (1+r)^{-61}}{1 - (1+r)^{-1}} \\ &= 420 \frac{1 - (1+r)^{-60}}{(1+r) - 1} = 420 \frac{1 - (1+r)^{-60}}{r} \end{aligned}$$

The interest rate $100r\%$ being charged by the car dealer is such that the present value of 60 monthly payments of \$420 is \$23520. That is, the monthly interest rate being charged by the car dealer is the solution of

$$\begin{aligned} 23520 &= 420 \frac{1 - (1+r)^{-60}}{r} & \text{or} & \quad 56 = \frac{1 - (1+r)^{-60}}{r} \\ & & \text{or} & \quad 56r = 1 - (1+r)^{-60} \\ & & \text{or} & \quad 56r(1+r)^{60} = (1+r)^{60} - 1 \\ & & \text{or} & \quad (1 - 56r)(1+r)^{60} = 1 \end{aligned}$$

Set $f(r) = (1 - 56r)(1+r)^{60} - 1$. Then

$$f'(r) = -56(1+r)^{60} + 60(1-56r)(1+r)^{59}$$

or

$$f'(r) = [-56(1+r) + 60(1-56r)](1+r)^{59} = (4 - 3416r)(1+r)^{59}$$

Apply Newton's method with an initial guess of $r_1 = .002$. (That's 0.2% per month or 2.4% per

5 Inflation means that prices of goods (typically) increase with time, and hence \$100 now is worth more than \$100 in 10 years time. The term "present value" is widely used in economics and finance to mean "the current amount of money that will have a specified value at a specified time in the future". It takes inflation into account. If the money is invested, it takes into account the rate of return of the investment. We recommend that the interested reader do some search-engineing to find out more.

6 Don't worry if you don't know how to evaluate such sums. They are called geometric sums, and will be covered in the CLP-2 text. (See (1.1.3) in the CLP-2 text.) In any event, you can check that this is correct, by multiplying the whole equation by $1 - (1+r)^{-1}$. When you simplify the left hand side, you should get the right hand side.

year.) Then

$$r_2 = r_1 - \frac{(1 - 56r_1)(1 + r_1)^{60} - 1}{(4 - 3416r_1)(1 + r_1)^{59}} = 0.002344$$

$$r_3 = r_2 - \frac{(1 - 56r_2)(1 + r_2)^{60} - 1}{(4 - 3416r_2)(1 + r_2)^{59}} = 0.002292$$

$$r_4 = r_3 - \frac{(1 - 56r_3)(1 + r_3)^{60} - 1}{(4 - 3416r_3)(1 + r_3)^{59}} = 0.002290$$

$$r_5 = r_4 - \frac{(1 - 56r_4)(1 + r_4)^{60} - 1}{(4 - 3416r_4)(1 + r_4)^{59}} = 0.002290$$

So the interest rate is 0.229% per month or 2.75% per year.

Example 10.0.5

Differential Equations

Chapter 11

**(FLAVOURS A, B) INTRODUCTION
TO DIFFERENTIAL EQUATIONS****Learning Objectives**

- Explain how a differential equation is different from an algebraic equation.
- Check whether a given function satisfies a differential equation.
- Understand basic differential-equation models of exponential growth and decay.
- Identify solutions to simple differential equations (of the form $y' = ay$) and interpret them in context.
- Given an initial condition, find a particular solution that satisfies a differential equation.

11.1 ▲ Introducing a new kind of equation

 A screencast summary of the introduction: differential equations for exponential growth and decay. Edu.Cr.

►► Observations about the exponential function

Earlier, we introduced the exponential function $y = f(x) = e^x$, and noted that it satisfies the relationship

$$\frac{de^x}{dx} = e^x, \quad \Rightarrow \quad \frac{dy}{dx} = y.$$

The equation on the right (linking a function to its own derivative) is a new kind of equation called a **differential equation** (abbreviated DE). We say that $f(x) = e^x$ is a function that “satisfies” the equation, and we call this a **solution to the differential equation**.

Note: The solution to an algebraic equation is a number, whereas the solution to a differential equation is a function.

We call this a **differential equation** because it connects (one or more) derivatives of a function with the function itself.

Concept Check-In

1. For what constant C does $y = Ce^x$ satisfy the differential equation $dy/dx = y$?
2. What function satisfies the DE $dy/dz = y$?

Definition 11.1.1 (Differential equation). A differential equation is a mathematical equation that relates one or more derivatives of some function to the function itself. Solving the differential equation is the process of identifying the function(s) that satisfies the given relationship.

We will be interested in applications in which a system or process varies over time. For this reason, we will henceforth use the independent variable t , for **time** in place of the former generic “ x ”.

Observations.

1. Consider the function of time: $y = f(t) = e^t$.

Hint

Notice that we merely changed the notation very slightly. Now the derivative is “with respect to” t rather than x .

Show that this function satisfies the differential equation

$$\frac{dy}{dt} = y.$$

2. The functions $y = e^{kt}$ (for k constant) satisfy the differential equation

$$\frac{dy}{dt} = ky. \quad (11.1.1)$$

We can verify by differentiating $y = e^{kt}$, using the chain rule. Setting $u = kt$, and $y = e^u$, we have

$$\frac{dy}{dt} = \frac{dy}{du} \frac{du}{dt} = e^u \cdot k = ke^{kt} = ky \quad \Rightarrow \quad \frac{dy}{dt} = ky$$

Hence, we have established that $y = e^{kt}$ satisfies the DE (11.1.1).

It is interesting to ask: *Is this the only function that satisfies the differential equation 11.1.1? Are there other possible solutions? What about a function such as $y = 2e^{kt}$ or $y = 400e^{kt}$?*

The reader should show that for any constant C , the function $y = Ce^{kt}$ is a solution to the DE (11.1.1).

Hint

Notice that the constant C in front will appear in both the derivative and the function, and so will not change the equation.

To do so, differentiate the function and plug into (11.1.1). Verifying that the two sides of the equation are then the same establishes the result. While we do not prove it here, it turns out that $y = Ce^{kt}$ are the *only* functions that satisfy Eqn. (11.1.1).

Let us summarize what we have found out so far:

Solutions to the differential equation

$$\frac{dy}{dt} = ky \quad (11.1.2)$$

are the functions

$$y = Ce^{kt} \quad (11.1.3)$$

for C an arbitrary constant.

A few comments are in order. First, unlike *algebraic* equations - whose solutions are numbers - **differential equations** have solutions that are *functions*.

Concept Check-In

1. Give an example of an algebraic equation and its solution.
2. Verify that $y = 3e^{-t}$ satisfies differential equation $\frac{dy}{dt} = -y$.
3. Why is e^{kt} always positive?
4. Sketch $y = Ce^t$ for each of $C = -4, -2, 2$ and 4 .
5. Sketch $y = Ce^{-t}$ for each of $C = -4, -2, 2$, and 4 .

Second, the constant k that appears in Eqn. (11.1.2), is the same as the constant k in e^{kt} . Depending on the sign of k , we get either

a) *exponential growth* for $k > 0$, as illustrated in Figure 11.1(a), or

b) *exponential decay* for $k < 0$, as illustrated in Figure 11.1(b).

Third, since e^{kt} is always positive, the constant C determines the sign of the function as a whole - whether its graph lies above or below the t axis.

A few curves of each type ($C > 0, C < 0$) are shown in each panel of Figure 11.1. The collection of curves in a panel is called a **family** of solution curves. The family shares the same value of k , but each member has a distinct value of C . Next, we ask how to specify a particular member of the family as *the* solution.

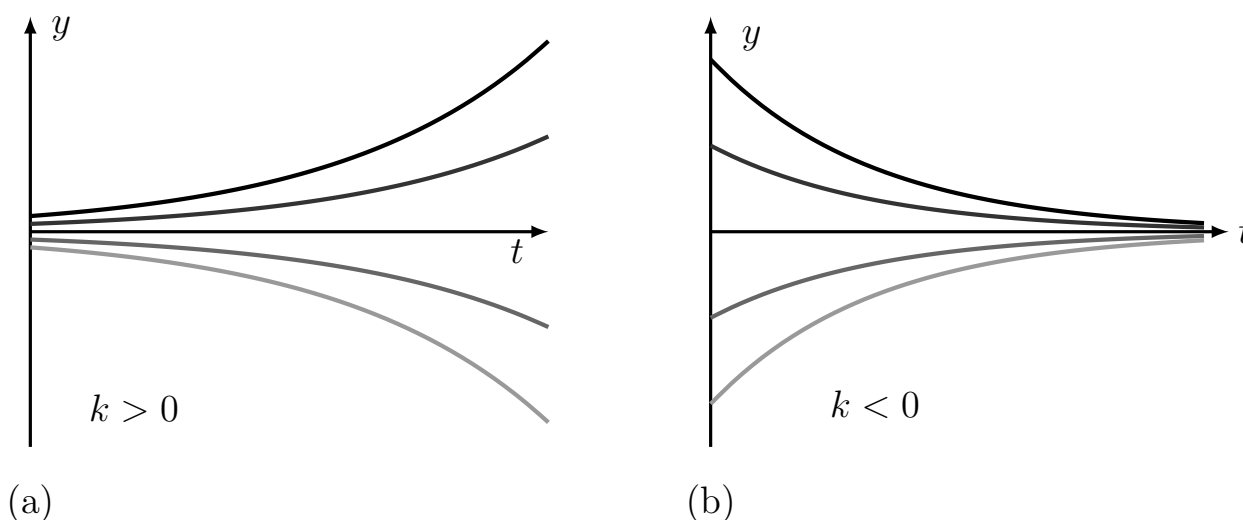

Figure 11.1: (a) A family of solutions to the differential equation (DE) (11.1.2). These are functions of the form $y = Ce^{kt}$ for $k > 0$ and arbitrary constant C . (b) Another family of solutions of a DE of the form (11.1.2), but for $k < 0$.

►► The solution to a differential equation

Definition 11.1.2 (Solution to a differential equation). By a **solution** to a differential equation, we mean a function that satisfies that equation.

We often refer to “solution curves” - the graphs of the family of solutions of a differential equation, as shown, for example in the panels of Figure 11.1.

So far, we found that “many” functions can be valid solutions of the differential equation (11.1.2), since we can choose the constant C arbitrarily in the family of solutions $y = Ce^{kt}$. Hence, in order to distinguish one specific solution of interest, we need additional information. This additional information is called an **initial value**, or **initial condition**, and it specifies one point belonging to the solution curve of interest. A common way to set an initial value is to specify a fixed value of the function (say $y = y_0$) at time $t = 0$.

Definition 11.1.3 (Initial value). An **initial value** for a differential equation is a specified, known value of the solution at some specific time point (usually at time $t = 0$).

 Adjust the sliders in this interactive graph to see how the values of k and C affect the shape of the graph of the function $y = Ce^{kt}$ as well as its initial value $y(0) = y_0$.

Note the transitions that take place when k changes from positive to negative.

Example 11.1.4. Given the differential Eqn. (11.1.2) and the initial value

$$y(0) = y_0,$$

find the value of C for the solution in Eqn. (11.1.3).

Concept Check-In

1. Given differential Eqn. (11.1.2) and the initial value $y(0) = 1$, find C for the solution in Eqn (11.1.3).
2. Repeat the above but for the initial value $y(0) = 10$.
3. Draw the ty -plane with the points $(0, y_0)$ for $y_0 = 1, 10$.
4. Use differentiation to verify that the unction $y = 3e^{-0.5t}$ in Example 11.1.5 is a solution to $dy/dt = -0.5y$ with initial condition $y(0) = 3$.

Solution. We proceed as follows:

$$y(t) = Ce^{kt}, \quad \text{so} \quad y(0) = Ce^{k \cdot 0} = Ce^0 = C \cdot 1 = C.$$

But, by the initial condition, $y(0) = y_0$. So,

$$C = y_0$$

and we have established that

$$y(t) = y_0e^{kt}, \quad \text{where } y_0 \text{ is the initial value.}$$

◇

For example, in Figure 11.1, the initial value specifies that the solution we want passes through a specific point in the ty -plane - namely, the point $(0, y_0)$. Only one curve in the family of curves has that property. Hence, the initial value picks out a unique solution.

Example 11.1.5. Find the solution to the differential equation

$$\frac{dy}{dt} = -0.5y$$

that satisfies the initial condition $y(0) = 3$. Describe the behaviour of the solution you have found.

Solution. The DE indicates that $k = -0.5$, so solutions are exponential functions $y = Ce^{-0.5t}$. The initial condition sets the value of C . From previous discussion, we know that $C = y(0) = 3$. Hence, the solution is $y = 3e^{-0.5t}$. This is a decaying exponential. ◇

11.2 ▲ Differential equation for unlimited population growth

 A screencast summary of the model for (unlimited) human population growth.

Differential equations are important because they turn up in the study of many natural processes that vary continuously. In this section we examine the way that a simple differential equation arises when we study continuous uncontrolled population growth.

Here we set up a mathematical model for population growth. Let $N(t)$ be the number of individuals in a population at time t . The population changes with time due to births and mortality. (Here we ignore migration). Consider the changes that take place in the population size between time t and $t + h$, where $\Delta t = h$ is a small time increment. Then

Concept Check-In

1. What is the dependent variable in this model? The independent variable?
2. What are the units associated with each variable in this model?
3. What does “ x is proportional to y ” mean?

$$N(t+h) - N(t) = \left[\begin{array}{c} \text{Change} \\ \text{in } N \end{array} \right] = \left[\begin{array}{c} \text{Number} \\ \text{of births} \end{array} \right] - \left[\begin{array}{c} \text{Number} \\ \text{of deaths} \end{array} \right] \quad (11.2.1)$$

Eqn. (11.2.1) is just a “book-keeping” equation that keeps track of people entering and leaving the population. It is sometimes called a **balance equation**. We use it to derive a differential equation linking the *derivative* of N to the *value* of N at the given time.

Notice that dividing each term by the time interval h , we obtain

$$\frac{N(t+h) - N(t)}{h} = \left[\frac{\text{Number of births}}{h} \right] - \left[\frac{\text{Number of deaths}}{h} \right].$$

The term on the left “looks familiar”. If we shrink the time interval, $h \rightarrow 0$, this term is a derivative dN/dt , so

$$\frac{dN}{dt} = \left[\begin{array}{c} \text{Rate of} \\ \text{change of} \\ \text{N per unit} \\ \text{time} \end{array} \right] = \left[\begin{array}{c} \text{Number} \\ \text{of births} \\ \text{per unit} \\ \text{time} \end{array} \right] - \left[\begin{array}{c} \text{Number} \\ \text{of deaths} \\ \text{per unit} \\ \text{time} \end{array} \right]$$

For simplicity, we assume that all individuals are identical and that the number of births per unit time is proportional to the population size. Denote by r the constant of proportionality. Similarly, we assume that the number of deaths per unit time is proportional to population size with m the constant of proportionality.

Both r and m have meanings: r is the average **per capita birth rate**, and m is the average **per capita mortality rate**. Here, both are assumed to be fixed positive constants that carry units of $1/\text{time}$. This is required to make the units match for every term in Eqn. (11.2.1). Then

$$r = \text{per capita birth rate} = \frac{\text{number births per unit time}}{\text{population size}},$$

Concept Check-In

1. If there are 10 births/year in a population of size 1000, what is the birth rate r ? Give units.
2. If there are 11 deaths/year in a population of size 1000, what is the mortality rate m ? Give units.
3. Given the above conditions, what is the net growth rate k for such a population? Give units. Is the population growing or shrinking?

$$m = \text{per capita mortality rate} = \frac{\text{number deaths per unit time}}{\text{population size}}.$$

Consequently, we have

$$\begin{aligned}\text{Number of births per unit time} &= rN, \\ \text{Number of deaths per unit time} &= mN.\end{aligned}$$

We refer to constants such as r, m as **parameters**. In general, for a given population, these would have specific numerical values that could be found through experiment, by collecting data, or by making simple assumptions. In Section 11.2, we show how some elementary assumptions about birth and mortality could help to estimate approximate values of r and m .

Taking the assumptions and the form of the balance equation (11.2.1) together we have arrived at:

$$\frac{dN}{dt} = rN - mN = (r - m)N. \quad (11.2.2)$$

This is a differential equation: it links the derivative of $N(t)$ to the function $N(t)$. By solving the equation (i.e. identifying its solution), we are able to make a projection about how fast a population is growing.

Define the constant $k = r - m$. Then k is the **net growth rate**, of the population, so

$$\frac{dN}{dt} = kN, \quad \text{for } k = (r - m).$$

Suppose we also know that at time $t = 0$, the population size is N_0 . Then:

- The function that describes population over time is (by previous results),

$$N(t) = N_0 e^{kt} = N_0 e^{(r-m)t}. \quad (11.2.3)$$

(The result is identical to what we saw previously, but with N rather than y as the time-dependent function. We can easily check by differentiation that this function satisfies Eqn. (11.2.2).)

- Since $N(t)$ represents a population size, it has to be non-negative to have biological relevance. This is true so long as $N_0 \geq 0$.
- The initial condition $N(0) = N_0$, allows us to specify the (otherwise arbitrary) constant multiplying the exponential function.
- The population grows provided $k > 0$ which happens when $r - m > 0$ i.e. when birth rate exceeds mortality rate.
- If $k < 0$, or equivalently, $r < m$ then more people die on average than are born, so that the population shrinks and (eventually) go extinct.

►► A simple model for human population growth

The differential equation (11.2.2) and its initial condition led us to predict that a population grows or decays exponentially in time, according to Eqn. (11.2.3). We can make this prediction quantitative by estimating the values of parameters r and m . To this end, let us consider the example of a human population and make further simplifying assumptions. We measure time in years.

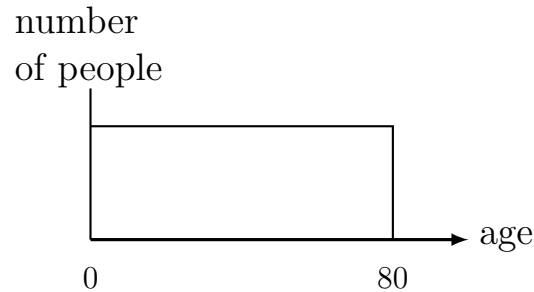

Figure 11.2: Flat age distribution assumption

We assume a uniform age distribution to determine the fraction of people who are fertile (and can give birth) or who are old (and likely to die). While slightly silly, this simplification helps estimate the desired parameters.

Assumptions.

- The age distribution of the population is “flat”, i.e. there are as many 10 year-olds as 70 year olds. Of course, this is quite inaccurate, but a good place to start since it is easy to estimate some of the quantities we need. Figure 11.2 shows such a **uniform age distribution**.
- The sex ratio is roughly 50%. This means that half of the population is female and half male.

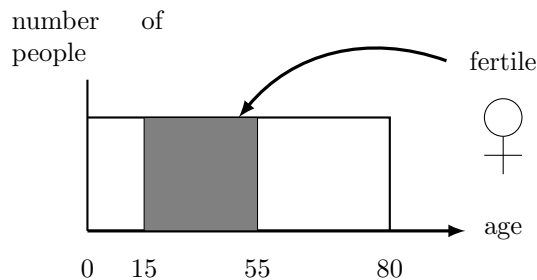

Figure 11.3: Simple assumption about fertility

We assume that only women between the ages of 15 and 55 years old are fertile and can give birth. Then, according to our uniform age distribution assumption, half of all women are between these ages and hence fertile.

- Women are fertile and can have babies only during part of their lives: we assume that the fertile years are between age 15 and age 55, as shown in Figure 11.3.
- A lifetime lasts 80 years. This means that for half of that time a given woman can contribute to the birth rate, or that $\frac{(55-15)}{80} = 50\%$ of women alive at any time are able to give birth.
- During a woman’s fertile years, we assume that on average, she has one baby every 10 years.
- We assume that deaths occur only from old age (i.e. we ignore disease, war, famine, and child mortality.)
- We assume that everyone lives precisely to age 80, and then dies instantly.

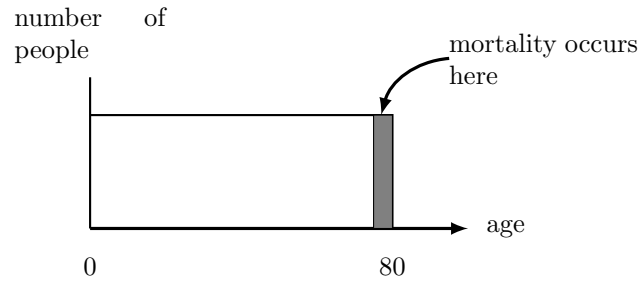

Figure 11.4: Simple assumption about mortality

We assume that the people in the age bracket 79-80 years old all die each year, and that those are the only deaths. This, too, is a silly assumption, but makes it easy to estimate mortality in the population.

Based on the above assumptions, we can estimate the birthrate parameter r as follows:

$$r = \frac{\text{number women}}{\text{population}} \cdot \frac{\text{years fertile}}{\text{years of life}} \cdot \frac{\text{number babies per woman}}{\text{number of years}}$$

Thus we compute that

$$r = \frac{1}{2} \cdot \frac{1}{2} \cdot \frac{1}{10} = 0.025 \text{ births per person per year.}$$

Concept Check-In

1. Under these assumptions, for a population size of 800, how many male 35 year-olds would you expect? Women in their 60's?
2. Is the fertility assumption reasonable? Why or why not?
3. Explain the units attached to the birthrate parameter r .

Note that this value is now a rate per person per year, averaged over the entire population (male and female, of all ages). We need such an average rate since our model of Eqn. (11.2.2) assumes that individuals “are identical”. We now have an approximate value for the average human per capita birth rate, $r \approx 0.025$ per year.

Next, using our assumptions, we estimate the mortality parameter, m . With the flat age distribution shown in Figure 11.2, there would be a fraction of $1/80$ of the population who are precisely removed by mortality every year (i.e. only those in their 80th year.) In this case, we can estimate that the per capita mortality is:

$$m = \frac{1}{80} = 0.0125 \text{ deaths per person per year.}$$

The net per capita growth rate is $k = r - m = 0.025 - 0.0125 = 0.0125$ per person per year. We often refer to the constant k as a **growth rate constant** and we also say that the population grows at the rate of 1.25% per year.

Example 11.2.1. Using the results of this section, find a prediction for the population size $N(t)$ as a function of time t .

Solution. We have found that our population satisfies the equation

$$\frac{dN}{dt} = (r - m)N = kN = 0.0125N,$$

so that

$$N(t) = N_0 e^{0.0125t}, \tag{11.2.4}$$

where N_0 is the starting population size. Figure 11.5 illustrates how this function behaves, using a starting value of $N(0) = N_0 = 7$ billion. \diamond

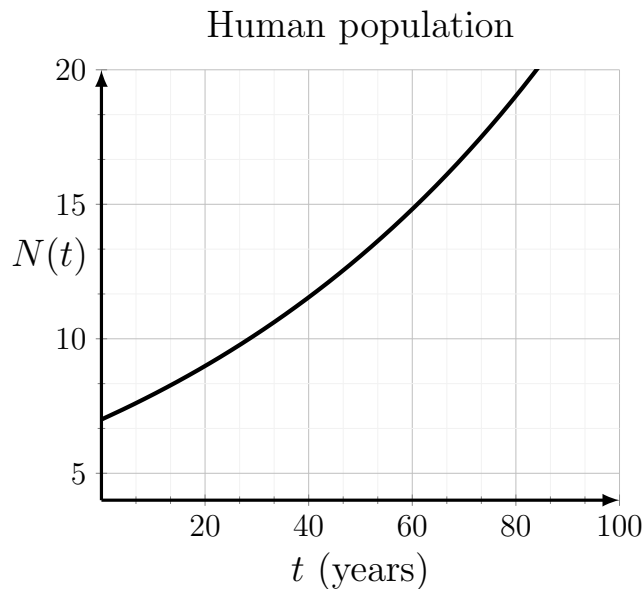

Figure 11.5: Projected world population

Projected world population (in billions) over 100 years, based on the model in Eqn. (11.2.4) and assuming that the initial population is ≈ 7 billion.

Concept Check-In

1. Based on Figure 11.5, when would we expect the human population to reach 15 billion?

Example 11.2.2 (Human population in 100 years). Given the initial condition $N(0) = 7$ billion, determine the size of the human population at $t = 100$ years predicted by the model.

Solution. At time $t = 0$, the population is $N(0) = N_0 = 7$ billion. Then in billions,

$$N(t) = 7e^{0.0125t}$$

so that when $t = 100$ we would have

$$N(100) = 7e^{0.0125 \cdot 100} = 7e^{1.25} = 7 \cdot 3.49 = 24.43.$$

Thus, with a starting population of 7 billion, there would be about 24.4 billion after 100 years based on the uncontrolled continuous growth model. \diamond

A critique. Before leaving our population model, we should remember that our projections hold only so long as some rather restrictive assumptions are made. We have made many simplifications, and ignored many features that would seriously affect these results. These include (among others),

- variations in birth and mortality rates that stem from competition for resources and,
- epidemics that take hold when crowding occurs, and
- uneven distributions of resources or space.

We have also assumed that the age distribution is uniform (flat), but that is not accurate: the population grows only by adding new infants, and this would skew the distribution even if it is initially uniform. All these factors suggest that some “healthy skepticism” should be applied to any model predictions. Predictions may cease to be valid if model assumptions are not satisfied. This caveat will lead us to think about more realistic models for population growth. Certainly, the uncontrolled exponential growth would not be sustainable in the long run. That said, such a model is a good starting point for a first description of population growth, later to be adjusted.

►► Growth and doubling

The doubling time. How long would it take a population to double, given that it is growing exponentially with growth rate k ? We seek a time t such that $N(t) = 2N_0$. Then

$$N(t) = 2N_0 \quad \text{and} \quad N(t) = N_0e^{kt},$$

implies that the population has doubled when t satisfies

$$2N_0 = N_0e^{kt}, \quad \Rightarrow \quad 2 = e^{kt} \quad \Rightarrow \quad \ln(2) = \ln(e^{kt}) = kt.$$

We solve for t . Thus, the **doubling time**, denoted τ is:

$$\tau = \frac{\ln(2)}{k}.$$

Concept Check-In

1. What are the units associated with τ ?
2. The human population hit 3 billion in 1959. How does this fit with our (imperfect) model?

Example 11.2.3 (Human population doubling time). Determine the doubling time for the human population based on the results of our approximate growth model.

Solution. We have found a growth rate of roughly $k = 0.0125$ per year for the human population. Based on this, it would take

$$\tau = \frac{\ln(2)}{0.0125} = 55.45 \text{ years}$$

for the population to double. Compare this with the graph of Fig 11.5, and note that over this time span, the population increases from 6 to 12 billion. \diamond

Note: the observant student may notice that we are simply converting back from base e to base 2 when we compute the doubling time.

We summarize an important observation:

In general, an equation of the form

$$\frac{dy}{dt} = ky$$

that represents an exponential growth has a **doubling time** of

$$\tau = \frac{\ln(2)}{k}.$$

This is shown in Figure 11.6. We have discovered that based on the uncontrolled growth model, the population doubles *every 55 years!* After 110 years, for example, there have been two doublings, or a quadrupling of the population.

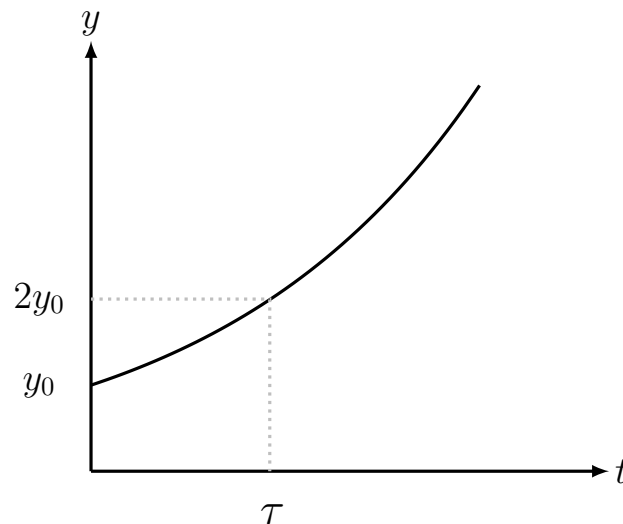

Figure 11.6: Doubling time for exponential growth.

Example 11.2.4 (A ten year doubling time). Suppose we are told that some animal population doubles every 10 years. What growth rate would lead to such a trend?

Solution. In this case, $\tau = 10$ years. Rearranging

$$\tau = \frac{\ln(2)}{k},$$

we obtain

$$k = \frac{\ln(2)}{\tau} = \frac{0.6931}{10} \approx 0.07 \text{ per year.}$$

Thus, a growth rate of 7% leads to doubling roughly every 10 years. \diamond

11.3 ▲ Radioactive decay

A radioactive material consists of atoms that undergo a spontaneous change. Every so often, some radioactive atom emits a particle, and decays into an inert form. We call this a process of **radioactive decay**. For any one atom, it is impossible to predict when this event would occur exactly, but based on the behaviour of a large number of atoms decaying spontaneously, we can assign a **probability** k of decay per unit time.

In this section, we use the same kind of book-keeping (keeping track of the number of radioactive atoms remaining) as in the population growth example, to arrive at a differential equation that describes the process. Once we have the equation, we determine its solution and make a long-term prediction about the amount of radioactivity remaining at a future time.

►► Deriving the model

We start by letting $N(t)$ be the number of radioactive atoms at time t . Generally, we would know $N(0)$, the number present initially. Our goal is to make simple assumptions about the process of decay that allows us to arrive at a mathematical model to predict values of $N(t)$ at any later time $t > 0$.

Assumptions.

- (1) The process of radioactive decay is random, but on average, the probability of decay for a given radioactive atom is k per unit time where $k > 0$ is some constant.
- (2) During each (small) time interval of length $\Delta t = h$, a radioactive atom has probability kh of decaying. This is merely a restatement of (1).

Concept Check-In

1. Suppose a given atom has a 1% chance of decay per 24 hours. What is this atom's probability of decay per week? Per hour?

Suppose that at some time t , there are $N(t)$ radioactive atoms. Then, according to our assumptions, during the time period $t \leq t \leq t + h$, on average $khN(t)$ atoms would decay. How many are there at time $t + h$? We can write the following balance-equation:

$$\left[\begin{array}{c} \text{Amount left} \\ \text{at time} \\ t + h \end{array} \right] = \left[\begin{array}{c} \text{Amount present} \\ \text{at time} \\ t \end{array} \right] - \left[\begin{array}{c} \text{Amount decayed} \\ \text{during time interval} \\ t \leq t \leq t + h \end{array} \right]$$

or, restated:

$$N(t + h) = N(t) - khN(t). \quad (11.3.1)$$

Here we have assumed that h is a small time period. Rearranging Eqn. (11.3.1) leads to

$$\frac{N(t + h) - N(t)}{h} = -kN(t).$$

Considering the left hand side of this equation, we let h get smaller and smaller ($h \rightarrow 0$) and recall that

$$\lim_{h \rightarrow 0} \frac{N(t + h) - N(t)}{h} = \frac{dN}{dt} = N'(t)$$

where we have used the notation for a derivative of N with respect to t . We have thus shown that a description of the population of radioactive atoms reduces to

$$\frac{dN}{dt} = -kN. \quad (11.3.2)$$

We have, once more, arrived at a differential equation that provides a link between a function of time $N(t)$ and its own rate of change dN/dt . Indeed, this equation specifies that dN/dt is proportional to N , but with a negative constant of proportionality which implies decay.

Above we formulated the entire model in terms of the **number** of radioactive atoms. However, as shown below, the same equation holds regardless of the system of units used to measure the amount of radioactivity

Example 11.3.1. Define the number of moles of radioactive material by $y(t) = N(t)/A$ where A is **Avogadro's number** (the number of molecules in 1 mole: $\approx 6.022 \times 10^{23}$ - a dimensionless quantity, i.e. just a number with no associated units). Determine the differential equation satisfied by $y(t)$.

Solution. We write $y(t) = N(t)/A$ in the form $N(t) = Ay(t)$ and substitute this expression for $N(t)$ in Eqn. (11.3.2). We use the fact that A is a constant to simplify the derivative. Then

$$\frac{dN}{dt} = -kN \quad \Rightarrow \quad \frac{A dy(t)}{dt} = -k(Ay(t)) \quad \Rightarrow \quad A \frac{dy(t)}{dt} = A(-ky(t))$$

cancelling the constant A from both sides of the equations leads to

$$\frac{dy(t)}{dt} = -ky(t), \quad \text{or simply} \quad \frac{dy}{dt} = -ky. \quad (11.3.3)$$

Thus $y(t)$ satisfies the same kind of differential equation (with the same negative proportionality constant) between the derivative and the original function. We will refer to (11.3.3) as the **decay equation**. \diamond

►► Solution to the decay equation (11.3.3)

Suppose that initially, there was an amount y_0 . Then, together, the differential equation and initial condition are

$$\frac{dy}{dt} = -ky, \quad y(0) = y_0. \quad (11.3.4)$$

We often refer to this pairing between a differential equation and an initial condition as an **initial value problem**. Next, we show that an exponential function is an appropriate solution to this problem

Example 11.3.2 (Checking a solution). Show that the function

$$y(t) = y_0 e^{-kt}. \quad (11.3.5)$$

is a solution to initial value problem (11.3.4).

Solution. We compute the derivative of the candidate function (11.3.5), and rearrange, obtaining

$$\frac{dy(t)}{dt} = \frac{d}{dt}[y_0 e^{-kt}] = y_0 \frac{de^{-kt}}{dt} = -ky_0 e^{-kt} = -ky(t).$$

This verifies that for the derivative of the function is $-k$ times the original function, so satisfies the DE in (11.3.4). We can also check that the initial condition is satisfied:

$$y(0) = y_0 e^{-k \cdot 0} = y_0 e^0 = y_0 \cdot 1 = y_0.$$

Hence, Eqn. (11.3.5) is the solution to the initial value problem for radioactive decay. For $k > 0$ a constant, this is a decreasing function of time that we refer to as **exponential decay**. \diamond

►► The half life

Given a process of exponential decay, how long would it take for half of the original amount to remain? Let us recall that the “original amount” (at time $t = 0$) is y_0 . Then we are looking for the time t such that $y_0/2$ remains. We must solve for t in

$$y(t) = \frac{y_0}{2}.$$

We refer to the value of t that satisfies this as the **half life**.

Example 11.3.3 (Half life). Determine the half life in the exponential decay described by Eqn. (11.3.5).

Solution. We compute:

$$\frac{y_0}{2} = y_0 e^{-kt} \Rightarrow \frac{1}{2} = e^{-kt}.$$

Now taking reciprocals:

$$2 = \frac{1}{e^{-kt}} = e^{kt}.$$

Thus we find the same result as in our calculation for doubling times, namely,

$$\ln(2) = \ln(e^{kt}) = kt,$$

so that the half life is

$$\tau = \frac{\ln(2)}{k}.$$

This is shown in Figure 11.7.

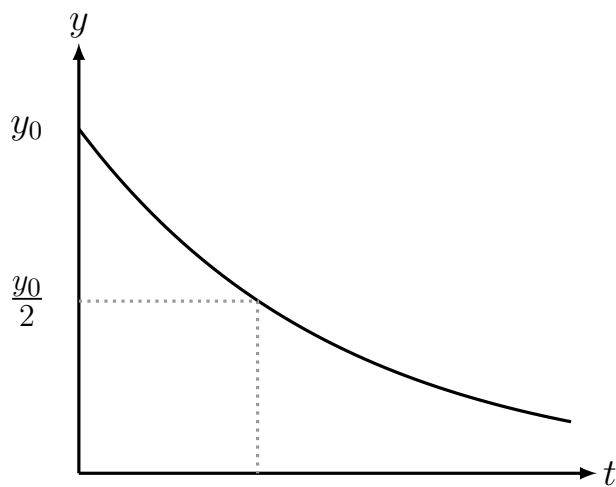

[-1in]

Figure 11.7: Half-life in an exponentially decreasing process.

Example 11.3.4 (Chernobyl: April 1986). In 1986 the Chernobyl nuclear power plant exploded, and scattered radioactive material over Europe. The radioactive element iodine-131 (I^{131}) has half-life of 8 days whereas cesium-137 (Cs^{137}) has half life of 30 years. Use the model for radioactive decay to predict how much of this material would remain over time.

Solution. We first determine the decay constants for each of these two elements, by noting that

$$k = \frac{\ln(2)}{\tau},$$

and recalling that $\ln(2) \approx 0.693$. Then for I^{131} we have

$$k = \frac{\ln(2)}{\tau} = \frac{\ln(2)}{8} = 0.0866 \text{ per day.}$$

Then the amount of I^{131} left at time t (in days) would be

$$y_I(t) = y_0 e^{-0.0866t}.$$

For Cs^{137}

$$k = \frac{\ln(2)}{30} = 0.023 \text{ per year.}$$

so that for T in years,

$$y_C(T) = y_0 e^{-0.023T}.$$

Note: we have used T rather than t to emphasize that units are different in the two calculations done in this example.

Example 11.3.5 (Decay to 0.1% of the initial level). How long it would take for I^{131} to decay to 0.1% of its initial level? Assume that the initial level occurred just after the explosion at Chernobyl.

Solution. We must calculate the time t such that $y_I = 0.001y_0$:

$$0.001y_0 = y_0 e^{-0.0866t} \Rightarrow 0.001 = e^{-0.0866t} \Rightarrow \ln(0.001) = -0.0866t.$$

Therefore,

$$t = \frac{\ln(0.001)}{-0.0866} = \frac{-6.9}{-0.0866} = 79.7 \text{ days.}$$

Thus it would take about 80 days for the level of Iodine-131 to decay to 0.1% of its initial level. \diamond

Concept Check-In

1. Repeat the calculation in Example 11.3.5 for Cesium.
2. Convert the Cesium decay time units to days and repeat the calculation of Example 11.3.4 with the new time units.
3. If the decay rate of a substance is 10% per day, what is its half-life?

11.4 ▲ Summary

1. A differential equation is a statement linking the rate of change of some state variable with current values of that variable. An example is the simplest population growth model: if $N(t)$ is population size at time t :

$$\frac{dN}{dt} = kN.$$

2. A solution to a differential equation is a function that satisfies the equation. For instance, the function $N(t) = Ce^{kt}$ (for any constant C) is a solution to the unlimited population growth model (we check this by the appropriate differentiation). Graphs of such solutions (e.g. N versus t) are called solution curves.
3. To select a specific solution, more information (an initial condition) is needed. Given this information, e.g. $N(0) = N_0$, we can fully characterize the desired solution.
4. The **decay equation** is one representative of the same class of problems, and has an exponentially decaying solution.

$$\frac{dy}{dt} = -ky, \quad y(0) = y_0 \quad \Rightarrow \quad \text{Solution: } y(t) = y_0e^{-kt}. \quad (11.4.1)$$

5. So far, we have seen simple differential equations with simple (exponential) functions for their solutions. In general, it may be quite challenging to make the connection between the differential equation (stemming from some application or model) with the solution (which we want in order to understand and predict the behaviour of the system.)

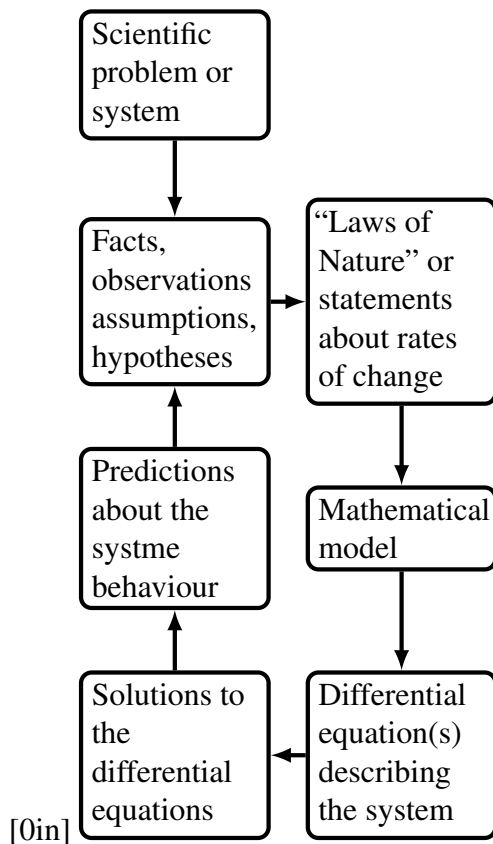

Figure 11.8: A “flow chart” showing how differential equations originate from scientific problems.

In this chapter, we saw examples in which a natural phenomenon (population growth, radioactive decay, cell growth) motivated a mathematical model that led to a differential equation. In both cases,

that equation was derived by making a statement that tracked the amount or number or mass of a system over time. Numerous simplifications were made to derive each differential equation. For example, we assumed that the birth and mortality rates stay fixed even as the population grows to huge sizes.

With regard to a larger context.

- Our purpose was to illustrate how a simple model is created, and what such models can predict.
- In general, differential equation models are often based on physical laws (“ $F = ma$ ”) or conservation statements (“rate in minus rate out equals net rate of change”, or “total energy = constant”).
- In biology, where the laws governing biochemical events are less formal, the models are often based on some mix of speculation and reasonable assumptions.
- In Figure 11.8 we illustrate how the scientific method leads to a cycle between the mathematical models and their test and validation using observations about the natural world.

Quick Concept Check

1. Identify each of the following with either exponential growth or exponential decay:

(a) $y = 20e^{3t}$;

(b) $y = 5e^{-3t}$;

(c) $\frac{dy}{dt} = 3t$;

(d) $\frac{dy}{dx} = -5x$.

2. Determine the doubling time of the exponential growth function $N(t) = 500e^{2t}$.

3. Determine the half life of the of the exponential decay function $N(t) = 500e^{-2t}$.

4. Consider the following figure depicting exponential growth:

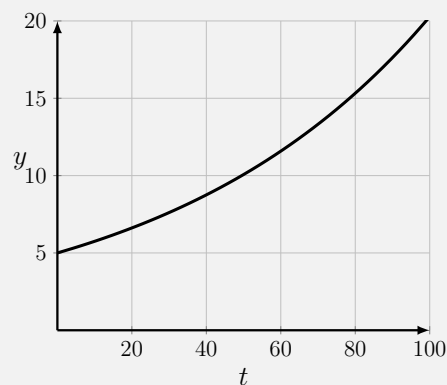

What is the doubling time of this function?

Chapter 12

**(FLAVOURS A, B) SOLVING
DIFFERENTIAL EQUATIONS**

In Chapter 11, we introduced differential equations to keep track of continuous changes in the growth of a population or the decay of radioactivity. We encountered a differential equation that tracks changes in cell mass due to nutrient absorption and consumption. Finally, we learned that the solutions to a differential equation is a function. In applications studied, that function can be interpreted as predictions of the behaviour of the system or process over time.

In this chapter, we further develop some of these ideas. We explore several techniques for finding and verifying that a given function is a solution to a differential equation. We then examine a simple class of differential equations that have many applications to processes of production and decay, and find their solutions. Finally, we show how an approximation method provides for numerical solutions of such problems.

12.1 ▲ Verifying that a function is a solution

In this section we concentrate on analytic solutions to a differential equation. By **analytic solution**, we mean a “formula” such as $y = f(x)$ that satisfies the given differential equation. We saw in Chapter 11 that we can check whether a function satisfies a differential equation (e.g., Example 11.3.2) by simple differentiation. In this section, we further demonstrate this process.

Example 12.1.1. Show that the function $y(t) = (2t + 1)^{1/2}$ is a solution to the differential equation and initial condition

$$\frac{dy}{dt} = \frac{1}{y}, \quad y(0) = 1.$$

Solution. First, we check the derivative, obtaining

$$\begin{aligned} \frac{dy(t)}{dt} &= \frac{d(2t + 1)^{1/2}}{dt} = \frac{1}{2}(2t + 1)^{-1/2} \cdot 2 \\ &= (2t + 1)^{-1/2} = \frac{1}{(2t + 1)^{1/2}} = \frac{1}{y}. \end{aligned}$$

LHS	RHS
$\frac{dy}{dt}$	$1 - y$
$\frac{d[y_0e^{-t}]}{dt}$	$1 - y_0e^{-t}$
$-y_0e^{-t}$	✓

Table 12.1: The function $y(t) = y_0e^{-t}$ is **not** a solution to the differential equation (12.1.1). Plugging the function into each side of the DE and simplifying (down the rows) leads to expressions that do not match.

LHS	RHS
$\frac{dy}{dt}$	$1 - y$
$\frac{d}{dt}[1 - (1 - y_0)e^{-t}]$	$1 - [1 - (1 - y_0)e^{-t}]$
$-(1 - y_0)\frac{de^{-t}}{dt}$	$(1 - y_0)e^{-t}$
$(1 - y_0)e^{-t}$	✓

Table 12.2: (b) The function $y(t) = 1 - (1 - y_0)e^{-t}$ is a solution to the differential equation (12.1.1). The expressions we get by evaluating each side of the differential equation do match.

Hence, the function satisfies the differential equation. We must also verify the initial condition. We find that $y(0) = (2 \cdot 0 + 1)^{1/2} = 1^{1/2} = 1$. Thus the initial condition is also satisfied, and $y(t)$ is indeed a solution. \diamond

Example 12.1.2. Consider the differential equation and initial condition

$$\frac{dy}{dt} = 1 - y, \quad y(0) = y_0. \quad (12.1.1)$$

- a) Show that the function $y(t) = y_0e^{-t}$ is **not** a solution to this differential equation.
 b) Show that the function $y(t) = 1 - (1 - y_0)e^{-t}$ is a solution.

Solution.

- a) To check whether $y(t) = y_0e^{-t}$ is a solution to the differential equation (12.1.1), we substitute the function into each side (“left hand side”, LHS; “right hand side”, RHS) of the equation. We show the results in the columns of Table 12.1. After some steps in the simplification, we see that the two sides do not match, and conclude that the function is not a solution, as it fails to satisfy the equation
- b) Similarly, we check the second function. The calculations are shown in columns of Table 12.2. We find that $\text{RHS}=\text{LHS}$, so the differential equation is satisfied. Finally, let us show that the initial condition $y(0) = y_0$ is also satisfied. Plugging in $t = 0$ we have

$$y(0) = 1 - (1 - y_0)e^0 = 1 - (1 - y_0) \cdot 1 = 1 - (1 - y_0) = y_0.$$

Thus, both differential equation and initial condition are satisfied.

◇

Example 12.1.3 (Height of water draining out of a cylindrical container). A cylindrical container with cross-sectional area A has a small hole of area a at its base, through which water leaks out. It can be shown that height of water $h(t)$ in the container satisfies the differential equation

$$\frac{dh}{dt} = -k\sqrt{h}, \quad (12.1.2)$$

(where k is a constant that depends on the size and shape of the cylinder and its hole: $k = \frac{a}{A}\sqrt{2g} > 0$ and g is acceleration due to gravity.) Show that the function

$$h(t) = \left(\sqrt{h_0} - k\frac{t}{2}\right)^2 \quad (12.1.3)$$

Concept Check-In

1. Draw a diagram of the system described in Example 12.1.3.
2. What set of units would be reasonable for each of the parameters in Example 12.1.3.
3. Create a table to organize the calculations for this example, similar to Tables 12.1 and 12.2.

is a solution to the differential equation (12.1.2) and initial condition $h(0) = h_0$.

Solution. We first easily verify that the initial condition is satisfied. Substitute $t = 0$ into the function (12.1.3). Then we find $h(0) = h_0$, verifying the initial conditions.

To show that the differential equation (12.1.2) is satisfied, we differentiate the function in Eqn. (12.1.3):

$$\begin{aligned} \frac{dh(t)}{dt} &= \frac{d}{dt} \left(\sqrt{h_0} - k\frac{t}{2}\right)^2 = 2\left(\sqrt{h_0} - k\frac{t}{2}\right) \cdot \left(\frac{-k}{2}\right) \\ &= -k\left(\sqrt{h_0} - k\frac{t}{2}\right) = -k\sqrt{h(t)}. \end{aligned}$$

Here we have used the power law and the chain rule, remembering that h_0, k are constants. Now we notice that, using Eqn. (12.1.3), the expression for $\sqrt{h(t)}$ exactly matches what we have computed for dh/dt . Thus, we have shown that the function in Eqn. (12.1.3) satisfies both the initial condition and the differential equation. ◇

As shown in Examples 12.1.1- 12.1.3, if we are told that a function is a solution to a differential equation, we can check the assertion and verify that it is correct or incorrect. A much more difficult task is to find the solution of a new differential equation from first principles.

In some cases, **integration**, learned in second semester calculus, can be used. In others, some transformation that changes the problem to a more familiar one is helpful - an example of this type is presented in Section 12.2. In many cases, particularly those of so-called non-linear differential equations, great expertise and familiarity with advanced mathematical methods are required to find the solution to such problems in an analytic form, i.e. as an explicit formula. In such cases, approximation and numerical methods are helpful.

12.2 ▸ Equations of the form $y'(t) = a - by$

In this section we introduce an important class of differential equations that have many applications in physics, chemistry, biology, and other applications. All share a similar structure, namely all are of the form

$$\frac{dy}{dt} = a - by, \quad y(0) = y_0. \quad (12.2.1)$$

First, we show how a solution to such equation can be found. Then, we examine a number of applications.

►► Special solutions: steady states

We first ask about “special solutions” to the differential equation (12.2.1) in which there is no change over time. That is, we ask whether there are values of y for which $dy/dt = 0$.

📺 An explanation of the way we find solutions to equations of the form $\frac{dy}{dt} = a - by$, with $y(0) = y_0$.

From (12.2.1), we find that such solutions would satisfy

$$\frac{dy}{dt} = 0 \quad \Rightarrow \quad a - by = 0 \quad \Rightarrow \quad y = \frac{a}{b}.$$

In other words, if we were to start with the initial value $y(0) = a/b$, then that value would not

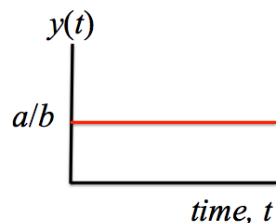

Figure 12.1: $y = a/b$ is a constant solution to the differential equation in (12.2.1). We call this type of solution a **steady state**.

change, since it satisfies $dy/dt = 0$, so that the solution at all future times would be $y(t) = a/b$. (Of course, this is a perfectly good function; it is simply a function that is always constant.)

We refer to such constant solutions as **Steady States**.

►► Other solutions: away from steady state

What happens if we start with a value of y that is not exactly at the “special” steady state? Let us rewrite the DE in a more suggestive form,

$$\frac{dy}{dt} = a - by \quad \Rightarrow \quad \frac{dy}{dt} = -b \left(y - \frac{a}{b} \right),$$

(having factored out $-b$). The advantage is that we recognize the expression $(y - \frac{a}{b})$ as the difference, or **deviation** of y away from its steady state value. (That deviation could be either positive or negative, depending on whether y is larger or smaller than a/b .) We ask whether this deviation gets larger or smaller as time goes by, i.e., whether y gets further away or closer to its steady state value a/b .

Define $z(t)$ as that deviation, that is

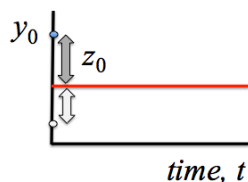

Figure 12.2: We define $z(t)$ as the deviation of y from its steady state value. Here we show two typical initial values of z , where $z_0 = y_0 - \frac{a}{b}$.

$$z(t) = y(t) - \frac{a}{b},$$

Then, since a, b are constants, we recognize that

$$\frac{dz}{dt} = \frac{dy}{dt}.$$

Second, the initial value of z follows simply from the initial value of y :

$$z(0) = y(0) - \frac{a}{b} = y_0 - \frac{a}{b}.$$

Now we can **transform** the equation (12.2.1) into a new differential equation for the variable z by using these two facts. We can replace the y derivative by the z derivative, and also, using Eqn. (12.2.1), find that

$$\frac{dz}{dt} = \frac{dy}{dt} = -b \left(y - \frac{a}{b} \right) = -bz.$$

Hence, we have transformed the original DE and IC into the new problem

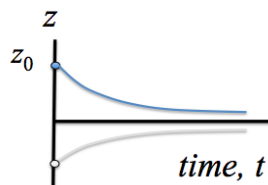

Figure 12.3: The deviation away from steady state (blue, grey curves) is $z(t) = y(t) - a/b$. We can solve the differential equation for $z(t)$ because it is a simple exponential decay equation. Here we show two typical solutions for z .

$$\frac{dz}{dt} = -bz, \quad z(0) = z_0, \quad \left[\text{where } z_0 = y_0 - \frac{a}{b} \right].$$

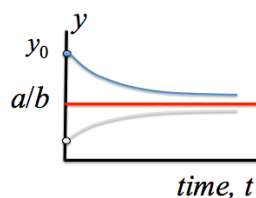

Figure 12.4: Finally, we can determine the solution $y(t)$.

But this is the familiar decay initial value problem that we have already solved before. So

$$z(t) = z_0 e^{-bt}.$$

We have arrived at the conclusion that the deviation from steady state **decays exponentially** with time, provided that $b > 0$. Hence, we already know that y should get closer to the constant value a/b as time goes by!

We can do even better than this, by transforming the solution we found for $z(t)$ into an expression for $y(t)$. To do so, use the definition once more, setting

 Adjust the sliders to see how the parameters a and b and the initial value y_0 affect the shape of the function $y(t)$ in the formula (12.2.2).

$$z(t) = z_0 e^{-bt} \quad \Rightarrow \quad y(t) - \frac{a}{b} = \left(y_0 - \frac{a}{b}\right) e^{-bt}.$$

Solving for $y(t)$ then leads to

$$y(t) = \frac{a}{b} + \left(y_0 - \frac{a}{b}\right) e^{-bt}. \quad (12.2.2)$$

Example 12.2.1 ($a = b = 1$). Suppose we are given the differential equation and initial condition

$$\frac{dy}{dt} = 1 - y, \quad y(0) = y_0. \quad (12.2.3)$$

Determine the solution to this differential equation.

Solution.

Concept Check-In

1. Find the steady state of Eqn. (12.2.3).
2. From Figure 12.5, determine what were the four different initial conditions used.
3. Rewrite these four initial conditions as the initial deviations away from steady state, that is, give the initial values, z_0 of the deviation.

By substituting $a = 1, b = 1$ in the solution found above, we observe that

$$y(t) = 1 - (1 - y_0)e^{-t}.$$

Representative curves in this **family of solutions** are shown in Figure 12.5 for various initial values y_0 . ◇

We now apply the methods to a number of examples.

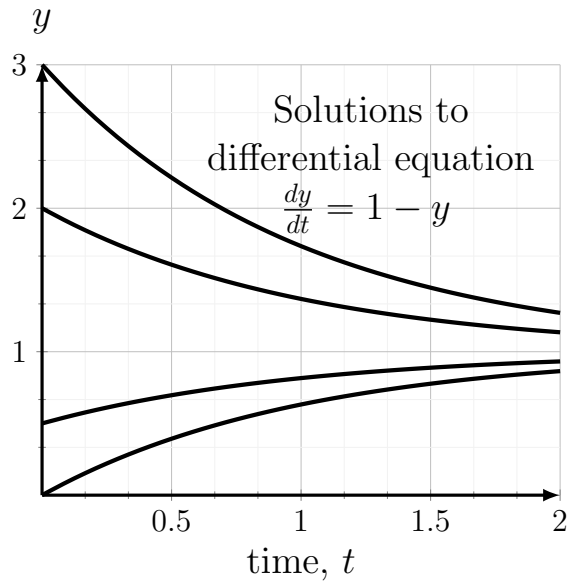

Figure 12.5: Solutions to Eqn. (12.2.3) are functions that approach $y = 1$.

►► Newton's law of cooling

Note: Newton's law of cooling is another nice example of the modelling we can do using differential equations. For Math 100, you don't have to memorize the specifics of this law – it's shown here only as an example.

Consider an object at temperature $T(t)$ in an environment whose ambient temperature is E . Depending on whether the object is cooler or warmer than the environment, it heats up or cools down. From common experience we know that, after a long time, the temperature of the object equilibrates with its environment.

Isaac Newton formulated a hypothesis to describe the rate of change of temperature of an object. He assumed that

The rate of change of temperature T of an object is proportional to the difference between its temperature and the ambient temperature, E .

To rephrase this statement mathematically, we write

$$\frac{dT}{dt} \text{ is proportional to } (T(t) - E).$$

This implies that the derivative dT/dt is some constant multiple of the term $(T(t) - E)$. However, the sign of that constant requires some discussion. Denote the constant of proportionality by α temporarily, and suppose $\alpha \geq 0$. Let us check whether the differential equation

$$\frac{dT}{dt} = \alpha(T(t) - E),$$

makes physical sense.

Concept Check-In

1. What can we say about the units of T and E ?

Suppose the object is warmer than its environment ($T(t) > E$). Then $T(t) - E > 0$ and $\alpha \geq 0$ implies that $dT/dt > 0$ which says that the temperature of the object should get *warmer*! But this does not agree with our everyday experience: a hot cup of coffee cools off in a chilly room. Hence $\alpha \geq 0$ cannot be correct. Based on this, we conclude that Newton's Law of Cooling, written in the form of a differential equation, should read:

$$\frac{dT}{dt} = k(E - T(t)), \quad \text{where } k > 0. \quad (12.2.4)$$

Note: the sign of the term in braces has been switched.

Typically, given the temperature at some initial time $T(0) = T_0$, we want to predict $T(t)$ for later time.

Example 12.2.2. Consider the temperature $T(t)$ as a function of time. Solve the differential equation for Newton's law of cooling

$$\frac{dT}{dt} = k(E - T),$$

together with the initial condition $T(0) = T_0$.

Solution. As before, we transform the variable to reduce the differential equation to one that we know how to solve. This time, we select the new variable to be $z(t) = E - T(t)$. Then, by steps similar to previous examples, we find that

$$\frac{dz(t)}{dt} = -kz.$$

We also rewrite the initial condition in terms of z , leading to $z(0) = E - T(0) = E - T_0$. After carrying out **Steps 1-3** as before, we find the solution for $T(t)$,

$$T(t) = E + (T_0 - E)e^{-kt}. \quad (12.2.5)$$

Concept Check-In

1. Fill in the details for Example 12.2.2.
2. In Figure 12.6, what are the five different initial temperatures, T_0 corresponding to each solution curve?
3. In Figure 12.6, how many curves represent a heating object and how many a cooling object?

In Figure 12.6 we show a family of curves of the form of Eqn. (12.2.5) for five different initial temperature values (we have set $E = 10$ and $k = 0.2$ for all these curves). \diamond

Next, we interpret the behaviour of these solutions.

Example 12.2.3. Explain (in words) what the form of the solution in Eqn. (12.2.5) of Newton's law of cooling implies about the temperature of an object as it warms or cools.

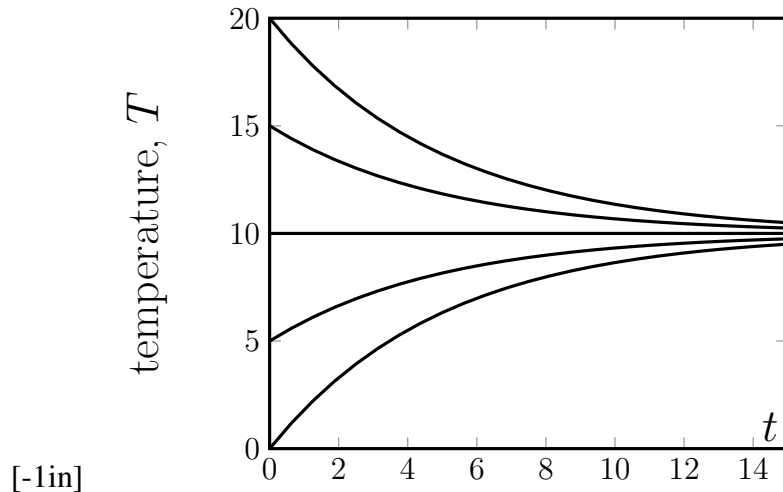

Figure 12.6: Temperature versus time, $T(t)$, for a cooling object.

Solution. We make the following remarks

- It is straightforward to verify that the initial temperature is $T(0) = T_0$ (substitute $t = 0$ into the solution of Eqn. (12.2.5)). Now examine the time dependence. Only one term, e^{-kt} depends on time. Since $k > 0$, this is an exponentially decaying function, whose magnitude shrinks with time. The whole term that it multiplies, $(T_0 - E)e^{-kt}$, continually shrinks. Hence,

$$T(t) = E + (T_0 - E)e^{-kt} \Rightarrow \text{as } t \rightarrow \infty, \quad e^{-kt} \rightarrow 0, \\ \text{so } T(t) \rightarrow E.$$

Thus the temperature of the object always approaches the ambient temperature. This is evident in the solution curves shown in Figure 12.6.

- We also observe that the direction of approach (decreasing or increasing) depends on the sign of the constant $(T_0 - E)$. If $T_0 > E$, the temperature approaches E from above, whereas if $T_0 < E$, the temperature approaches E from below.
- In the specific case that $T_0 = E$, there is no change at all. $T = E$ satisfies $dT/dt = 0$, and corresponds to a **steady state** of the differential equation, as previously defined.

Steady states are studied in more detail in Chapter 13.

Concept Check-In

1. Consider three cups of coffee left in a 20°C room. If one is iced, another is piping hot, and the third is room temperature, which cup will not change temperature? Which, thus, represents a steady state?
2. Convert the temperatures in Example 12.2.4 to Fahrenheit and repeat.

►► Using Newton's law of cooling to solve a mystery

Now that we have a detailed solution to the differential equation representing Newton's law of cooling, we can apply it to making exact determinations of temperature over time, or of time at which a certain temperature was attained. The following example illustrates an application of this idea.

Example 12.2.4 (Murder mystery). It is a dark clear night. The air temperature is 10° C. A body is discovered at midnight. Its temperature is 27° C. One hour later, the body has cooled to 24° C. Use Newton's law of cooling to determine the time of death.

Details of the calculations for Example 12.2.4.

Solution. We assume that body-temperature just before death was 37° C (normal human body temperature). Let $t = 0$ be the time of death. Then the initial temperature is $T(0) = T_0 = 37^\circ$ C. We want to find the time elapsed until the body was found, i.e. time t at which the temperature of the body had cooled down to 27° C. We assume that the ambient temperature, $E = 10$, was constant. From Newton's law of cooling, the body temperature satisfies

$$\frac{dT}{dt} = k(10 - T).$$

From previous work and Eqn. (12.2.5), the solution to this DE is

$$T(t) = 10 + (37 - 10)e^{-kt}.$$

We do not know the value of the constant k , but we have enough information to find it. First, at discovery, the body's temperature was 27° . Hence at time t

$$27 = 10 + 27e^{-kt} \quad \Rightarrow \quad 17 = 27e^{-kt}.$$

Also at $t + 1$ (one hour after discovery), the temperature was 24° C, so

$$T(t + 1) = 10 + (37 - 10)e^{-k(t+1)} = 24, \quad \Rightarrow \quad 24 = 10 + 27e^{-k(t+1)}.$$

Thus,

$$14 = 27e^{-k(t+1)}.$$

We have two equations for the two unknowns t and k . To solve for k , take a ratio of the sides of the equations. Then

$$\frac{14}{17} = \frac{27e^{-k(t+1)}}{27e^{-kt}} = e^{-k} \quad \Rightarrow \quad -k = \ln\left(\frac{14}{17}\right) = -0.194.$$

This is the constant that describes the rate of cooling of the body.

To find the time of death, t , use

$$17 = 27e^{-kt} \quad \Rightarrow \quad -kt = \ln\left(\frac{17}{27}\right) = -0.4626$$

finally, solving for t , we get

Concept Check-In

1. Give the concluding sentence for Example 12.2.4. Be sure to include an actual time of death, given that the body was discovered at midnight.
2. Use a plotting program to graph $T(t)$ for Example 12.2.4.
3. Use your plot to estimate how long it took for the body to cool off to 33°C .

$$t = \frac{0.4626}{k} = \frac{0.4626}{0.194} = 2.384 \text{ hours.}$$

◇

►► Related applications and further examples

Having gained familiarity with specific examples, we now return to the general case and summarize the results.

The differential equation and initial condition

$$\frac{dy}{dt} = a - by, \quad y(0) = y_0 \quad (12.2.6)$$

has the solution

$$y(t) = \frac{a}{b} - \left(\frac{a}{b} - y_0\right) e^{-bt}. \quad (12.2.7)$$

Suppose that $a, b > 0$ in Eqn. (12.2.6). Then we can summarize the behaviour of the solutions (12.2.7) as follows:

- The time dependence of Eqn. (12.2.7) is contained in the term e^{-bt} , which (for $b > 0$) is exponentially decreasing. As time increases, $t \rightarrow \infty$, the exponential term becomes negligibly small, so $y \rightarrow a/b$.
- If initially $y(0) = y_0 > a/b$, then $y(t)$ approaches a/b from above, whereas if $y_0 < a/b$, it approaches a/b from below.
- If initially $y_0 = a/b$, there is no change at all ($dy/dt = 0$). Thus $y = a/b$ is a **steady state** of the DE in Eqn. (12.2.6).

Recognizing such general structure means that we can avoid repeating similar calculations from scratch in related examples. Newton's law of cooling is one representative of the class of differential equations of the form Eqn. (12.2.6). If we set $a = kE, b = k$ and $T = y$ in Eqn. (12.2.6), we get back to Eqn. (12.2.4). As expected from the general case, T approaches $a/b = E$, the ambient temperature, which corresponds to a steady state of NLC.

Next, we describe other examples that share this structure, and hence similar dynamic behaviour.

Friction and terminal velocity A falling object accelerates under the force of gravity, but friction slows down this acceleration.

Note

Eqn. (12.2.8) comes from a simple force balance:

$$ma = F_{gravity} - F_{drag},$$

and from the assumption that $F_{drag} = \mu v$, where $\mu > 0$ is the “drag coefficient”. Dividing both sides by m and replacing a by dv/dt leads to this equation, with $k = \mu/m$.

The differential equation satisfied by the velocity $v(t)$ of the falling object with friction is

$$\frac{dv}{dt} = g - kv \quad (12.2.8)$$

where $g > 0$ is acceleration due to gravity and $k > 0$ is a constant representing the effect of air resistance. Usually, a frictional force is assumed to be proportional to the velocity of the object, and to act in a direction that slows it down. (This accounts for the negative sign in Eqn. (12.2.8).) Parachutes operate on the principle of enhancing that frictional force to damp out the acceleration of a skydiver. Hence, Eqn. (12.2.8) is often called the **skydiver equation**.

Example 12.2.5. Use the general results for Eqn. (12.2.6) to write down the solution to the differential equation (12.2.8) for the velocity of a skydiver given the initial condition $v(0) = v_0$. Interpret your results in a simple description of what happens over time.

Concept Check-In

1. Assign appropriate units to each of the parameters in Example 12.2.5.
2. When a sky-diver steps into the void, her initial vertical velocity is zero. Write down her velocity $v(t)$ based on results of Example 12.2.5 .

Solution. Eqn. (12.2.8) is of the same form as Eqn. (12.2.6), and has the same type of solutions. We merely have to adjust the notation, by identifying

$$v(t) \rightarrow y(t), \quad g \rightarrow a, \quad k \rightarrow b, \quad v_0 \rightarrow y_0.$$

Hence, without further calculation, we can conclude that the solution of (12.2.8) together with its initial condition is:

$$v(t) = \frac{g}{k} - \left(\frac{g}{k} - v_0 \right) e^{-kt}. \quad (12.2.9)$$

The velocity is initially v_0 , and eventually approaches g/k which is the **steady state** or **terminal velocity** for the object. Depending on the initial speed, the object either slows down (if $v_0 > g/k$) or speed up (if $v_0 < g/k$) as it approaches the terminal velocity. \diamond

Chemical production and decay. A chemical reaction inside a fixed reaction volume produces a substance at a constant rate K_{in} . A second reaction results in decay of that substance at a rate proportional to its concentration. Let $c(t)$ denote the time-dependent concentration of the substance, and assume that time is measured in units of hours. Then, writing down a balance equation leads to a differential equation of the form

$$\frac{dc}{dt} = K_{in} - \gamma c. \quad (12.2.10)$$

Here, the first term is the rate of production and the second term is the rate of decay. The net rate of change of the chemical concentration is then the difference of the two. The constants $K_{\text{in}} > 0, \gamma > 0$ represent the rate of production and decay - recall that the *units of each term in any equation have to match*. For example, if the concentration c is measured in units of milli-Molar (mM), then dc/dt has units of mM/hr, and hence K_{in} must have units of mM/h and γ must have units of 1/hr.

Example 12.2.6. Write down the solution to the DE (12.2.10) given the initial condition $c(0) = c_0$. Determine the steady state chemical concentration.

Solution. Translating notation from the general case to this example,

$$c(t) \rightarrow y(t), \quad K_{\text{in}} \rightarrow a, \quad \gamma \rightarrow b.$$

Then we can immediately write down the solution:

$$c(t) = \frac{K_{\text{in}}}{\gamma} - \left(\frac{K_{\text{in}}}{\gamma} - c_0 \right) e^{-\gamma t}. \quad (12.2.11)$$

Regardless of its initial condition, the chemical concentration will approach a steady state concentration is $c = K_{\text{in}}/\gamma$. \diamond

In this section we have seen that the behaviour found in the general case of the differential equation (12.2.1), can be reinterpreted in each specific situation of interest. This points to one powerful aspect of mathematics, namely the ability to use results in abstract general cases to solve a variety of seemingly unrelated scientific problems that share the same mathematical structure.

Featured Problem 12.2.7 (Greenhouse Gasses and atmospheric CO_2)

Climate change has been attributed partly to the accumulation of greenhouse gasses (such as carbon dioxide and methane) in the atmosphere.

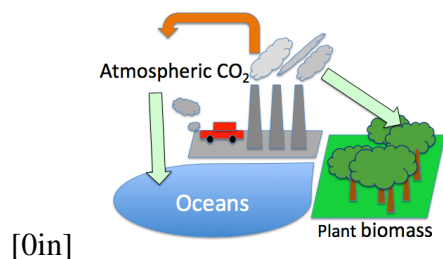

Figure 12.7: CO_2 is produced by emissions from burning fossil fuel and other human activities (orange arrow). The oceans and plant biomass are both sinks that absorb CO_2 (light green arrows).

Here we consider a simplified illustrative model for the carbon cycle that tracks the sources and sinks of CO_2 in the atmosphere. Consider $C(t)$ as the level of atmospheric carbon dioxide. Define the production rate of CO_2 due to utilization of fossil fuel and other human activity to be E_{FF} , and let the rate of absorption of CO_2 by the oceans be S_{OCEAN} . We will also assume that living plants absorb CO_2 at a rate proportional to their biomass and to the CO_2 level.

1. Explain the following differential equation for atmospheric CO₂:

$$\frac{dC}{dt} = E_{FF} - S_{OCEAN} - \gamma PC. \quad (12.2.12)$$

2. Assuming that $E_{FF}, S_{OCEAN}, \gamma, P$ are constants, find the steady state level of CO₂ in terms of these parameters.

Hint

CO₂ is usually given in units of “parts per million”, ppm (=10⁻⁶), 1 ppm = 2.1 GtC. (1GtC= 1 gigaton carbon = 10⁹ tons.)

Time is typically given in years, so rates are “per year” (yr⁻¹).

Approximate parameter values:

- $E_{FF} \approx 10 \text{ GtC yr}^{-1}$,
- $S_{OCEAN} \approx 3 \text{ GtC yr}^{-1}$,
- $P \approx 560 \text{ Gt plant biomass}$,
- $\gamma \approx 1.35 \cdot 10^{-5} \text{ yr}^{-1} \text{ Gt}^{-1}$.

3. Find $C(t)$, that is, predict the amount of CO₂ over time, assuming that $C(0) = C_0$.
4. Graph the function $C(t)$ for parameter values given in the problem, assuming that $C_0 = 400\text{ppm} = 840 \text{ GtC}$.
5. How big an effect would be produced on the CO₂ level in 50 years if 15% of the plant biomass is removed to deforestation just prior to $t = 0$?

Featured Problem 12.2.7

Note: Information for Problem 12.2.7 is adapted from the literature, and may reflect many simplifications and approximations. In actual fact, most “constants” in the problem are time-dependent, making the real problem of predicting CO₂ levels much more challenging.

12.3 ▲ Euler's method and numerical solutions

Learning Objectives

- Explain how a differential equation may be solved computationally using linear approximations. That is, explain how Euler's method works.
- Explain what each term represents in the formula for Euler's method.
- Examine and compare computational (numerical) and exact (analytical) solutions to differential equations.
- Use Euler's method to solve a differential equation by hand (small number of steps)

So far, we have explored ways of understanding the behaviour predicted by a differential equation in the form of an **analytic solution**, namely an explicit formula for the solution as a function of time. However, in reality this is typically difficult without extensive training, and occasionally, impossible even for experts. Even if we can find such a solution, it may be inconvenient to determine its numerical values at arbitrary times, or to interpret its behaviour.

For this reason, we sometimes need a method for computing an approximation for the desired solution. We refer to that approximation as a **numerical solution**. The idea is to harness a computational device - computer, laptop, or calculator - to find numerical values of points along the solution curve, rather than attempting to determine the formula for the solution as a function of time. We illustrate this process using a technique called **Euler's method**, which is based on an approximation of a derivative by the slope of a secant line.

Below, we describe how Euler's method is used to approximate the solution to a general initial value problem (differential equation together with initial condition) of the form

$$\frac{dy}{dt} = f(y), \quad y(0) = y_0.$$

Set up. We first must pick a “step size,” Δt , and subdivide the t axis into discrete steps of that size. We thus have a set of time points t_1, t_2, \dots , spaced Δt apart as shown in Figure 12.8. Our procedure starts with the known initial value $y(0) = y_0$, and uses it to generate an approximate value at the next time point (y_1), then the next (y_2), and so on. We denote by y_k the value of the independent variable generated at the k 'th time step by Euler's method as an approximation to the (unknown) true solution $y(t_k)$.

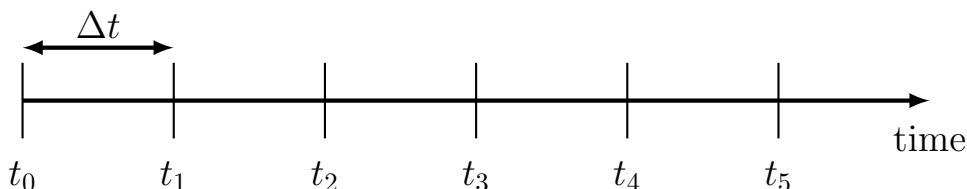

Figure 12.8: The time axis is subdivided into steps of size Δt .

Method. We approximate the differential equation by a **finite difference equation**

$$\frac{dy}{dt} = f(y) \quad \text{approximated by} \quad \frac{y_{k+1} - y_k}{\Delta t} = f(y_k).$$

Concept Check-In

1. If $\Delta t = 0.1$ and $t_0 = 0$, what are t_1, t_2 and t_3 ?
2. Explain the difference between the value y_1 and the true solution $y(t_1)$.
3. If Δt is not sufficiently small, why might Euler's method give a bad approximation to the solution?

This approximation is reasonable only when Δt , the time step size, is small. Rearranging this equation leads to a process (also called **recurrence relation**) for linking values of the solution at successive time points,

$$\frac{y_{k+1} - y_k}{\Delta t} = f(y_k), \quad \Rightarrow \quad y_{k+1} = y_k + \Delta t \cdot f(y_k). \quad (12.3.1)$$

Application. We start with the known initial value, y_0 . Then (setting the index to $k = 0$ in Eqn. (12.3.1)) we obtain

$$y_1 = y_0 + f(y_0)\Delta t.$$

The quantities on the right are known, so we can compute the value of y_1 , which is the approximation to the solution $y(t_1)$ at the time point t_1 . We can then continue to generate the value at the next time point in the same way, by approximating the derivative again as a secant slope. This leads to

$$y_2 = y_1 + f(y_1)\Delta t.$$

The approximation so generated, leading to values y_1, y_2, \dots is called **Euler's method**.

Concept Check-In

1. In Euler's method, can you determine t_2 directly? That is, without first computing t_1 ?
2. In Euler's method, can you determine y_2 directly? That is, without first computing y_1 ?

Applying this approximation repeatedly, leads to an **iteration method**, that is, the repeated computation

$$\begin{aligned} y_1 &= y_0 + f(y_0)\Delta t, \\ y_2 &= y_1 + f(y_1)\Delta t, \\ &\vdots \\ y_{k+1} &= y_k + f(y_k)\Delta t. \end{aligned}$$

From this iteration, we obtain the approximate values of the function $y_k \approx y(t_k)$ for as many time steps as desired starting from $t = 0$ in increments of Δt up to some final time T of interest.

It is customary to use the following notations:

- t_0 : the initial time point, usually at $t = 0$.
- $h = \Delta t$: common notations for the step size, i.e. the distance between the points along the t axis.
- t_k : the k 'th time point. Note that since the points are at multiples of the step size that we have picked, $t_k = k\Delta t = kh$.
- $y(t)$: the actual value of the solution to the differential equation at time t . This is usually not known, but in the examples discussed in this chapter, we can solve the differential equation exactly, so we have a formula for the function $y(t)$. In most hard scientific problems, no such formula is known in advance.

- $y(t_k)$: the actual value of the solution to the differential equation at one of the discrete time points, t_k (again, not usually known).
- y_k : the approximate value of the solution obtained by Euler's method. We hope that this approximate value is fairly close to the true value, i.e. that $y_k \approx y(t_k)$, but there is always some error in the approximation. More advanced methods that are specifically designed to reduce such errors are discussed in courses on numerical analysis.

►► Euler's method applied to population growth

We illustrate how Euler's method is used in a familiar example, that of unlimited population growth.

Example 12.3.1. Apply Euler's method to approximating solutions for the simple exponential growth model that was studied in Chapter 11,

$$\frac{dy}{dt} = ay, \quad y(0) = y_0$$

where a is a constant (see Eqn 11.1.2).

Concept Check-In

1. Carry our Example 12.3.1 with $\Delta t = 0.1$, $a = 1$, and $y_0 = 1$.
2. Plot the first 5 points you determine. Compare with the true solution.
3. Solve the initial value problem in Example 12.3.2 analytically. Compare the points $(0, 100)$, $(0.1, 95)$, $(0.2, 90.25)$ and $(0.3, 85.7375)$ with the true solution at the corresponding t values.

Solution. Subdivide the t axis into steps of size Δt , starting with $t_0 = 0$, and $t_1 = \Delta t, t_2 = 2\Delta t, \dots$. The first value of y is known from the initial condition,

$$y_0 = y(0) = y_0.$$

We replace the differential equation by the approximation

$$\frac{y_{k+1} - y_k}{\Delta t} = ay_k \quad \Rightarrow \quad y_{k+1} = y_k + a\Delta t y_k, \quad k = 1, 2, \dots$$

In particular,

$$y_1 = y_0 + a\Delta t y_0 = y_0(1 + a\Delta t),$$

$$y_2 = y_1(1 + a\Delta t),$$

$$y_3 = y_2(1 + a\Delta t),$$

and so on. At every stage, the quantity on the right hand side depends only on value of y_k that is already known from the step before. \diamond

The next example demonstrates Euler's method applied to a specific differential equation.

k	t_k	y_k
0	0	100.00
1	0.1	95.00
2	0.2	90.25
3	0.3	85.74
4	0.4	81.45
5	0.5	77.38

Table 12.3: Euler's method applied to Example 12.3.2.

Example 12.3.2. Use Euler's method to find the solution to

$$\frac{dy}{dt} = -0.5y, \quad y(0) = 100.$$

Use step size $\Delta t = 0.1$ to approximate the solution for the first two time steps.

Solution. Euler's method applied to this example would lead to

$$y_0 = 100.$$

$$y_1 = y_0(1 + a\Delta t) = 100(1 + (-0.5)(0.1)) = 95, \quad \text{etc.}$$

We show the first five values in Table 12.3. Clearly, these kinds of repeated calculations are best handled on a spreadsheet or similar computer software.

 [Link to Google Sheets. This spreadsheet implements Euler's method for Example 12.3.2. You can view the formulae by clicking on a cell in the sheet but you cannot edit the sheet here.](#)

► Euler's method applied to Newton's law of cooling

We apply Euler's method to Newton's law of cooling. Upon completion, we can directly compare the approximate numerical solution generated by Euler's method to the true (analytic) solution, (12.2.5), that we determined earlier in this chapter.

Example 12.3.3 (Newton's law of cooling). Consider the temperature of an object $T(t)$ in an ambient temperature of $E = 10^\circ$. Assume that $k = 0.2/\text{min}$. Use the initial value problem

$$\frac{dT}{dt} = k(E - T), \quad T(0) = T_0$$

to write the exact solution to Eqn. (12.2.5) in terms of the initial value T_0 .

Solution. In this case, the differential equation has the form

$$\frac{dT}{dt} = 0.2(10 - T),$$

and its analytic solution, from Eqn. (12.2.5), is

$$T(t) = 10 + (T_0 - 10)e^{-0.2t}. \tag{12.3.2}$$

◇

Below, we use Euler's method to compute a solution from each of several initial conditions, $T(0) = 0, 5, 15, 20$ degrees.

Example 12.3.4 (Euler's method applied to Newton's law of cooling). Write the Euler's method procedure for the approximate solution to the problem in Example 12.3.3.

Solution. Euler's method approximates the differential equation by

$$\frac{T_{k+1} - T_k}{\Delta t} = 0.2(10 - T_k).$$

or, in simplified form,

$$T_{k+1} = T_k + 0.2(10 - T_k)\Delta t.$$

◇

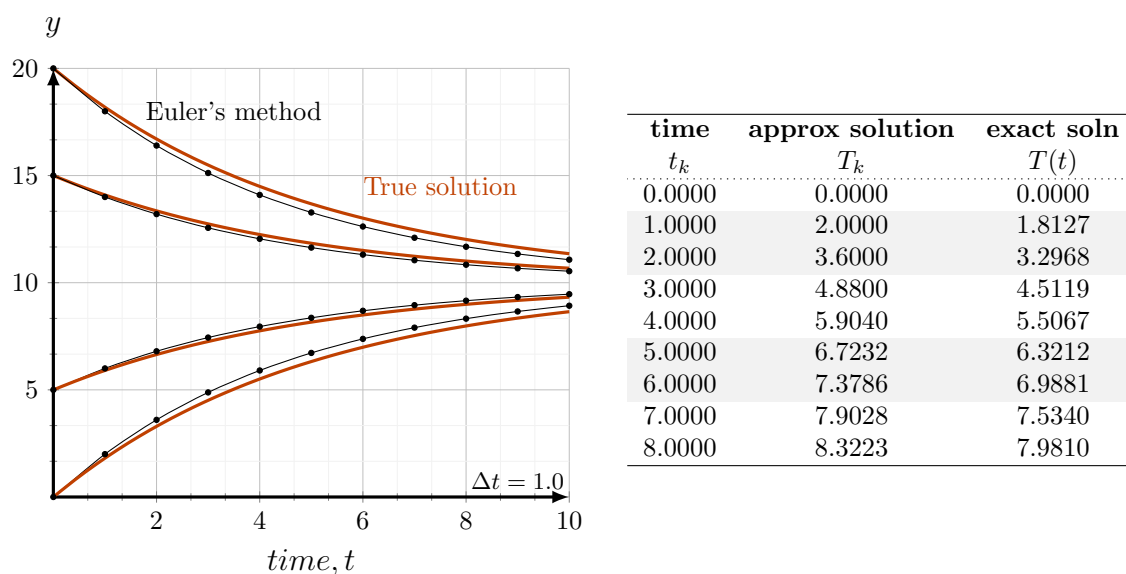

Figure 12.9: Euler's method applied to Newton's law of cooling. The graph shows the true solution (red) and the approximate solution (black).

Example 12.3.5. Use Euler's method from Example 12.3.4 and time steps of size $\Delta t = 1.0$ to find a numerical solution to the the cooling problem. Use a spreadsheet for the calculations. Note that $\Delta t = 1.0$ is not a "small step;" we use it here for illustration purposes.

Solution. The procedure to implement is

$$T_{k+1} = T_k + 0.2(10 - T_k)\Delta t.$$

In Figure 12.9 we show a typical example of the method with initial value $T(0) = T_0$ and with the time step size $\Delta t = 1.0$. Black dots represent the discrete values generated by the Euler method, starting from initial conditions, $T_0 = 0, 5, 15, 20$. Notice that the black curve is simply made up of line segments linking points obtained by the numerical solution.

Concept Check-In

1. What change would you make in the process set up in Example 12.3.5 to improve the approximation made by Euler's method?

On the same graph, we also show the analytic solution (red curves) given by Eqn. (12.3.2) with the same four initial temperatures. We see that the black and red curves start out at the same points (since they both satisfy the same initial conditions). However, the approximate solution obtained with Euler's method is not identical to the true solution. The difference between the two (gap between the red and black curves) is the **numerical error** in the approximation.

12.4 ▲ Summary

1. Given a function, we can check whether it is a solution to a differential equation by performing the appropriate differentiation and algebraic simplification.
2. Solutions to differential equations in which there is no change at all ("constant solutions") are referred to as steady states.

3. The differential equations

$$\frac{dy}{dt} = a - by, \quad y(0) = y_0$$

has a steady state solution $y = a/b$.

4. If we define the deviation from steady state, $z(t) = y(t) - \frac{a}{b}$, we get a decay equation for $z(t)$ that has exponentially decreasing solutions provided $b > 0$. This says that the deviation from steady state always decrease over time.

5. The resulting solution for $y(t)$ is

$$y(t) = \frac{a}{b} - \left(\frac{a}{b} - y_0\right) e^{-bt}.$$

6. For some differential equations, it is not always possible to determine an analytic solution (explicit formula). Numerical solutions can be found using Euler's method, and serve as an approximate solution.

7. Euler's method takes a known initial value y_0 and uses the iteration scheme:

$$y_{k+1} = y_k + f(y_k)\Delta t.$$

to generate successive values of y_k that approximate the solution at time points $t_k = k\Delta t$

8. Applications considered in this chapter included:

- (a) height of water draining out of a cylindrical container (verifying a solution to a differential equation);
- (b) Newton's law of cooling (described by a linear differential equation);
- (c) growth of the radius of a cell;

- (d) the accumulation of greenhouse gasses in the atmosphere;
- (e) friction and terminal velocity; and
- (f) chemical production and decay.

Quick Concept Checks

1. Explain why an object at room temperature is at a steady state for Newton's law of cooling.
2. The following graph depicts solution curves to a particular differential equation of the form $dy/dt = a - by$.

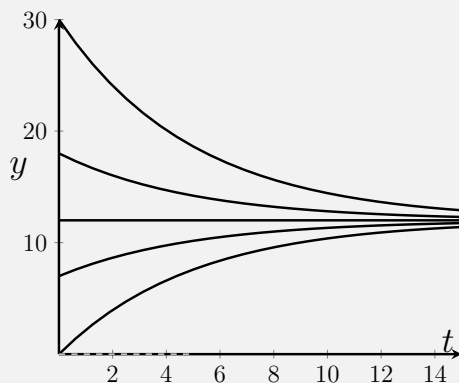

- (a) Estimate the value that these solution curves are approaching.
 - (b) Which solutions are approaching from above? From below?
3. Consider the following initial value problem:

$$\frac{dy}{dt} = 2 - 4y, \quad y(0) = 4,$$

- (a) What value does its solution curve approach?
 - (b) Does its solution approach from above or below?
4. Why is a large value of Δt not a good idea when using Euler's method?

Chapter 13

(FLAVOURS A, B) QUALITATIVE METHODS FOR DIFFERENTIAL EQUATIONS

Concept Check-In

1. What is meant by an analytic solution to a differential equation?
2. What other kind of solutions are possible?
3. Give an example of a nonlinear function $f(y)$.

Not all differential equations are easily solved analytically. Furthermore, even when we find the analytic solution, it is not necessarily easy to interpret, graph, or understand. This situation motivates qualitative methods that promote an overall understanding of behaviour - directly from information in the differential equation - without the challenge of finding a full functional form of the solution.

In this chapter we expand our familiarity with differential equations and assemble new, qualitative techniques for understanding them. We consider differential equations in which the expression on one side, $f(y)$, is **nonlinear**, i.e. equations of the form

$$\frac{dy}{dt} = f(y)$$

in which f is more complicated than the form $a - by$. Geometric techniques, rather than algebraic calculations form the core of the concepts we discuss.

13.1 ▲ Linear and nonlinear differential equations

In the model for population growth in Chapter 11, we encountered the differential equation

$$\frac{dN}{dt} = kN,$$

where $N(t)$ is population size at time t and k is a constant per capita growth rate. We showed that this differential equation has exponential solutions. It means that two behaviours are generically obtained: **explosive growth** if $k > 0$ or **extinction** if $k < 0$.

Concept Check-In

4. What happens in the case that $k = 0$? Explain under what conditions this might arise and what happens to the population $N(t)$ in this case.

The case of $k > 0$ is unrealistic, since real populations cannot keep growing indefinitely in an explosive, exponential way. Eventually running out of space or resources, the population growth dwindles, and the population attains some static level rather than expanding forever. This motivates a revision of our previous model to depict **density-dependent growth**.

►► **The logistic equation for population growth**

Let $N(t)$ represent the size of a population at time t , as before. Consider the differential equation

$$\frac{dN}{dt} = rN \frac{(K - N)}{K}. \tag{13.1.1}$$

We call this differential equation the **logistic equation**. The logistic equation has a long history in modelling population growth of humans, microorganisms, and animals. Here the parameter r is the **intrinsic growth rate** and K is the **carrying capacity**. Both r, K are assumed to be positive constants for a given population in a given environment.

In the form written above, we could interpret the logistic equation as

$$\frac{dN}{dt} = R(N) \cdot N, \quad \text{where } R(N) = \left[r \frac{(K - N)}{K} \right].$$

The term $R(N)$ is a function of N that replaces the constant rate of growth k (found in the unrealistic, unlimited population growth model). R is called the **density dependent growth rate**.

►► **Linear versus nonlinear**

The logistic equation introduces the first example of a **nonlinear differential equation**. We explain the distinction between linear and nonlinear differential equations and why it matters.

Concept Check-In

5. Can the differential equation $\frac{dy}{dt} = a - by$ be written in the form (13.1.2)? If so, what are the values of α, β, γ ?

Definition 13.1.1 (Linear differential equation). A first order differential equation is said to be linear if it is a linear combination of terms of the form

$$\frac{dy}{dt}, \quad y, \quad 1$$

that is, it can be written in the form

$$\alpha \frac{dy}{dt} + \beta y + \gamma = 0 \tag{13.1.2}$$

where α, β, γ do not depend on y . Note that “first order” means that only the first derivative (or no derivative at all) may occur in the equation.

So far, we have seen several examples of this type with constant coefficients α , β , γ . For example, $\alpha = 1$, $\beta = -k$, and $\gamma = 0$ in Eqn. 11.1.2 whereas $\alpha = 1$, $\gamma = -a$, and $\beta = b$ in Eqn. (12.2.1). A differential equation that is not of this form is said to be nonlinear.

Example 13.1.2 (Linear versus nonlinear differential equations). Which of the following differential equations are linear and which are nonlinear?

$$(a) \frac{dy}{dt} = y^2, \quad (b) \frac{dy}{dt} - y = 5, \quad (c) y \frac{dy}{dt} = -1.$$

Solution. Any term of the form y^2 , \sqrt{y} , $1/y$, etc. is nonlinear in y . A product such as $y \frac{dy}{dt}$ is also nonlinear in the independent variable. Hence equations (a), (c) are nonlinear, while (b) is linear. \diamond

Concept Check-In

6. For what values of α , β and γ can Example 13.1.2(b) be put into the form (13.1.2)?

The significance of the distinction between linear and nonlinear differential equations is that nonlinearities make it much harder to systematically find a solution to the given differential equation by “analytic” methods. Most linear differential equations have solutions that are made of exponential functions or expressions involving such functions. This is not true for nonlinear equations.

However, as we see shortly, geometric methods are very helpful in understanding the behaviour of such nonlinear differential equations.

►► Law of Mass Action

Nonlinear terms in differential equations arise naturally in various ways. One common source comes from describing interactions between individuals, as the following example illustrates.

In a chemical reaction, molecules of types A and B bind and react to form product P . Let $a(t)$, $b(t)$ denote the concentrations of A and B . These concentrations depend on time because the chemical reaction uses up both types in producing the product.

The reaction only occurs when A and B molecules “collide” and stick to one another. Collisions occur randomly, but if concentrations are larger, more collisions take place, and the reaction is faster. If either the concentration a or b is doubled, then the reaction rate doubles. But if both a and b are doubled, then the reaction rate should be four times faster, based on the higher chances of collisions between A and B .

Concept Check-In

7. If the concentration of A is tripled, and that of B is doubled, how much faster would we expect the reaction rate to be?

8. Why does the product $a \cdot b$, rather than the sum $a + b$ appear in the Law of Mass Action ?

The simplest assumption that captures this dependence is

$$\text{rate of reaction is proportional to } a \cdot b \quad \Rightarrow \quad \text{rate of reaction} = k \cdot a \cdot b$$

where k is some constant that represents the reactivity of the molecules.

We can formally state this result, known as the **Law of Mass Action** as follows:

The Law of Mass Action: The rate of a chemical reaction involving an interaction of two or more chemical species is proportional to the *product of the concentrations* of the given species.

Example 13.1.3 (Differential equation for interacting chemicals). Substance A is added at a constant rate of I moles per hour to a 1-litre vessel. Pairs of molecules of A interact chemically to form a product P . Write down a differential equation that keeps track of the concentration of A , denoted $y(t)$.

Concept Check-In

1. In each of Examples 13.1.3 and 13.1.4, clearly identify the constant quantities.

Solution. First consider the case that there is no reaction. Then, the addition of A to the reactor at a constant rate leads to changing $y(t)$, described by the differential equation

$$\frac{dy}{dt} = I.$$

When the chemical reaction takes place, the depletion of A depends on interactions of pairs of molecules. By the law of mass action, the rate of reaction is of the form $k \cdot y \cdot y = ky^2$, and as it reduces the concentration, it appear with a minus sign in the DE. Hence

$$\frac{dy}{dt} = I - ky^2.$$

This is a nonlinear differential equation - it contains a term of the form y^2 . ◇

Example 13.1.4 (Logistic equation reinterpreted). Rewrite the logistic equation in the form

$$\frac{dN}{dt} = rN - bN^2$$

(where $b = r/K$ is a positive quantity).

- a) Interpret the meaning of this restated form of the equation by explaining what each of the terms on the right hand side could represent.
- b) Which of the two terms dominates for small versus large population levels?

Solution.

- a) This form of the equation has growth term rN proportional to population size, as encountered previously in unlimited population growth. However, there is also a quadratic (nonlinear) rate of loss (note the minus sign) $-bN^2$. This term could describe interactions between individuals that lead to mortality, e.g. through fighting or competition.
- b) From familiarity with power functions (in this case, the functions of N that form the two terms, rN and bN^2) we can deduce that the second, quadratic term dominates for larger values of N , and this means that when the population is crowded, the loss of individuals is greater than the rate of reproduction. ◇

►► Scaling the logistic equation

Consider units involved in the logistic equation (13.1.1):

$$\frac{dN}{dt} = rN \frac{(K - N)}{K}.$$

This equation has two parameters, r and K . Since units on each side of an equation must balance, and must be the same for terms that are added or subtracted, we can infer that K has the same units as N , and thus it is a population density. When $N = K$, the population growth rate is zero ($dN/dt = 0$).

It turns out that we can understand the behaviour of the logistic equation by converting it to a “generic” form that does not depend on the constant K . We do so by transforming variables, which amounts to choosing a convenient way to measure the population size.

Example 13.1.5 (Rescaling). Define a new variable

$$y(t) = \frac{N(t)}{K},$$

with $N(t)$ and K as in the logistic equation. Then $N(t) = Ky(t)$.

- a) Interpret what the transformed variable y represents.
- b) Rewrite the logistic equation in terms of this variable.

Concept Check-In

10. Suppose an environment can sustain 2000 aphids per plant, and the current population size on a given plant is 1700. What is K , N and y based on this information?
11. This population is at what percent of its carrying capacity?

Solution.

- a) The variable, $y(t)$ represents a scaled version of the population density. Instead of measuring the population in some arbitrary units - such as number of individuals per acre, or number of bacteria per ml - $y(t)$ measures the population in “multiples of the carrying capacity.”

For example, if the environment can sustain 1000 aphids per plant (so $K = 1000$ individuals per plant), and the current population size on a given plant is $N = 950$ then the value of the scaled variable is $y = 950/1000 = 0.95$. We would say that “the aphid population is at 95% of its carrying capacity on the plant.”

- b) Since K is assumed constant, it follows that

$$N(t) = Ky(t) \quad \Rightarrow \quad \frac{dN}{dt} = K \frac{dy}{dt}.$$

Using this, we can simplify the logistic equation as follows:

$$\begin{aligned} \frac{dN}{dt} = rN \frac{(K - N)}{K}, \quad &\Rightarrow \quad K \frac{dy}{dt} = r(Ky) \frac{(K - Ky)}{K}, \\ &\Rightarrow \quad \frac{dy}{dt} = ry(1 - y). \end{aligned} \tag{13.1.3}$$



Eqn. (13.1.3) “looks simpler” than Eqn. (13.1.1) since it depends on only one parameter, r . Moreover, by understanding this equation, and transforming back to the original logistic in terms of $N(t) = Ky(t)$, we can interpret results for the original model. While we do not go further with transforming variables at present, it turns out that one can also further reduce the scaled logistic to an equation in which $r = 1$ by “rescaling time units”.

Concept Check-In

12. What are the units of the parameter r ?
13. How might we use the parameter r to define a time-scale?

13.2 ▲ The geometry of change

Learning Objectives

- Find linear approximations of a solution to a DE, given a point.
- Sketch a linear approximation of a solution to a DE at a point.
- Interpret slope fields for a given differential equation and use them to roughly sketch solutions.

In this section, we introduce a new method for understanding differential equations using graphical and geometric arguments. Such methods circumvent the solutions that we expressed in terms of analytic formulae. We resort to concepts learned much earlier - for example, the derivative as a slope of a tangent line - in order to use the differential equation itself to assemble a sketch of the behaviour that it predicts. That is, rather than writing down $y = F(t)$ as a solution to the differential equation (and then graphing that function) we sketch the qualitative behaviour of such solution curves directly from information contained in the differential equation.

►► Slope fields

Here we discuss a geometric way of understanding what a differential equation is saying using a **slope field**, also called a **direction field**. We have already seen that solutions to a differential equation of the form

$$\frac{dy}{dt} = f(y)$$

are curves in the (y, t) -plane that describe how $y(t)$ changes over time (thus, these curves are graphs of functions of time). Each initial condition $y(0) = y_0$ is associated with one of these curves, so that together, these curves form a *family* of solutions.

What do these curves have in common, geometrically?

- the slope of the tangent line (dy/dt) at any point on any of the curves is related to the value of the y -coordinate of that point - as stated in the differential equation.
- at any point $(t, y(t))$ on a solution curve, the tangent line must have slope $f(y)$, which depends only on the y value, and not on the time t .

Note: in more general cases, the expression $f(y)$ that appears in the differential equation might depend on t as well as y . For our purposes, we do not consider such examples in detail.

By sketching slopes at various values of y , we obtain the slope field through which we can get a reasonable idea of the behaviour of the solutions to the differential equation.

Example 13.2.1. Consider the differential equation

$$\frac{dy}{dt} = 2y. \quad (13.2.1)$$

Compute some of the slopes for various values of y and use this to sketch a slope field for this differential equation.

Concept Check-In

14. Solve Differential Eqn. (13.2.1) analytically.

Solution. Equation (13.2.1) states that if a solution curve passes through a point (t, y) , then its tangent line at that point has a slope $2y$, regardless of the value of t . This example is simple enough that we can state the following: for positive values of y , the slope is positive; for negative values of y , the slope is negative; and for $y = 0$, the slope is zero.

We provide some tabulated values of y indicating the values of the slope $f(y)$, its sign, and what this implies about the local behaviour of the solution and its direction. Then, in Figure 13.1 we





y	$f(y)$	slope of tangent line	behaviour of y	direction of arrow
-2	-4	-ve	decreasing	
-1	-2	-ve	decreasing	
0	0	0	no change	
1	2	+ve	increasing	
2	4	+ve	increasing	

Table 13.1: Table for the slope field diagram of differential equation (13.2.1), $\frac{dy}{dt} = 2y$, described in Example 13.2.1.

combine this information to generate the direction field and the corresponding solution curves. Note that the direction of the arrows (rather than their absolute magnitude) provides the most important qualitative tendency for the slope field sketch. \diamond

In constructing the slope field and solution curves, the following basic rules should be followed:

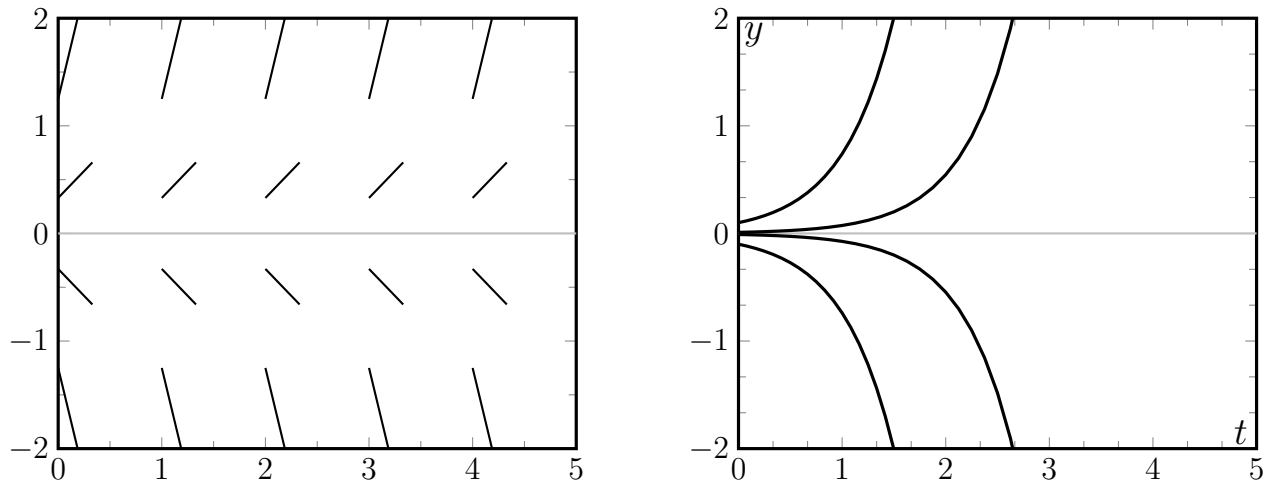

Figure 13.1: Direction field and solution curves for differential equation, $\frac{dy}{dt} = 2y$ described in Example 13.2.1.

1. By convention, time flows from left to right along the t axis in our graphs, so the direction of all arrows (not usually indicated explicitly on the slope field) is always from left to right.
2. According to the differential equation, for any given value of the variable y , the slope is given by the expression $f(y)$ in the differential equation. The sign of that quantity is particularly important in determining whether the solution is locally increasing, decreasing, or neither. In the tables, we indicate this in the last column with the notation \nearrow , \searrow , or \rightarrow .
3. There is a *single* arrow at any point in the ty -plane, and consequently solution curves cannot intersect anywhere (although they can get arbitrarily close to one another).

We see some implications of these rules in our examples.

Example 13.2.2. Consider the differential equation

$$\frac{dy}{dt} = f(y) = y - y^3. \quad (13.2.2)$$

Create a slope field diagram for this differential equation.

 A summary of steps in creating the slope field for Example 13.2.2.

Solution. Based on the last example, we focus on the sign, rather than the value of the derivative $f(y)$, since that sign determines whether the solutions increase, decrease, or stay constant. Recall that factoring helps to find zeros, and to identify where an expression changes sign. For example,

$$\frac{dy}{dt} = f(y) = y - y^3 = y(1 - y^2) = y(1 + y)(1 - y).$$

The sign of f depends on the signs of the factors y , $(1 + y)$, $(1 - y)$.

Concept Check-In

15. Graph the function $f(y) = y(1+y)(1-y)$ and indicate where it changes sign.
16. Repeat the process for the function $f(y) = y^2(1+y)^2(1-y)$.

For $y < -1$, two factors, $y, (1+y)$, are negative, whereas $(1-y)$ is positive, so that the product is positive overall. The sign of $f(y)$ changes at each of the three points $y = 0, \pm 1$ where one or another of the three factors changes sign, as shown in Table 13.2. Eventually, to the right of all three (when $y > 1$), the sign is negative. We summarize these observations in Table 13.2 and show the slopes field and solution curves in Figure 13.2. \diamond

y	sign of $f(y)$	behaviour of y	direction of arrow
$y < -1$	+ve	increasing	\nearrow
-1	0	no change	\rightarrow
-0.5	-ve	decreasing	\searrow
0	0	no change	\rightarrow
0.5	+ve	increasing	\nearrow
1	0	no change	\rightarrow
$y > 1$	-ve	decreasing	\searrow

Table 13.2: Table for the slope field diagram of the DE (13.2.2) described in Example 13.2.2.

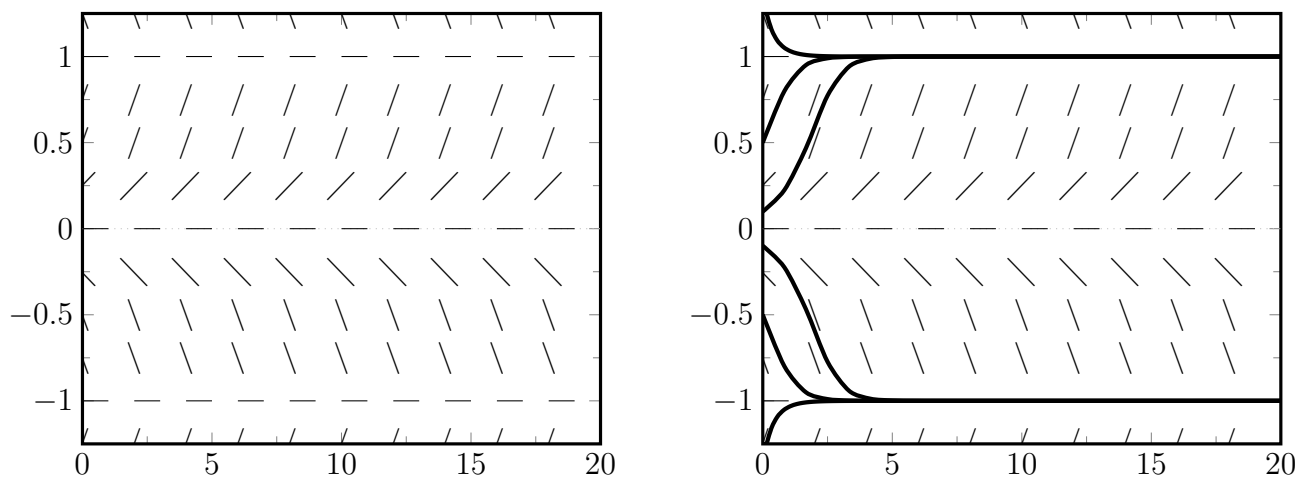

Figure 13.2: Direction field and solution curves for differential equation (13.2.2) described in Example 13.2.2.

Example 13.2.3. Sketch a slope field and solution curves for the problem of a cooling object, and specifically for

$$\frac{dT}{dt} = f(T) = 0.2(10 - T). \quad (13.2.3)$$

Solution. The family of curves shown in Figure 13.3 (also Figure 12.6) are solutions to (13.2.3). The function $f(T) = 0.2(10 - T)$ corresponds to the slopes of tangent lines to these curves. We



T	sign of $f(T)$	behaviour of T	direction of arrow
$T < 10$	+ve	increasing	
$T = 10$	0	no change	
$T > 10$	-ve	decreasing	

Table 13.3: Table for the slope field diagram of $\frac{dT}{dt} = 0.2(10 - T)$ described in Example 13.2.3.

indicate the sign of $f(T)$ and thereby the behaviour of $T(t)$ in Table 13.3. Note that there is only one change of sign, at $T = 10$. For smaller T , the solution is always increasing and for larger T , the solution is always decreasing. The slope field and solution curves are shown in Figure 13.3. In the slope field, one particular value of t is coloured to emphasize the associated changes in T , as in Table 13.3. \diamond

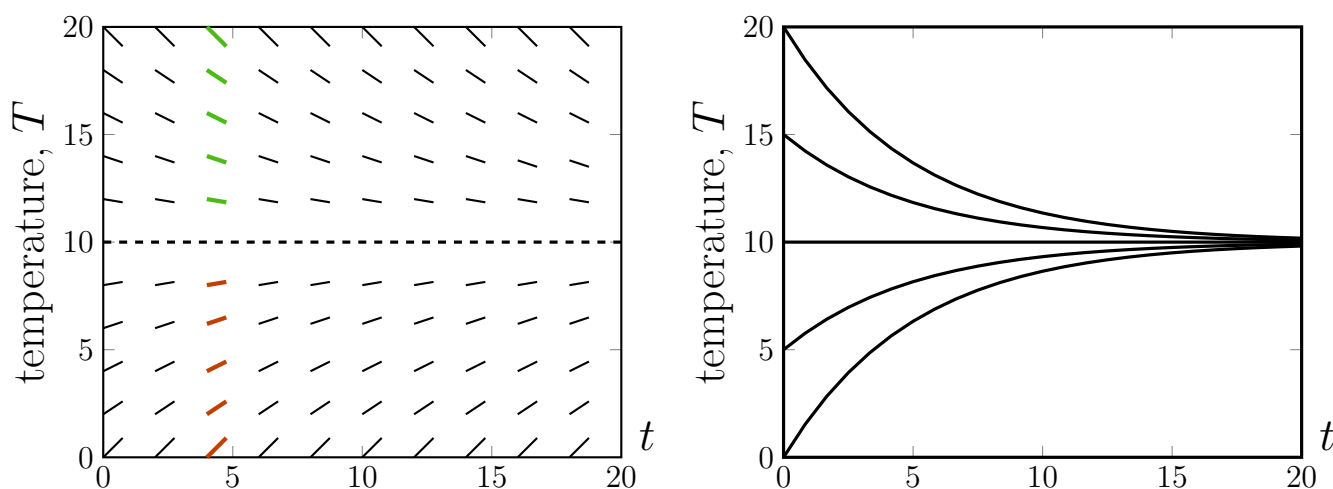

Figure 13.3: Slope field and solution curves for a cooling object that satisfies the differential equation (13.2.3) in Example 13.2.3.

Concept Check-In

- Indicate the regions Figure 13.3 where T is increasing.
- Where is T not changing in Figure 13.3?

We observe an agreement between the detailed solutions found analytically (Example 12.2.2), found using Euler's method (Example 12.3.4), and those sketched using the new qualitative arguments (Example 13.2.3).

13.3 \blacktriangle (Flavour B) State-space diagrams

Learning Objectives

- Explain what is meant by a “steady-state” solution.
- Find steady-state solutions to simple differential equations.
- Sketch a state-space diagram for a given differential equation and use it to describe the behaviour of solutions.
- Explain what it means for a steady-state solution to be “stable”. Determine the stability of a steady state.
- Use a state-space diagram to identify stability of steady states

In Examples 13.2.1-13.2.3, we saw that we can understand qualitative features of solutions to the differential equation

$$\frac{dy}{dt} = f(y), \quad (13.3.1)$$

by examining the expression $f(y)$. We used the sign of $f(y)$ to assemble a slope field diagram and sketch solution curves. The slope field informed us about which initial values of y would increase, decrease or stay constant. We next show another way of determining the same information.

First, let us define a **state space**, also called **phase line** or **phase diagram**, which is essentially the y -axis with superimposed arrows representing the direction of flow.

Definition 13.3.1 (State space diagram (or phase line)). A line representing the dependent variable (y) together with arrows to describe the flow along that line (increasing, decreasing, or stationary y) satisfying Eqn. (13.3.1) is called the **state space** diagram or the **phase line** diagram for the differential equation.

Rather than tabulating signs for $f(y)$, we can arrive at similar conclusions by sketching $f(y)$ and observing where this function is positive (implying that y increases) or negative (y decreases). Places where $f(y) = 0$ (“zeros of f ”) are important since these represent **steady states** (“static solutions”, where there is no change in y). Along the y axis (which is now on the horizontal axis of the sketch) increasing y means motion to the right, decreasing y means motion to the left.

As we shall see, the information contained in this type of diagram provides a qualitative description of solutions to the differential equation, but with the explicit time behaviour suppressed. This is illustrated by Figure 13.4, where we show the connection between the *slope field diagram* and the *state space diagram* for a typical differential equation.

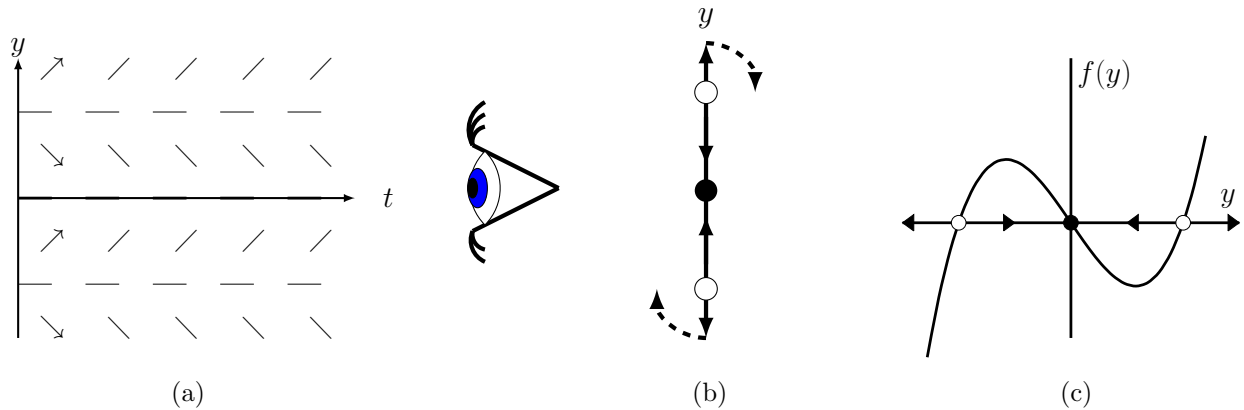

Figure 13.4: Slope field related to state space

The relationship of the slope field and state space diagrams. (a) A typical slope field. A few arrows have been added to indicate the direction of time flow along the tangent vectors. Now consider “looking down the time axis” as shown by the “eye” in this diagram. Then the t axis points towards us, and we see only the y -axis as in (b). Arrows on the y -axis indicate the directions of flow for various values of y as determined in (a). Now “rotate” the y axis so it is horizontal, as shown in (c).

The direction of the arrows exactly correspond to places where $f(y)$, in (c), is *positive* (which implies increasing y , \rightarrow), or *negative* (which implies decreasing y , \leftarrow). The state space diagram is the y -axis in (b) or (c).

Example 13.3.2. Consider the differential equation

$$\frac{dy}{dt} = f(y) = y - y^3. \quad (13.3.2)$$

Sketch $f(y)$ versus y and use your sketch to determine where y is static, and where y increases or decreases. Then describe what this predicts starting from each of the three initial conditions:

- (i) $y(0) = -0.5$,
- (ii) $y(0) = 0.3$, or
- (iii) $y(0) = 2$.

Solution. From Example 13.2.2, we know that $f(y) = 0$ at $y = -1, 0, 1$.

Video explanation of the steps in the solution to Example 13.3.2.

This means that y does not change at these steady state values, so, if we start a system off with $y(0) = 0$, or $y(0) = \pm 1$, the value of y is static. The three places at which this happens are marked by heavy dots in Figure 13.5(a).

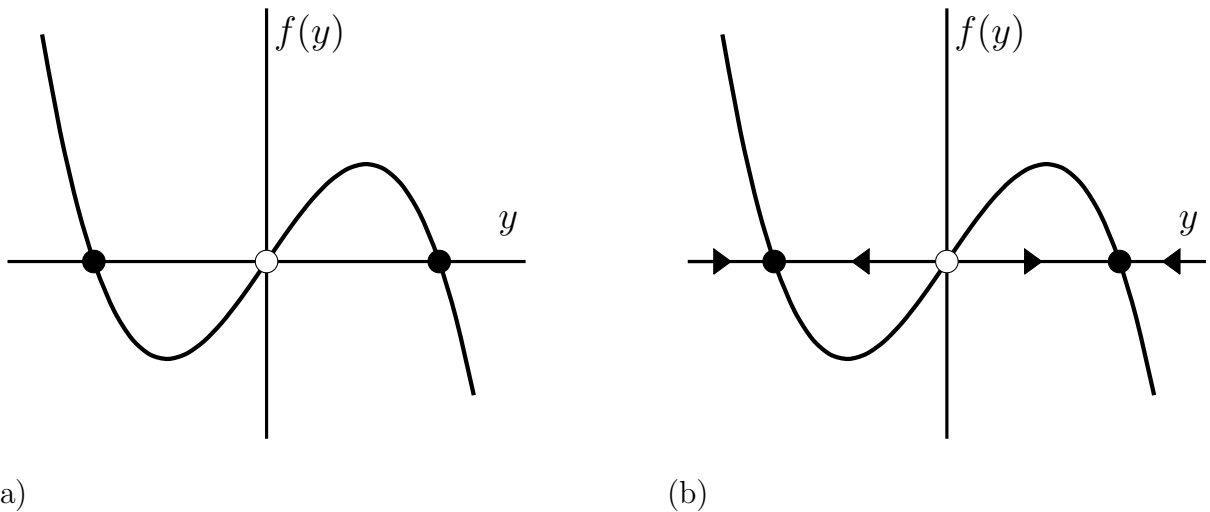

Figure 13.5: Where y is increasing, decreasing, or static

Steady states (dots) and intervals for which y increases or decreases for the differential equation (13.3.2). See Example 13.3.2.

We also see that $f(y) < 0$ for $-1 < y < 0$ and for $y > 1$. In these intervals, $y(t)$ must be a decreasing function of time ($dy/dt < 0$). On the other hand, for $0 < y < 1$ or for $y < -1$, we have $f(y) > 0$, so $y(t)$ is increasing. See arrows on Figure 13.5(b). We see from this figure that there is a tendency for y to move away from the steady state value $y = 0$ and to approach either of the steady states at 1 or -1 . Starting from the initial values given above, we have

- (i) $y(0) = -0.5$ results in $y \rightarrow -1$,
- (ii) $y(0) = 0.3$ leads to $y \rightarrow 1$, and
- (iii) $y(0) = 2$ implies $y \rightarrow 1$. ◇

Example 13.3.3 (A cooling object). Sketch the same type of diagram for the problem of a cooling object and interpret its meaning.

Solution. Here, the differential equation is

$$\frac{dT}{dt} = f(T) = 0.2(10 - T). \tag{13.3.3}$$

A sketch of the rate of change, $f(T)$ versus the temperature T is shown in Figure 13.6. We deduce the direction of the flow directly from this sketch. ◇

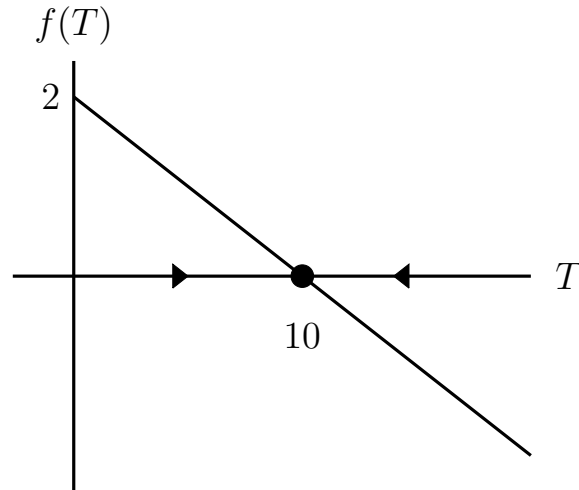

Figure 13.6: Determining flow direction

Figure for Example 13.3.3, the differential equation (13.3.3).

Concept Check-In

19. In Figures 13.6 and 13.7, where is the function positive?
20. Consider Eqn. (13.3.4) analytically: what value does y approach?

Example 13.3.4. Create a similar qualitative sketch for the more general form of linear differential equation

$$\frac{dy}{dt} = f(y) = a - by. \quad (13.3.4)$$

For what values of y would there be no change?

Solution. The rate of change of y is given by the function $f(y) = a - by$. This is shown in Figure 13.7. The steady state at which $f(y) = 0$ is at $y = a/b$. Starting from an initial condition $y(0) = a/b$, there would be no change. We also see from this figure that y approaches this value over time. After a long time, the value of y will be approximately a/b . \diamond

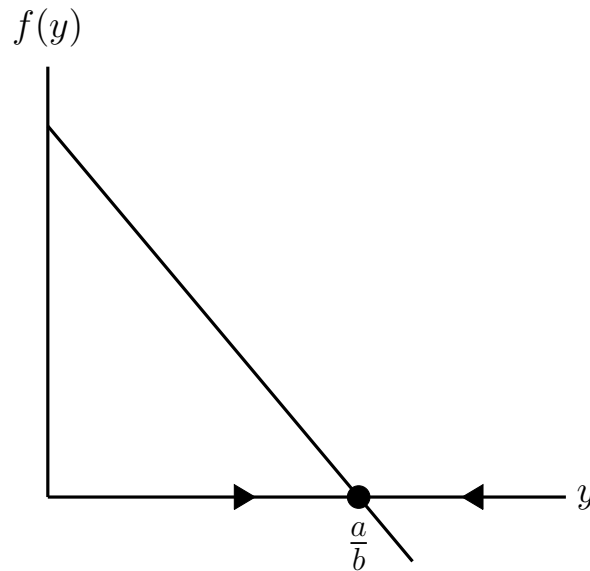

Figure 13.7: Qualitative sketch for a DE

Qualitative sketch for Eqn. (13.3.4) in Example 13.3.4.

►► Steady states and stability

From the last few figures, we observe that wherever the function f on the right hand side of the differential equations crosses the horizontal axis (satisfies $f = 0$) there is a steady state. For example, in Figure 13.6 this takes place at $T = 10$. At that temperature the differential equation specifies that $dT/dt = 0$ and so, $T = 10$ is a steady state, a concept we first encountered in Chapter 12.

Definition 13.3.5 (Steady state). A steady state is a state in which a system is not changing.

Example 13.3.6. Identify steady states of Eqn. (13.3.2),

$$\frac{dy}{dt} = y^3 - y.$$

Solution. Steady states are points that satisfy $f(y) = 0$. We already found those to be $y = 0$ and $y = \pm 1$ in Example 13.3.2. \diamond

From Figure 13.5, we see that solutions starting *close to* $y = 1$ tend to get closer and closer to this value. We refer to this behaviour as **stability** of the steady state.

Definition 13.3.7 (Stability). We say that a steady state is **stable** if states that are initially close enough to that steady state will get closer to it with time. We say that a steady state is **unstable**, if states that are initially very close to it eventually move away from that steady state.

Example 13.3.8. Determine the stability of steady states of Eqn. (13.3.2):

$$\frac{dy}{dt} = y - y^3.$$

Concept Check-In

21. In the state space diagram in Figure 13.4, identify the stable steady states.

Solution. From any starting value of $y > 0$ in this example, we see that *after a long time*, the solution curves tend to approach the value $y = 1$. States close to $y = 1$ get closer to it, so this is a stable steady state. For the steady state $y = 0$, we see that initial conditions near $y = 0$ move away over time. Thus, this steady state is unstable. Similarly, the steady state at $y = -1$ is stable. In Figure 13.5 we show the stable steady states with black dots and the unstable steady state with an open dot. \diamond

13.4 \blacktriangle Applying qualitative analysis to biological models

The qualitative ideas developed so far will now be applied to problems from biology. In the following sections we first use these methods to obtain a thorough understanding of **logistic population growth**. We then derive a model for the spread of a disease, and use qualitative arguments to analyze the predictions of that differential equation model.

►► Qualitative analysis of the logistic equation

We apply the new methods to the logistic equation.

Example 13.4.1. Find the steady states of the logistic equation, Eqn. (13.1.1):

 [The scaled logistic equation, its slope field, and steady state values are discussed here.](#)

$$\frac{dN}{dt} = rN \frac{(K - N)}{K}.$$

Solution. To determine the steady states of Eqn. (13.1.1), i.e. the level of population that would not change over time, we look for values of N such that

$$\frac{dN}{dt} = 0.$$

This leads to

$$rN \frac{(K - N)}{K} = 0,$$

which has solutions $N = 0$ (no population at all) or $N = K$ (the population is at its carrying capacity). \diamond

We could similarly find steady states of the scaled form of the logistic equation, Eqn. (13.1.3). Setting $dy/dt = 0$ leads to

$$0 = \frac{dy}{dt} = ry(1 - y) \quad \Rightarrow \quad y = 0, \text{ or } y = 1.$$

This comes as no surprise since these values of y correspond to the values $N = 0$ and $N = K$.

■ A second way to analyze the scaled logistic equation, using the phase line approach, and its connection to the slope field method as described in Example 13.4.2.

Example 13.4.2. Draw a plot of the rate of change dy/dt versus the value of y for the scaled logistic equation, Eqn. (13.1.3):

$$\frac{dy}{dt} = ry(1 - y).$$

Concept Check-In

22. Circle the steady states in Figure 13.8 and identify which one is stable.
23. Why is $y < 0$ not relevant in Example 13.4.2?

Solution. In the plot of Figure 13.8 only $y \geq 0$ is relevant. In the interval $0 < y < 1$, the rate of change is positive, so that y increases, whereas for $y > 1$, the rate of change is negative, so y decreases. Since y refers to population size, we need not concern ourselves with behaviour for $y < 0$. From Figure 13.8 we deduce that solutions that start with a positive y value approach $y = 1$ with

Rate of change

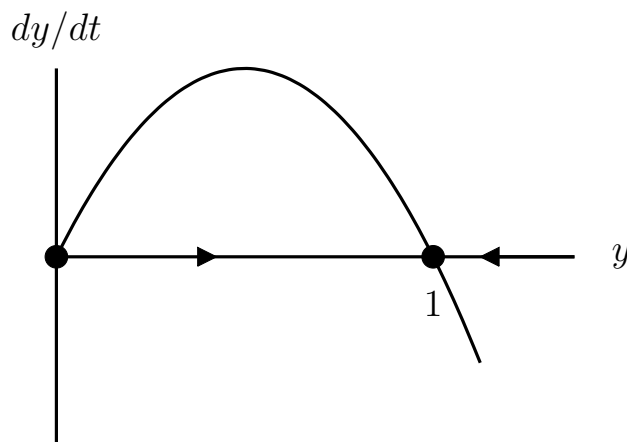

Figure 13.8: Plot of dy/dt versus y for the the scaled logistic equation (13.1.3).

time. Solutions starting at either steady state $y = 0$ or $y = 1$ would not change. Restated in terms of the variable $N(t)$, any initial population should approach its carrying capacity K with time. \diamond

We now look at the same equation from the perspective of the slope field.

Example 13.4.3. Draw a slope field for the scaled logistic equation with $r = 0.5$, that is for

$$\frac{dy}{dt} = f(y) = 0.5 \cdot y(1 - y). \tag{13.4.1}$$

Solution. We generate slopes for various values of y in Table 13.4 and plot the slope field in Figure 13.9(a). \diamond

Finally, we practice Euler's method to graph the numerical solution to Eqn. (13.4.1) from several initial conditions.

y	sign of $f(y)$	behaviour of y	direction of arrow
0	0	no change	→
$0 < y < 1$	+ve	increasing	↗
1	0	no change	→
$y > 1$	-ve	decreasing	↘

Table 13.4: Table for slope field for the logistic equation (13.4.1). See Fig 13.9(a) for the resulting diagram.

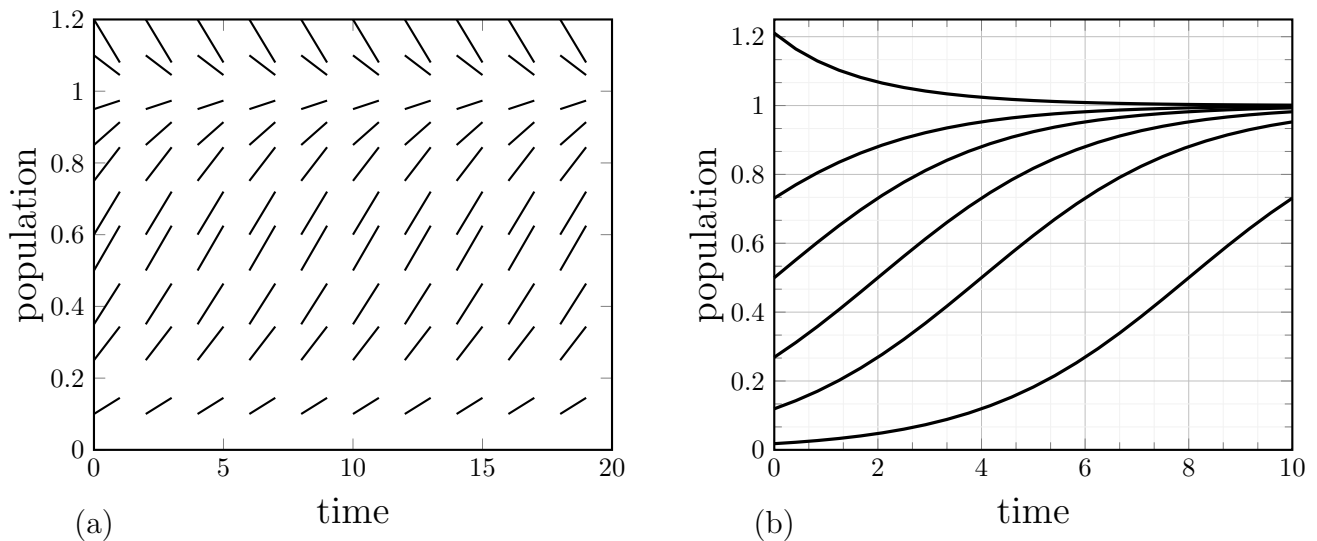

Figure 13.9: (a) Slope field and (b) solution curves for the logistic equation (13.4.1), $\frac{dy}{dt} = 0.5 \cdot y(1 - y)$

Example 13.4.4 (Numerical solutions to the logistic equation). Use Euler’s method to approximate the solutions to the logistic equation (13.4.1).

Concept Check-In

24. What initial values y_0 were used in drawing the different solution curves depicted in Figure 13.9(b)?

Solution. In Figure 13.9(b) we show a set of solution curves, obtained by solving the equation numerically using Euler’s method. To obtain these solutions, a value of $h = \Delta t = 0.1$ was used. The solution is plotted for various initial conditions $y(0) = y_0$. The successive values of y were calculated according to

$$y_{k+1} = y_k + 0.5y_k(1 - y_k)h, \quad k = 0, \dots, 100.$$

 [Link to Google Sheets.](#) This spreadsheet implements Euler's method for Example 13.4.4. A chart showing solutions from four initial conditions is included.

From Figure 13.9(b), we see that solution curves approach the steady state $y = 1$, meaning that the population $N(t)$ approaches the carrying capacity K for all positive starting values. A link to the spreadsheet that implements Euler's method is included. \diamond

Example 13.4.5 (Inflection points). Some of the curves shown in Figure 13.9(b) have an inflection point, but others do not. Use the differential equation to determine which of the solution curves have an inflection point.

Solution. We have already established that all initial values in the range $0 < y_0 < 1$ are associated with increasing solutions $y(t)$. Now we consider the concavity of those solutions.

Concept Check-In

25. How do we know that initial conditions in the range $0 < y_0 < 1$ lead to increasing solutions?

The logistic equation has the form

$$\frac{dy}{dt} = ry(1 - y) = ry - ry^2$$

Differentiate both sides using the chain rule and factor, to get

$$\frac{d^2y}{dt^2} = r \frac{dy}{dt} - 2ry \frac{dy}{dt} = r \frac{dy}{dt} (1 - 2y).$$

An inflection point would occur at places where the second derivative changes sign. This is possible for $dy/dt = 0$ or for $(1 - 2y) = 0$. We have already dismissed the first possibility because we argued that the rate of change is nonzero in the interval of interest. Thus we conclude that an inflection point would occur whenever $y = 1/2$. Any initial condition satisfying $0 < y_0 < 1/2$ would eventually pass through $y = 1/2$ on its way to the steady state level at $y = 1$, and in so doing, would have an inflection point. \diamond

►► A changing aphid population

In Chapter 1, we investigated a situation when predation and growth rates of an aphid population exactly balanced. But what happens if these two rates do not balance? We are now ready to tackle this question.

Featured Problem 13.4.6 (aphids)

Hint

Growth rate (number of aphids born per unit time) contributes positively, whereas predation rate (number of aphids eaten per unit time) contributes negatively to the rate of change of aphids with respect to time (dx/dt).

Consider the aphid-ladybug problem (Example 1.4.1) with aphid density x , growth rate $G(x) = rx$, and predation rate by a ladybug $P(x)$ as in (1.4.1). (a) Write down a differential equation for the aphid population. (b) Use your equation, and a sketch of the two functions to answer the following question: What happens to the aphid population starting from various initial population sizes?

Featured Problem 13.4.6

►► A model for the spread of a disease

In the era of human immunodeficiency virus (HIV), Severe Acute Respiratory Syndrome (SARS), Avian influenza (“bird flu”) and similar emerging infectious diseases, it is prudent to consider how infection spreads, and how it could be controlled or suppressed. This motivates the following example.

For a given disease, let us subdivide the population into two classes: healthy individuals who are susceptible to catching the infection, and those that are currently infected and able to transmit the infection to others. We consider an infection that is mild enough that individuals recover at some constant rate, and that they become susceptible once recovered.

Note: usually, recovery from an illness leads to partial temporary immunity. While this, too, can be modelled, we restrict attention to the simpler case which is tractable using mathematics we have just introduced.

The simplest case to understand is that of a fixed population (with no birth, death or migration during the timescale of interest). A goal is to predict whether the infection spreads and persists (becomes endemic) in the population or whether it runs its course and disappears.

 A video summary of the model for the spread of a disease, together with its analysis.

We use the following notation:

$S(t)$ = size of population of susceptible (healthy) individuals,

$I(t)$ = size of population of infected individuals,

$N(t) = S(t) + I(t)$ = total population size.

We add a few simplifying assumptions.

1. The population mixes very well, so each individual is equally likely to contact and interact with any other individual. The contact is random.
2. Other than the state (S or I), individuals are “identical,” with the same rates of recovery and infectivity.
3. On the timescale of interest, there is no birth, death or migration, only exchange between S and I .

Example 13.4.7. Suppose that the process can be represented by the scheme

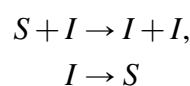

The first part, transmission of disease from I to S involves interaction. The second part is recovery. Use the assumptions above to track the two populations and to formulate a set of differential equations for $I(t)$ and $S(t)$.

Solution. The following balance equations keeps track of individuals

$$\begin{bmatrix} \text{Rate of} \\ \text{change of} \\ I(t) \end{bmatrix} = \begin{bmatrix} \text{Rate of gain} \\ \text{due to disease} \\ \text{transmission} \end{bmatrix} - \begin{bmatrix} \text{Rate of loss} \\ \text{due to} \\ \text{recovery} \end{bmatrix}$$

According to our assumption, recovery takes place at a constant rate per unit time, denoted by $\mu > 0$. By the law of mass action, the disease transmission rate should be proportional to the product of the populations, $(S \cdot I)$. Assigning $\beta > 0$ to be the constant of proportionality leads to the following differential equations for the infected population:

$$\frac{dI}{dt} = \beta SI - \mu I.$$

Similarly, we can write a balance equation that tracks the population of susceptible individuals:

$$\begin{bmatrix} \text{Rate of} \\ \text{change of} \\ S(t) \end{bmatrix} = - \begin{bmatrix} \text{Rate of Loss} \\ \text{due to disease} \\ \text{transmission} \end{bmatrix} + \begin{bmatrix} \text{Rate of gain} \\ \text{due to} \\ \text{recovery} \end{bmatrix}$$

Observe that loss from one group leads to (exactly balanced) gain in the other group. By similar logic, the differential equation for $S(t)$ is then

$$\frac{dS}{dt} = -\beta SI + \mu I.$$

We have arrived at a **system of equations** that describe the changes in each of the groups,

$$\frac{dI}{dt} = \beta SI - \mu I, \tag{13.4.2a}$$

$$\frac{dS}{dt} = -\beta SI + \mu I. \tag{13.4.2b}$$

◇

Concept Check-In

26. Identify any constants in Eqns. (13.4.2)(a) and (b).
27. What are the units of those constants?
28. Why does the hint given in Example 13.4.8 help?

From Eqns. (13.4.2) it is clear that changes in one population depend on both, which means that the differential equations are **coupled** (linked to one another). Hence, we cannot “solve one” independently of the other. We must treat them as a pair. However, as we observe in the next examples, we can simplify this system of equations using the fact that the total population does not change.

Example 13.4.8. Use Eqns.(13.4.2) to show that the total population does not change (*hint*: show that the derivative of $S(t) + I(t)$ is zero).

 Video showing that the population $N(t) = I(t) + S(t)$ is constant.

Solution. Add the equations to one another. Then we obtain

$$\frac{d}{dt}[I(t) + S(t)] = \frac{dI}{dt} + \frac{dS}{dt} = \beta SI - \mu I - \beta SI + \mu I = 0.$$

Hence

$$\frac{d}{dt}[I(t) + S(t)] = \frac{dN}{dt} = 0,$$

which mean that $N(t) = [I(t) + S(t)] = N = \text{constant}$, so the total population does not change. (In Eqn. (13.1.1), here N is a constant and $I(t), S(t)$ are the variables.) \diamond

Example 13.4.9. Use the fact that N is constant to express $S(t)$ in terms of $I(t)$ and N , and eliminate $S(t)$ from the differential equation for $I(t)$. Your equation should only contain the constants N, β, μ .

Concept Check-In

29. Redo Example 13.4.9 but eliminate $I(t)$ instead of $S(t)$.
30. Analyze the equation you get for $dS(t)/dt$ as done for dI/dt in Example 13.4.10.

Solution. Since $N = S(t) + I(t)$ is constant, we can write $S(t) = N - I(t)$. Then, plugging this into the differential equation for $I(t)$ we obtain

$$\frac{dI}{dt} = \beta SI - \mu I, \quad \Rightarrow \quad \frac{dI}{dt} = \beta(N - I)I - \mu I.$$

\diamond

Example 13.4.10. a) Show that the above equation can be written in the form

$$\frac{dI}{dt} = \beta I(K - I),$$

where K is a constant.

- b) Determine how this constant K depends on N, β , and μ .
- c) Is the constant K positive or negative?

Solution.

a) We rewrite the differential equation for $I(t)$ as follows:

$$\frac{dI}{dt} = \beta(N - I)I - \mu I = \beta I \left((N - I) - \frac{\mu}{\beta} \right) = \beta I \left(N - \frac{\mu}{\beta} - I \right).$$

b) We identify the constant,

$$K = \left(N - \frac{\mu}{\beta} \right).$$

c) Evidently, K could be *either positive or negative*, that is

$$\begin{cases} N \geq \frac{\mu}{\beta} & \Rightarrow K \geq 0, \\ N < \frac{\mu}{\beta} & \Rightarrow K < 0. \end{cases}$$

◇

Using the above process, we have reduced the system of two differential equations for the two variables $I(t)$, $S(t)$ to a *single* differential equation for $I(t)$, together with the statement $S(t) = N - I(t)$. We now examine implications of this result using the qualitative methods of this chapter.

Example 13.4.11. Consider the differential equation for $I(t)$ given by

$$\frac{dI}{dt} \equiv f(I) = \beta I(K - I), \quad \text{where } K = \left(N - \frac{\mu}{\beta}\right). \quad (13.4.3)$$

Find the steady states of the differential equation (13.4.3) and draw a state space diagram in each of the following cases:

(a) $K \geq 0$,

(b) $K < 0$.

Use your diagram to determine which steady state(s) are stable or unstable.

Concept Check-In

31. What is the significance of the grey shaded regions in Fig. 13.10.
32. Draw Fig. 13.10 for $K = 0$.
33. Why is $I = K$ not an admissible steady state if $K < 0$?

Solution. Steady states of Eqn. (13.4.3) satisfy $dI/dt = \beta I(K - I) = 0$. Hence, these steady states are $I = 0$ (no infected individuals) and $I = K$. The latter only makes sense if $K \geq 0$. We plot the function $f(I) = \beta I(K - I)$ in Eqn. (13.4.3) against the state variable I in Figure 13.10 (a) for $K \geq 0$ and (b) for $K < 0$. Since $f(I)$ is quadratic in I , its graph is a parabola and it opens downwards. We add arrows pointing right (\rightarrow) in the regions where $dI/dt > 0$ and arrows pointing left (\leftarrow) where $dI/dt < 0$.

In case (a), when $K \geq 0$, we find that arrows point toward $I = K$, so this steady state is stable. Arrows point away from $I = 0$, so this represents an unstable steady state. In case (b), while we still have a parabolic graph with two steady states, the state $I = K$ is not admissible since K is negative. Hence only one steady state, at $I = 0$ is relevant biologically, and all initial conditions move towards this state. ◇

Example 13.4.12. Interpret the results of the model in terms of the disease, assuming that initially most of the population is in the susceptible S group, and a small number of infected individuals are present at $t = 0$.

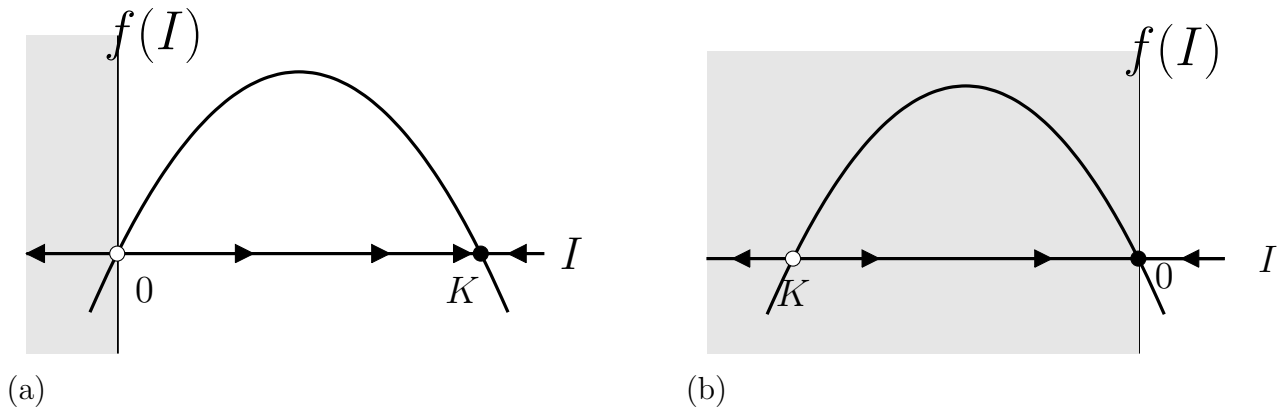

Figure 13.10: State-space diagrams for differential equation (13.4.3). Plots of $f(I)$ as a function of I in the cases (a) $K \geq 0$, and (b) $K < 0$. The grey regions are not biologically meaningful since I cannot be negative.

Solution. In case (a), as long as the initial size of the infected group is positive ($I > 0$), with time it approaches K , that is, $I(t) \rightarrow K = N - \mu/\beta$. The rest of the population is in the susceptible group, that is $S(t) \rightarrow \mu/\beta$ (so that $S(t) + I(t) = N$ is always constant.) This first scenario holds provided $K > 0$ which is equivalent to $N > \mu/\beta$. There are then some infected and some healthy individuals in the population indefinitely, according to the model. In this case, we say that the disease becomes **endemic**.

In case (b), which corresponds to $N < \mu/\beta$, we see that $I(t) \rightarrow 0$ regardless of the initial size of the infected group. In that case, $S(t) \rightarrow N$ so with time, the infected group shrinks and the healthy group grows so that the whole population becomes healthy. From these two results, we conclude that the disease is wiped out in a small population, whereas in a sufficiently large population, it can spread until a steady state is attained where some fraction of the population is always infected. In fact we have identified a *threshold* that separates these two behaviours:

Concept Check-In

34. In the case that $\beta = 0.001$ per person per day and $\mu = 0.1$ per day, how large would the population have to be for the disease to become endemic?
35. Frequent hand-washing can be a protective measure that decreases the spread of disease. Which parameter of the model would this affect and in what way?

$$\frac{N\beta}{\mu} > 1 \Rightarrow \text{disease becomes endemic,}$$

$$\frac{N\beta}{\mu} < 1 \Rightarrow \text{disease is wiped out.}$$

A video summarizing the interpretation of the model and the meaning of the constant $R_0 = N\beta/\mu$.

The ratio of constants in these inequalities, $R_0 = N\beta/\mu$ is called the **basic reproduction number** for the disease. Many current and much more detailed models for disease transmission also have

such threshold behaviour, and the ratio that determines whether the disease spreads or disappears, R_0 is of great interest in vaccination strategies. This ratio represents the number of infections that arise when 1 infected individual interacts with a population of N susceptible individuals.

13.5 ▲ Summary

1. A differential equation of the form $\alpha \frac{dy}{dt} + \beta y + \gamma = 0$ is linear (and “first order”). We encountered several examples of nonlinear DEs in this chapter.
2. A (possibly nonlinear) differential equation $\frac{dy}{dt} = f(y)$ can be analyzed qualitatively by observing where $f(y)$ is positive, negative or zero.
3. A slope field (or “direction field”) is a collection of tangent vectors for solutions to a differential equation. Slope fields can be sketched from $f(y)$ without the need to solve the differential equation.
4. A solution curve drawn in a slope field corresponds to a single solution to a differential equation, with some initial y_0 value given.
5. A state space (or “phase line” diagram) for the differential equation is a y axis, together with arrows describing the flow (increasing/decreasing/stationary) along that axis. It can be obtained from a sketch of $f(y)$.
6. A steady state is stable if nearby states get closer. A steady state is unstable if nearby states get further away with time.
7. Creating/interpreting slope field and state space diagrams is helpful in understanding the behavior of solutions to differential equations.
8. Applications considered in this chapter included:
 - (a) the logistic equations for population growth (a nonlinear differential equation, scaling, steady state and slope field demonstration);
 - (b) the Law of Mass Action (a nonlinear differential equation);
 - (c) a cooling object (state space and phase line diagram demonstration); and
 - (d) disease spread model (an extensive exposition on qualitative differential equation methods).

Quick Concept Check

1. Why is it helpful to rescale an equation?
2. Identify which of the following differential equations are linear:

(a) $5 \frac{dy}{dt} - y = -0.5$

(c) $\frac{dy}{dx} + \pi y + \rho = 3$

(b) $\left(\frac{dy}{dt}\right)^2 + y + 1 = 0$

(d) $\frac{dx}{dt} + x + 2 = -3x$

3. Consider the following slope field:

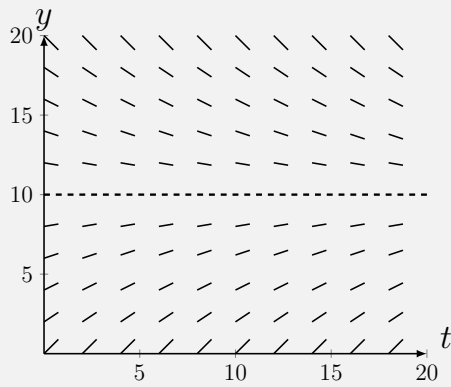

(a) Where is y decreasing?

(b) What is y approaching?

4. Circle the **stable** steady states in the following state space diagram

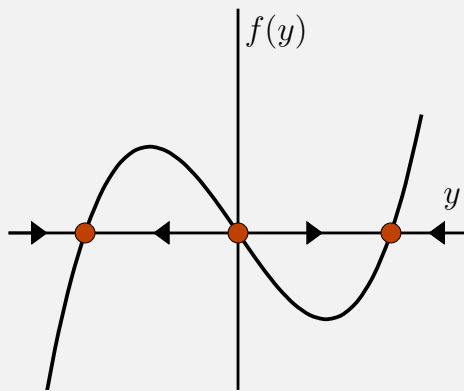

Application to Multivariable Equations

Chapter 14

(FLAVOUR C) GEOMETRY
IN THREE DIMENSIONS

Before we get started doing calculus in two and three dimensions we need to brush up on some basic geometry that we will use a lot. We are already familiar with the Cartesian plane¹, but we'll start from the beginning.

14.1 ▲ Points and planes

Learning Objectives

- Label points on the x - y - z axes and identify basic planes of constant x , y , or z .

Each point in two dimensions may be labeled by two coordinates² (x, y) which specify the position of the point in some units with respect to some axes as in the figure below.

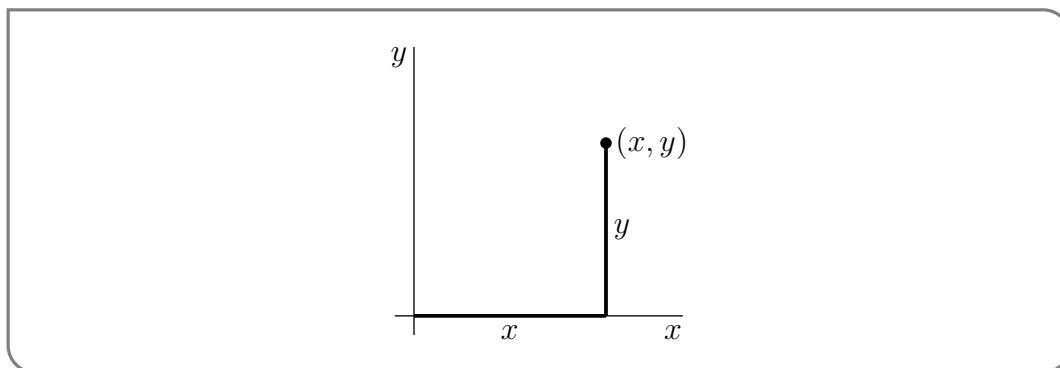

- 1 René Descartes (1596–1650) was a French scientist and philosopher, who lived in the Dutch Republic for roughly twenty years after serving in the (mercenary) Dutch States Army. He is viewed as the father of analytic geometry, which uses numbers to study geometry.
- 2 This is why the xy -plane is called “two dimensional” — the name of each point consists of two real numbers.

The set of all points in two dimensions is denoted³ \mathbb{R}^2 . Observe that

- the distance from the point (x, y) to the x -axis is $|y|$
- the distance from the point (x, y) to the y -axis is $|x|$
- the distance from the point (x, y) to the origin $(0, 0)$ is $\sqrt{x^2 + y^2}$

Similarly, each point in three dimensions may be labeled by three coordinates (x, y, z) , as in the two figures below.

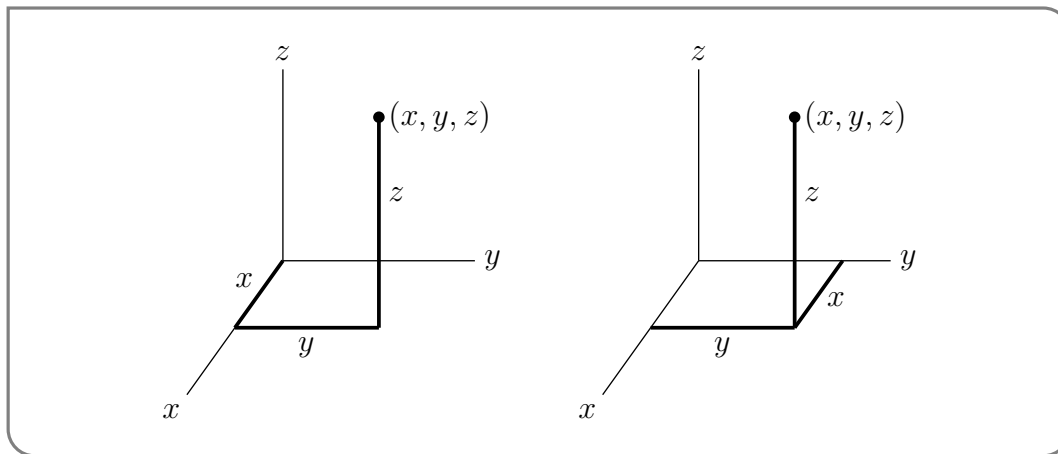

The set of all points in three dimensions is denoted \mathbb{R}^3 . The plane that contains, for example, the x - and y -axes is called the xy -plane.

- The xy -plane is the set of all points (x, y, z) that satisfy $z = 0$.
- The xz -plane is the set of all points (x, y, z) that satisfy $y = 0$.
- The yz -plane is the set of all points (x, y, z) that satisfy $x = 0$.

More generally,

- The set of all points (x, y, z) that obey $z = c$ is a plane that is parallel to the xy -plane and is a distance $|c|$ from it. If $c > 0$, the plane $z = c$ is above the xy -plane. If $c < 0$, the plane $z = c$ is below the xy -plane. We say that the plane $z = c$ is a signed distance c from the xy -plane.
- The set of all points (x, y, z) that obey $y = b$ is a plane that is parallel to the xz -plane and is a signed distance b from it.
- The set of all points (x, y, z) that obey $x = a$ is a plane that is parallel to the yz -plane and is a signed distance a from it.

³ Not surprisingly, the 2 in \mathbb{R}^2 signifies that each point is labelled by two numbers and the \mathbb{R} in \mathbb{R}^2 signifies that the numbers in question are real numbers. There are more advanced applications (for example in signal analysis and in quantum mechanics) where complex numbers are used. The space of all pairs (z_1, z_2) , with z_1 and z_2 complex numbers is denoted \mathbb{C}^2 .

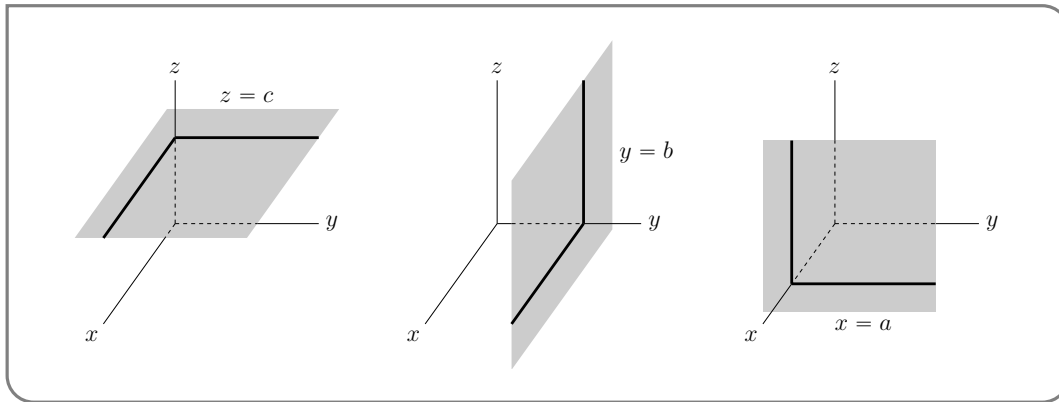

Observe that our 2d distances extend quite easily to 3d.

- the distance from the point (x, y, z) to the xy -plane is $|z|$
- the distance from the point (x, y, z) to the xz -plane is $|y|$
- the distance from the point (x, y, z) to the yz -plane is $|x|$
- the distance from the point (x, y, z) to the origin $(0, 0, 0)$ is $\sqrt{x^2 + y^2 + z^2}$

To see that the distance from the point (x, y, z) to the origin $(0, 0, 0)$ is indeed $\sqrt{x^2 + y^2 + z^2}$,

- apply Pythagoras to the right-angled triangle with vertices $(0, 0, 0)$, $(x, 0, 0)$ and $(x, y, 0)$ to see that the distance from $(0, 0, 0)$ to $(x, y, 0)$ is $\sqrt{x^2 + y^2}$ and then
- apply Pythagoras to the right-angled triangle with vertices $(0, 0, 0)$, $(x, y, 0)$ and (x, y, z) to see that the distance from $(0, 0, 0)$ to (x, y, z) is $\sqrt{(\sqrt{x^2 + y^2})^2 + z^2} = \sqrt{x^2 + y^2 + z^2}$.

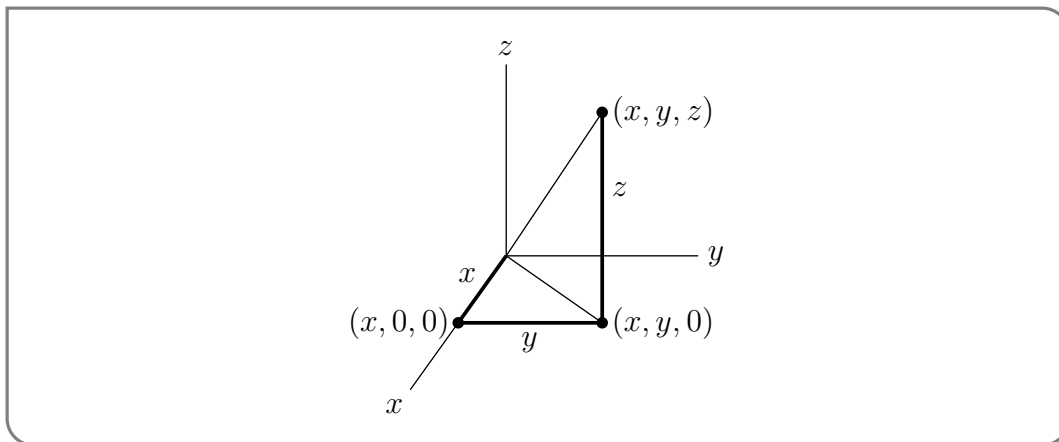

More generally, the distance from the point (x, y, z) to the point (x', y', z') is

$$\sqrt{(x - x')^2 + (y - y')^2 + (z - z')^2}$$

Notice that this gives us the equation for a sphere quite directly. All the points on a sphere are equidistant from the centre of the sphere. So, for example, the equation of the sphere centered on $(1, 2, 3)$ with radius 4, that is, the set of all points (x, y, z) whose distance from $(1, 2, 3)$ is 4, is

$$(x - 1)^2 + (y - 2)^2 + (z - 3)^2 = 16$$

If you're having a hard time picturing the three-dimensional axes, Appendix section 14.1.1 will lead you through folding a model out of a piece of paper.

14.1.1 ▶▶ (optional) Folding the first octant of \mathbb{R}^3

This text, whether you're reading it on a computer screen or a printed page, exists in two dimensions. So, anything we draw in three dimensions is going to require a little bit of imagination. If you're struggling to understand the figures with three coordinates, it might help to make your own model of these axes.

In the Cartesian plane, the first quadrant is the part of the plane where both x and y are positive. \mathbb{R}^3 divides three-dimensional space into eight regions, called octants. The first octant is the region where all of x , y , and z are positive.

Following the instructions below, you can fold a piece of paper into an octant.

1. Fold your paper in half “hamburger style” (so that the fold goes along the shorter dimension of the paper). Position it so that it opens like a book⁴.

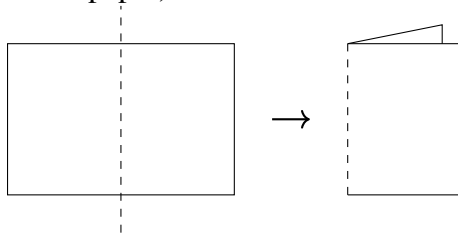

2. Bring the corner of your folded paper up to the side.

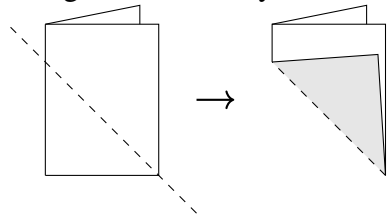

3. Your paper now has a triangle sitting on top of a rectangle. Where the triangle ends, make a crease in the underlying rectangle shapes.

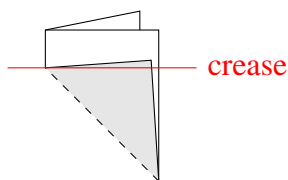

4. Your paper has four layers, with the triangle shapes on top. Open the paper so that three layers are on top, and one is on the bottom. The result should look like the inside corner of a box.

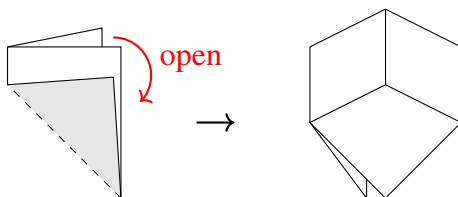

Your octant is created! The vertical crease is the z axis, the crease to the left is the x axis, and the crease to the right is the y axis. In the picture below, the blue sphere indicates that the octant is open towards you: if you were to put a marble inside the paper structure, it would sit as shown.

4 in a language written left-to-right

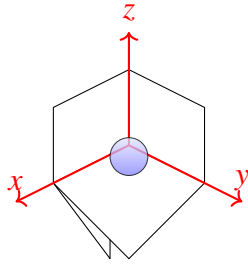

To practice with your octant, label the following points directly on the paper:

- (1, 1, 0)
- (0, 1, 1)
- (1, 0, 1)

The next collection of points will exist out in space, not on any of the paper sides. Point to their positions relative to your octant:

- (1, 1, 1)
- (1, 2, 3)
- (1, -1, 1)
- (1, 1, -1)

14.2 ▲ Functions of two variables

Learning Objectives

- Given a simple function of two variables, $z = f(x, y)$, evaluate z values for given pairs (x, y) .

First, a quick review of dependent and independent variables. *Independent variables* are the variables we think of as changing somehow on their own; the *dependent variables* are the variables whose change we think of as being caused by the independent variables. For example, if you want to describe the relationship between the age of a cup of cottage cheese, and the number of bacteria in that cup, we generally choose age (time) to be the independent variable and population of bacteria to be the dependent variable: we think of age changing on its own, then that age causing the bacterial population to change.

We could of course go the other way, and write time as a function of bacteria. This could be useful if we were trying to figure out how old the cheese was by counting its bacteria. So the difference between an independent variable and a dependent variable has to do with how we want to interpret a function.

In a single-variable function, by convention we write

$$y = f(x)$$

where y is the dependent variable and x is the independent variable. Similarly, in a two-variable function, we generally write

$$z = f(x, y)$$

We think of the variables x and y as independent, and the variable z as dependent.

If we're not too concerned with independent vs dependent variables; or if the relationship between the dependent and independent variables is difficult (or impossible) to write explicitly in this form; then we can also define multivariable functions implicitly. For example, in the equation

$$z^3x + z^2y + xyz - 1 = 0$$

we can think of z as an implicitly defined function of x and y . You've already seen two families of implicitly defined functions: planes and spheres.

Example 14.2.1

Which points $(1, y, 1)$ in \mathbb{R}^3 satisfy the equation

$$z^3x + z^2y + xyz - 1 = 0?$$

Solution. If $x = z = 1$, then the equation becomes

$$1 + y + y - 1 = 0$$

which has solution $y = 0$. So the only such point is $(1, 0, 1)$.

Example 14.2.1

It's common to see a multivariable equation like

$$f(x, y) = \sin(x + y)$$

or

$$g(x, y) = e^{x^2+y^2}$$

and think that the sine and exponential functions are different from the sine and exponential functions we've seen in two dimensions. They aren't! When x and y are real numbers, then $(x + y)$ and $(x^2 + y^2)$ are real numbers as well. We're taking the sine of a real number in the first equation, and e to a real power in the second equation, just as we always have.

Functions of two (or more) variables are not so different from functions of one variable in other ways as well.

Definition 14.2.2 (Domain and Range).

Let $f(x, y)$ be a function that takes pairs of real numbers as inputs, and gives a real number as its output.

The set of points (x, y) that can be input to f is the **domain** of that function. The set of outputs of f over its entire domain is the **range** of that function.

Example 14.2.3 (Domain and Range)

Find the domain and range of the function

$$f(x, y) = \sqrt{e^{x^2+y^2} - 2}$$

Solution. There are three operations in our function: exponentiation, subtraction, and taking of a square root. We can subtract anything from anything; and we can raise e to any power. So the only thing that could “break” our function is if we tried to take the square root of a negative number. This tells us that, in order for $f(x, y)$ to be defined, we need

$$\begin{aligned} (e^{x^2+y^2} - 2) &\geq 0 \\ \implies e^{x^2+y^2} &\geq 2 \\ \implies x^2 + y^2 &\geq \ln 2 \end{aligned}$$

One way of describing the domain of this function is to call it “all points (x, y) with $x^2 + y^2 \geq \ln 2$.” A more standard way is to describe the *shape* this set makes in \mathbb{R}^2 : all points on or outside the circle centred at the origin with radius $\sqrt{\ln 2} \approx 0.83$.

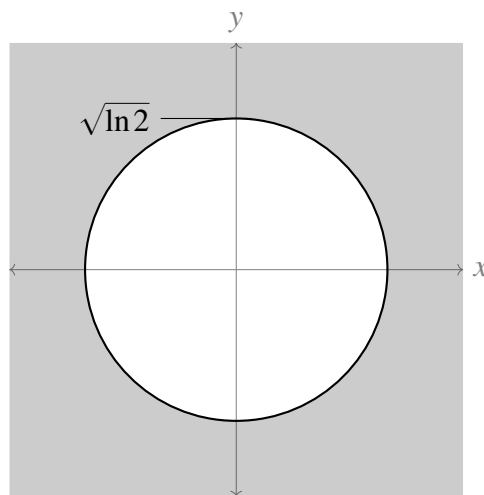

To help you visualize what we mean, take a point in the shaded area above. For example, $(1, .5)$. If we plug that into our function, it causes no problems:

$$f(1, .5) = \sqrt{e^{1^2+.5^2} - 2} = \sqrt{e^{1.25} - 2} \approx \sqrt{1.49} \approx 1.22$$

On the other hand, take a point in the white area. For example, $(.5, .5)$. If we try to plug this into our function, we end up with

$$f(.5, .5) = \sqrt{e^{.5^2+.5^2} - 2} = \sqrt{e^{0.5} - 2} \approx \sqrt{1.65 - 2} \approx \sqrt{-0.35}$$

which is not a real number.

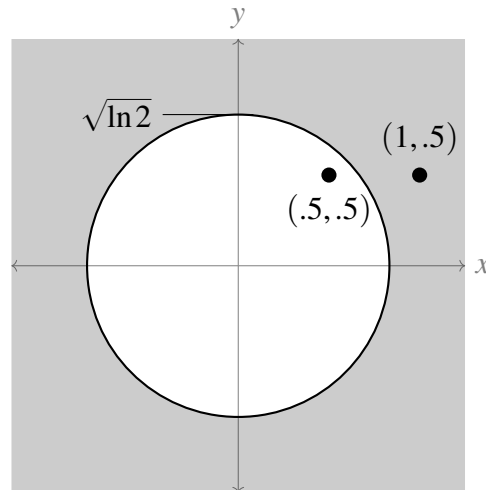

Now, let's think about range. By choosing larger and larger values of x and y , we can make $x^2 + y^2$ into larger and larger numbers. So within our restricted domain, the range of $x^2 + y^2$ is $[\ln 2, \infty)$; so the range of $e^{x^2+y^2}$ is $[e^{\ln 2}, \infty) = [2, \infty)$; so the range of $e^{x^2+y^2} - 2$ is $[0, \infty)$; so the range of $f(x,y)$ is $[0, \infty)$.

Again, note that the *domain* of f consists of ordered pairs of real numbers, while its *range* consists of real numbers.

Example 14.2.3

Example 14.2.4

Find the domain and range of the function

$$f(x,y) = \sin\left(\frac{x}{\sqrt{y}}\right)$$

Solution. Let's start with domain. We can take the sine of any number we like, so that part of the function doesn't limit the domain. The things limiting the domain are that we cannot take the square root of a negative number, and we can't divide by zero.

- Because we can't take the square root of a negative number, we must have $y \geq 0$.
- Because we can't divide by 0, we must have $\sqrt{y} \neq 0$, i.e. $y \neq 0$.

Combining these restrictions, we can only have values of y in the interval $(0, \infty)$; x can be any real number. So, our domain is the upper half of the xy plane, excluding the x -axis:

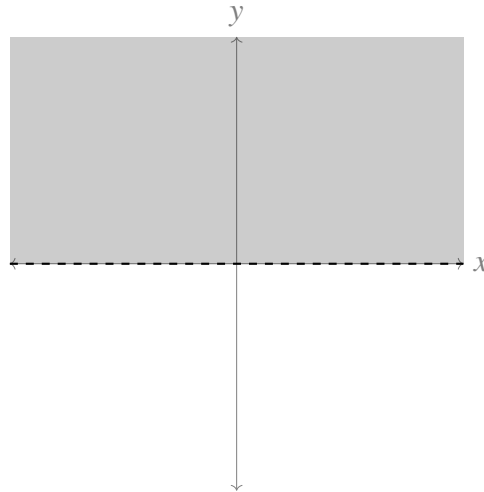

In general, the range of $\sin x$ is $[-1, 1]$. So, we certainly can't get a *larger* range than this. We should check that our range is no smaller. When $y = 1$, our function becomes $f(x, 1) = \sin(x/1) = \sin x$. Since x can be any real number, indeed the range of our function is $[-1, 1]$.

Example 14.2.4

Example 14.2.5

Find the domain and range of the function

$$f(x, y) = \ln(\arctan(x + y))$$

Solution. First, let's think about the arctangent and logarithm function in the context of single-variable functions. The domain of arctangent is all real numbers, and its range is $(-\frac{\pi}{2}, \frac{\pi}{2})$. The domain of the natural logarithm is all *positive* numbers, and its range is all real numbers.

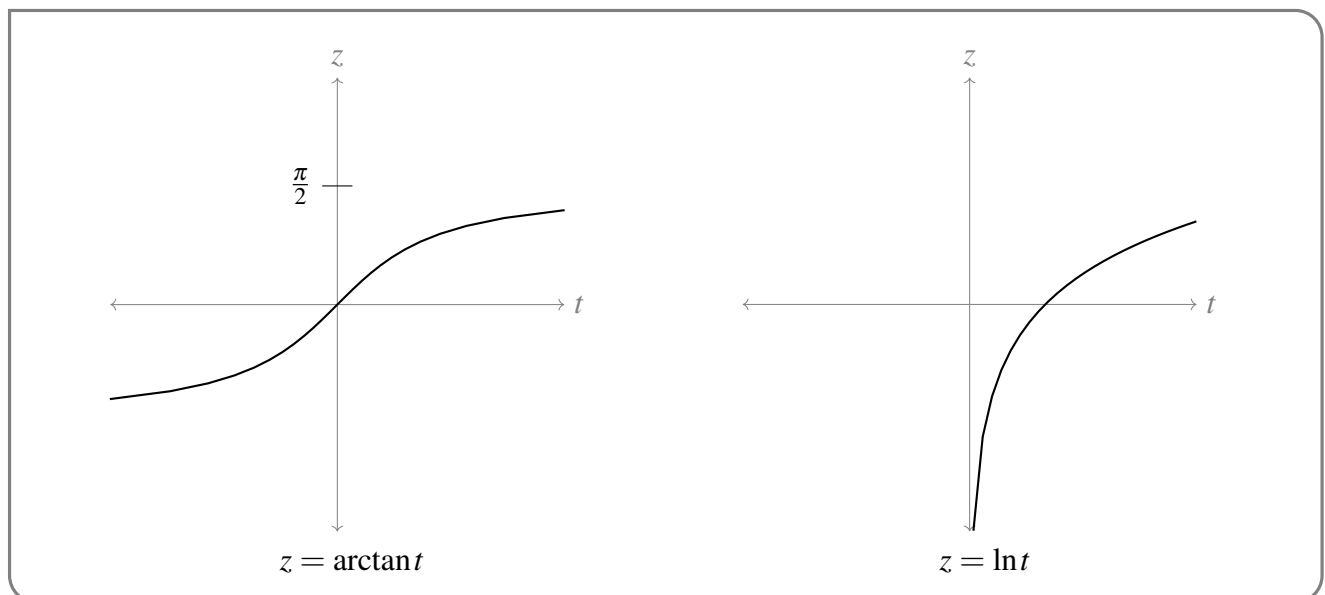

Since only positive numbers may be input into the natural logarithm, we require $\arctan(x+y) > 0$. That requires $(x+y) > 0$. So, our domain is the collection of all points (x,y) such that $x+y > 0$; put another way, all points above the line $y = -x$.

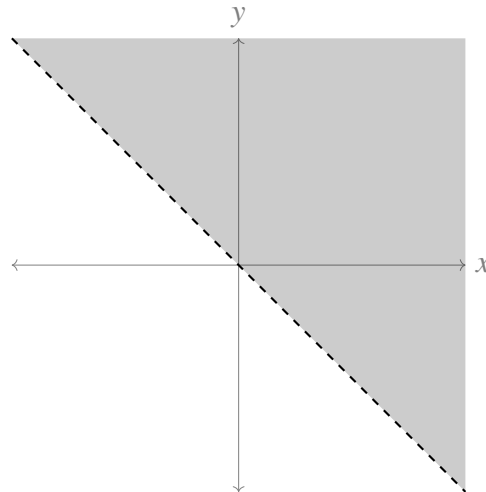

If our domain is points (x,y) such that $x+y > 0$, then the range of the function $(x+y)$ is $(0, \infty)$; so the numbers being plugged into the arctangent function are $(0, \infty)$. So, the numbers coming out of the arctangent function are $(0, \frac{\pi}{2})$. Then the numbers from $(0, \frac{\pi}{2})$ are being input into the natural logarithm function, leading to a range of the entire function of $(-\infty, \ln(\frac{\pi}{2}))$.

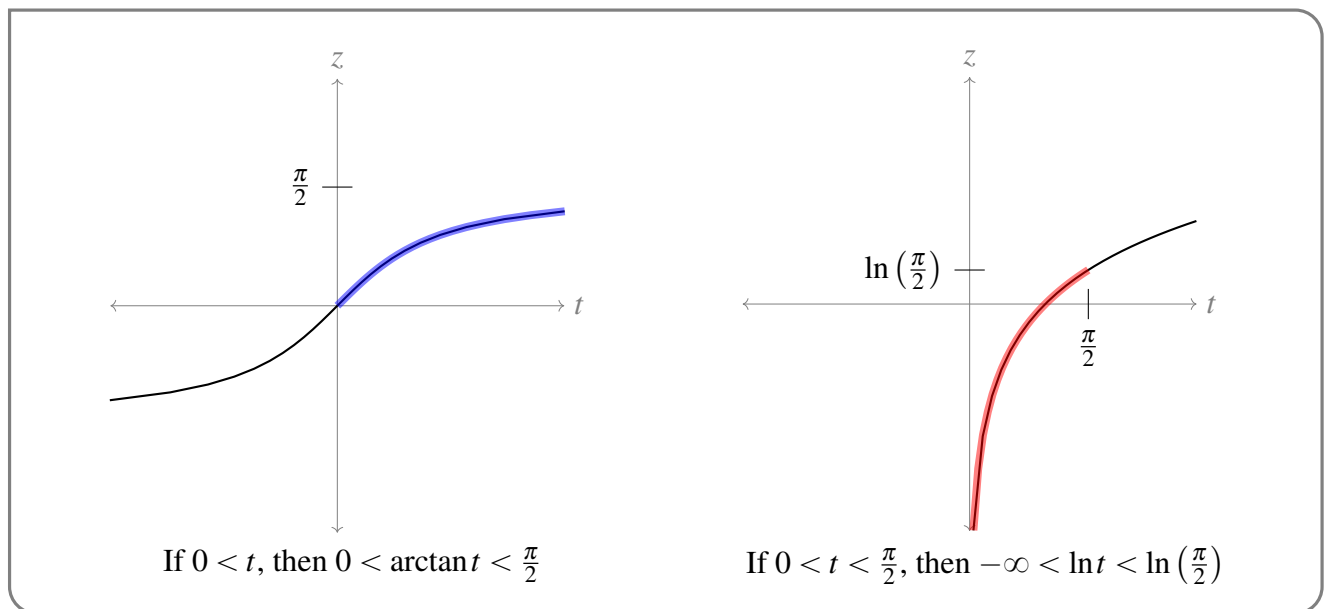

Example 14.2.5

We may sometimes restrict the domain of a function more than is mathematically necessary in order for it to make sense in a model. For example, we may have a function that only makes sense in our model when it gives positive values. In this case, we might restrict the domain to a *model*

domain, the set of inputs for which the function is not only defined, but sensible in the context of our model.

Example 14.2.6

A large pharmaceutical company determines its research budget for a new vaccine according to the formula

$$R(x,y) = \ln(xy)$$

where x is the size of the customer base they expect to have and y is the revenue they expect per dose.

Then for each variable x , y , and R , negative values don't make sense in the model. So although we *could* compute $R(-1, -1) = 1$, and we *could* compute $R(0.5, 0.5) \approx -1.39$, they wouldn't be sensible in the context of our model.

- Since x and y need to be nonnegative, we will only consider points (x,y) in the first quadrant of the Cartesian plane: $x \geq 0$ and $y \geq 0$.
- Since R needs to be nonnegative, we will further restrict $xy \geq 1$. That is, $y \geq \frac{1}{x}$.

The two restrictions above give us the model domain shaded below.

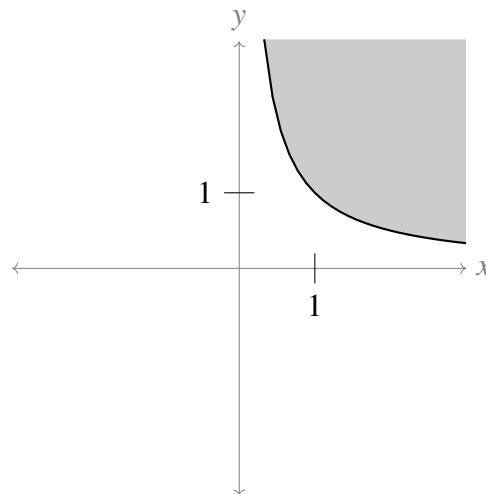

Depending on the specifics of how the function is being used, the model domain may be restricted even further. For example, perhaps the firm has a maximum budget for any given project; perhaps the amount they can charge is limited by law; etc.

Example 14.2.6

14.3 ▲ Sketching surfaces in 3D

Learning Objectives

In Math 100, you won't be asked to produce sketches of 3D surfaces, so there are no learning objectives associated with this section. However, you will be *shown* such sketches. Understanding how they can be produced can help you deepen and solidify your understanding of

the behaviour of multivariable functions.

In practice students taking multivariable calculus regularly have great difficulty visualising surfaces in three dimensions, despite the fact that we all live in three dimensions. We'll now develop some technique to help us sketch surfaces in three dimensions⁵.

We all have a fair bit of experience drawing curves in two dimensions. Typically the intersection of a surface (in three dimensions) with a plane is a curve lying in the (two dimensional) plane. Such an intersection is usually called a cross-section. In the special case that the plane is one of the coordinate planes, or parallel to one of the coordinate planes, the intersection is sometimes called a trace.

Definition 14.3.1.

The trace of a surface is the intersection of that surface with a plane that is parallel to one of the coordinate planes.

So, one trace (the intersection with the xy plane) is found by setting z equal to a constant; another trace (the intersection with the yz plane) is found by setting x equal to a constant; and the final trace (the intersection with the xz plane) is found by setting y equal to a constant.

One can often get a pretty good idea of what a surface looks like by sketching a bunch of cross-sections. Here are some examples.

Example 14.3.2 ($4x^2 + y^2 - z^2 = 1$)

Sketch the surface that satisfies $4x^2 + y^2 - z^2 = 1$.

Solution. We'll start by fixing any number z_0 and sketching the part of the surface that lies in the horizontal plane $z = z_0$.

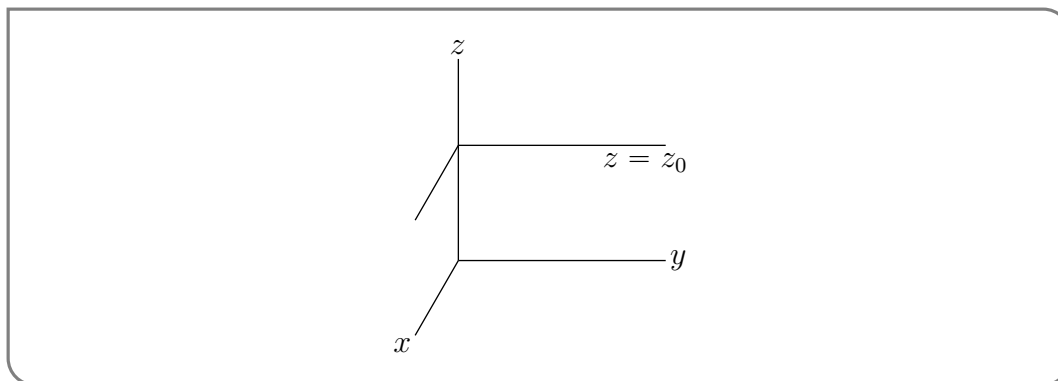

The intersection of our surface with that horizontal plane is a horizontal cross-section. Any point (x, y, z) lying on that horizontal cross-section satisfies both

$$\begin{aligned} z = z_0 \quad \text{and} \quad 4x^2 + y^2 - z^2 = 1 \\ \iff z = z_0 \quad \text{and} \quad 4x^2 + y^2 = 1 + z_0^2 \end{aligned}$$

5 Of course you could instead use some fancy graphing software, but part of the point is to build intuition. Not to mention that you can't use fancy graphing software on your exam.

Think of z_0 as a constant. Then $4x^2 + y^2 = 1 + z_0^2$ is a curve in the xy -plane. As $1 + z_0^2$ is a constant, the curve is an ellipse. To determine its semi-axes⁶, we observe that when $y = 0$, we have $x = \pm \frac{1}{2}\sqrt{1 + z_0^2}$ and when $x = 0$, we have $y = \pm\sqrt{1 + z_0^2}$. So the curve is just an ellipse with x semi-axis $\frac{1}{2}\sqrt{1 + z_0^2}$ and y semi-axis $\sqrt{1 + z_0^2}$. It's easy to sketch.

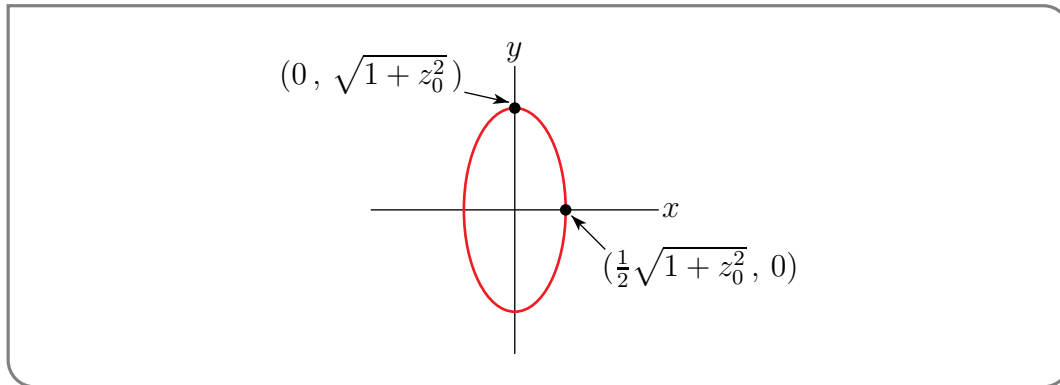

Remember that this ellipse is the part of our surface that lies in the plane $z = z_0$. Imagine that the sketch of the ellipse is on a single sheet of paper. Lift the sheet of paper up, move it around so that the x - and y -axes point in the directions of the three dimensional x - and y -axes and place the sheet of paper into the three dimensional sketch at height z_0 . This gives a single horizontal ellipse in 3d, as in the figure below.

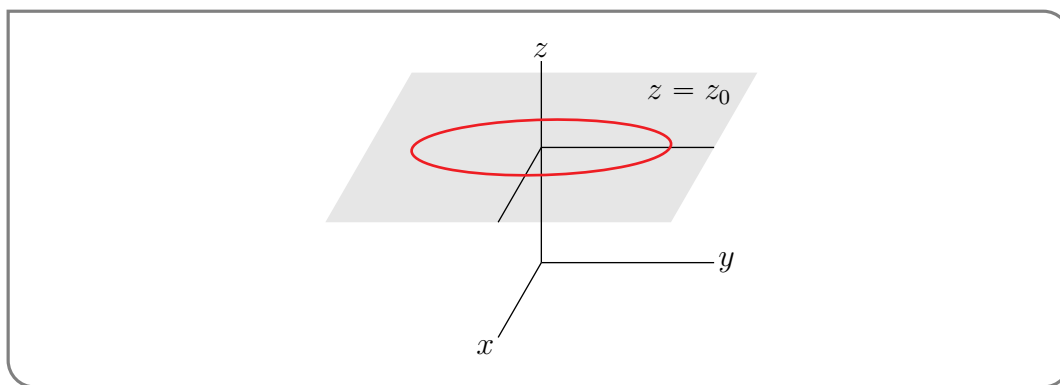

We can build up the full surface by stacking many of these horizontal ellipses — one for each possible height z_0 . So we now draw a few of them as in the figure below. To reduce the amount of clutter in the sketch, we have only drawn the first octant (i.e. the part of three dimensions that has $x \geq 0$, $y \geq 0$ and $z \geq 0$).

6 The semi-axes of an ellipse are the line segments from the centre of the ellipse to the farthest point on the curve and to the nearest point on the curve. For a circle the lengths of both of these line segments are just the radius.

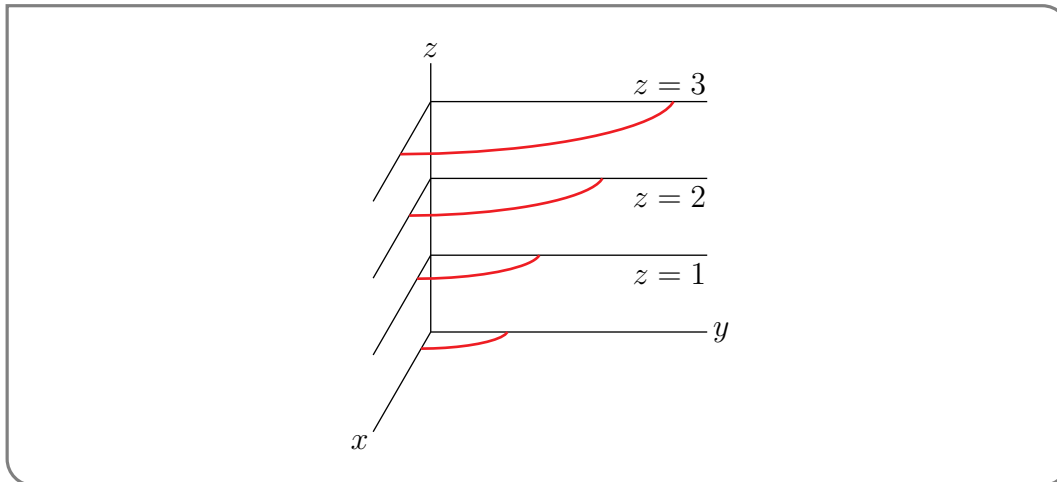

Here is why it is OK, in this case, to just sketch the first octant. Replacing x by $-x$ in the equation $4x^2 + y^2 - z^2 = 1$ does not change the equation. That means that a point (x, y, z) is on the surface if and only if the point $(-x, y, z)$ is on the surface. So the surface is invariant under reflection in the yz -plane. Similarly, the equation $4x^2 + y^2 - z^2 = 1$ does not change when y is replaced by $-y$ or z is replaced by $-z$. Our surface is also invariant under reflection in the xz - and xy -planes. Once we have the part in the first octant, the remaining octants can be gotten simply by reflecting about the coordinate planes.

We can get a more visually meaningful sketch by adding in some vertical cross-sections. The $x = 0$ and $y = 0$ cross-sections (also called traces — they are the parts of our surface that are in the yz - and xz -planes, respectively) are

$$x = 0, y^2 - z^2 = 1 \quad \text{and} \quad y = 0, 4x^2 - z^2 = 1$$

These equations describe hyperbolae⁷. If you don't remember how to sketch them, don't worry. We'll do it now. We'll first sketch them in 2d. Since

$$\begin{aligned} y^2 = 1 + z^2 &\implies |y| \geq 1 \quad \text{and} \quad y = \pm 1 \text{ when } z = 0 \quad \text{and} \quad \text{for large } z, y \approx \pm z \\ 4x^2 = 1 + z^2 &\implies |x| \geq \frac{1}{2} \quad \text{and} \quad x = \pm \frac{1}{2} \text{ when } z = 0 \quad \text{and} \quad \text{for large } z, x \approx \pm \frac{1}{2}z \end{aligned}$$

the sketches are

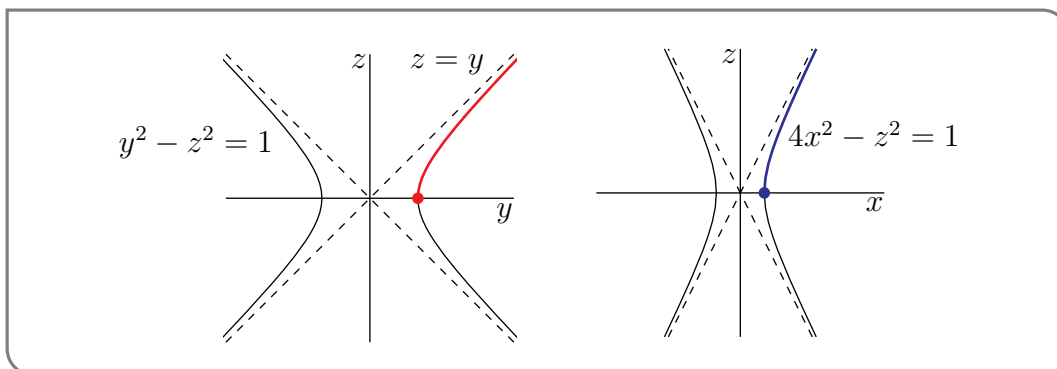

Now we'll incorporate them into the 3d sketch. Once again imagine that each is a single sheet of paper. Pick each up and move it into the 3d sketch, carefully matching up the axes. The red (blue) parts of the hyperbolas above become the red (blue) parts of the 3d sketch below (assuming of course that you are looking at this on a colour screen).

7 It's not just a figure of speech!

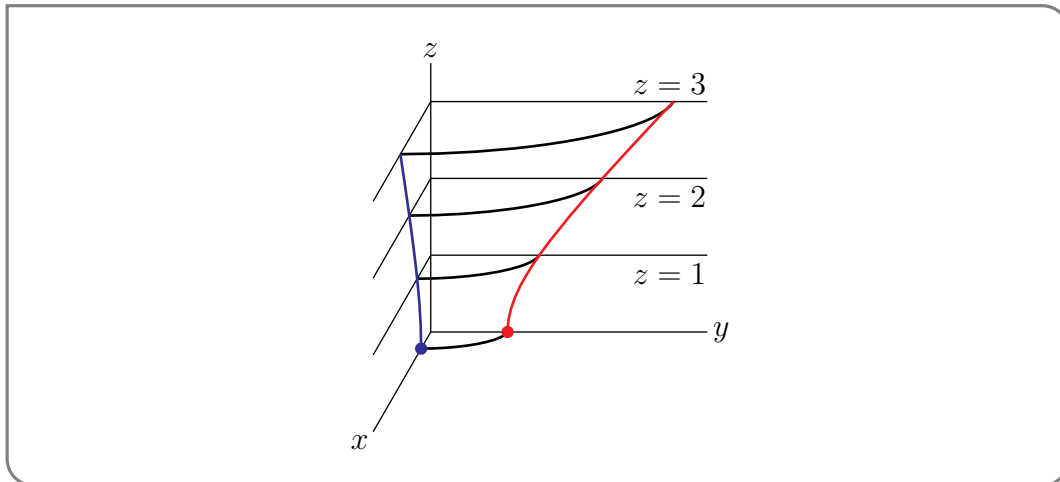

Now that we have a pretty good idea of what the surface looks like we can clean up and simplify the sketch. Here are a couple of possibilities.

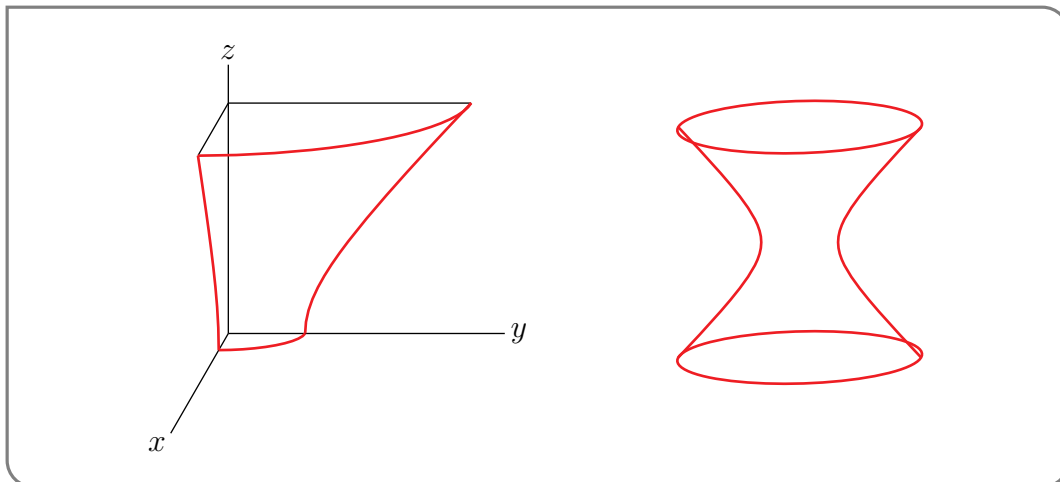

This type of surface is called a hyperboloid of one sheet.

There are also hyperboloids of two sheets. For example, replacing the $+1$ on the right hand side of $x^2 + y^2 - z^2 = 1$ gives $x^2 + y^2 - z^2 = -1$, which is a hyperboloid of two sheets. We'll sketch it quickly in the next example.

Example 14.3.2

Example 14.3.3 ($4x^2 + y^2 - z^2 = -1$)

Sketch the surface that satisfies $4x^2 + y^2 - z^2 = -1$.

Solution. As in the last example, we'll start by fixing any number z_0 and sketching the part of the surface that lies in the horizontal plane $z = z_0$. The intersection of our surface with that horizontal plane is

$$z = z_0 \text{ and } 4x^2 + y^2 = z_0^2 - 1$$

Think of z_0 as a constant.

- If $|z_0| < 1$, then $z_0^2 - 1 < 0$ and there are no solutions to $x^2 + y^2 = z_0^2 - 1$.
- If $|z_0| = 1$ there is exactly one solution, namely $x = y = 0$.
- If $|z_0| > 1$ then $4x^2 + y^2 = z_0^2 - 1$ is an ellipse with x semi-axis $\frac{1}{2}\sqrt{z_0^2 - 1}$ and y semi-axis $\sqrt{z_0^2 - 1}$. These semi-axes are small when $|z_0|$ is close to 1 and grow as $|z_0|$ increases.

The first octant parts of a few of these horizontal cross-sections are drawn in the figure below.

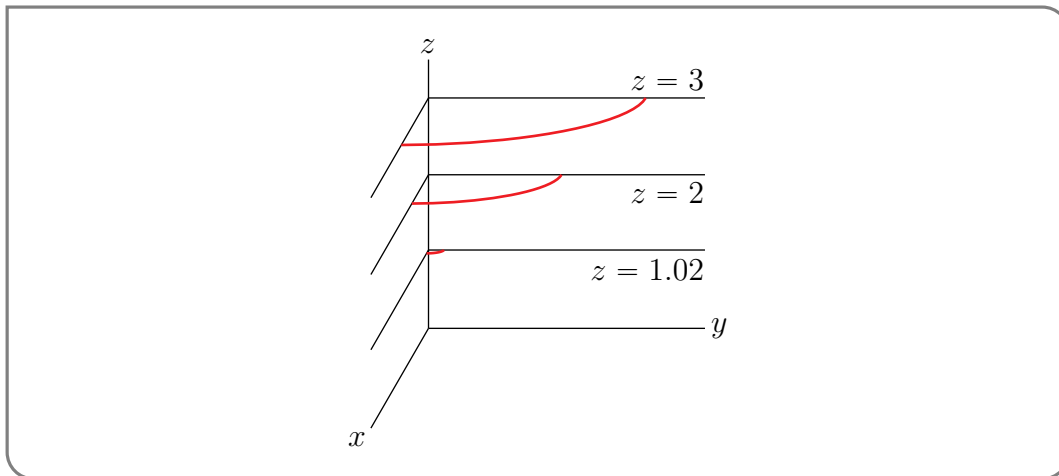

Next we add in the $x = 0$ and $y = 0$ cross-sections (i.e. the parts of our surface that are in the yz - and xz -planes, respectively)

$$x = 0, z^2 = 1 + y^2 \quad \text{and} \quad y = 0, z^2 = 1 + 4x^2$$

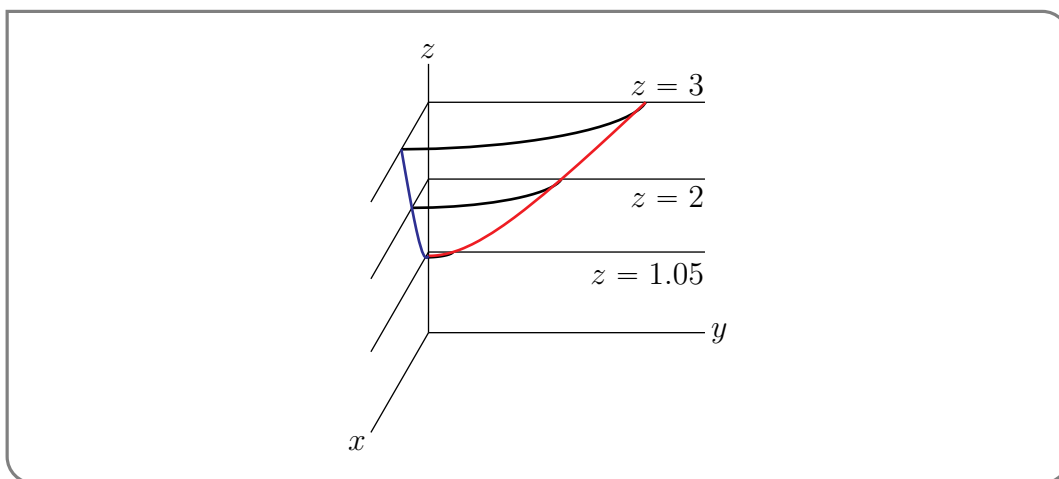

Now that we have a pretty good idea of what the surface looks like we clean up and simplify the sketch.

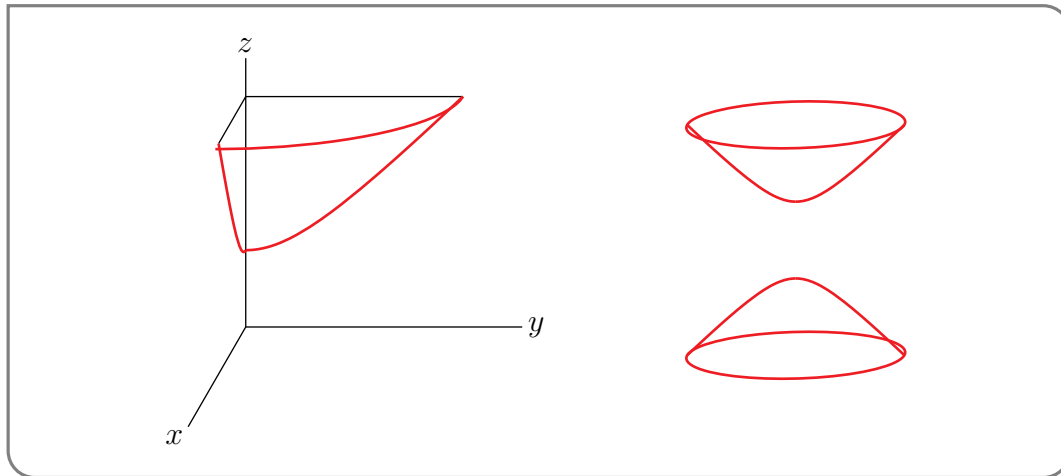

This type of surface is called a hyperboloid of two sheets.

Example 14.3.3

Example 14.3.4 ($yz = 1$)

Sketch the surface $yz = 1$.

Solution. This surface has a special property that makes it relatively easy to sketch. There are no x 's in the equation $yz = 1$. That means that if some y_0 and z_0 obey $y_0z_0 = 1$, then the point (x, y_0, z_0) lies on the surface $yz = 1$ for all values of x . As x runs from $-\infty$ to ∞ , the point (x, y_0, z_0) sweeps out a straight line parallel to the x -axis. So the surface $yz = 1$ is a union of lines parallel to the x -axis. It is invariant under translations parallel to the x -axis. To sketch $yz = 1$, we just need to sketch its intersection with the yz -plane and then translate the resulting curve parallel to the x -axis to sweep out the surface.

We'll start with a sketch of the hyperbola $yz = 1$ in two dimensions.

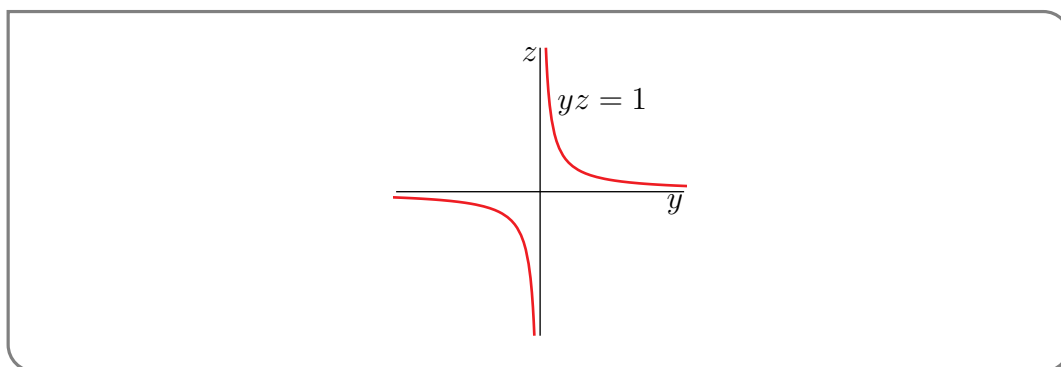

Next we'll move this 2d sketch into the yz -plane, i.e. the plane $x = 0$, in 3d, except that we'll only draw in the part in the first octant.

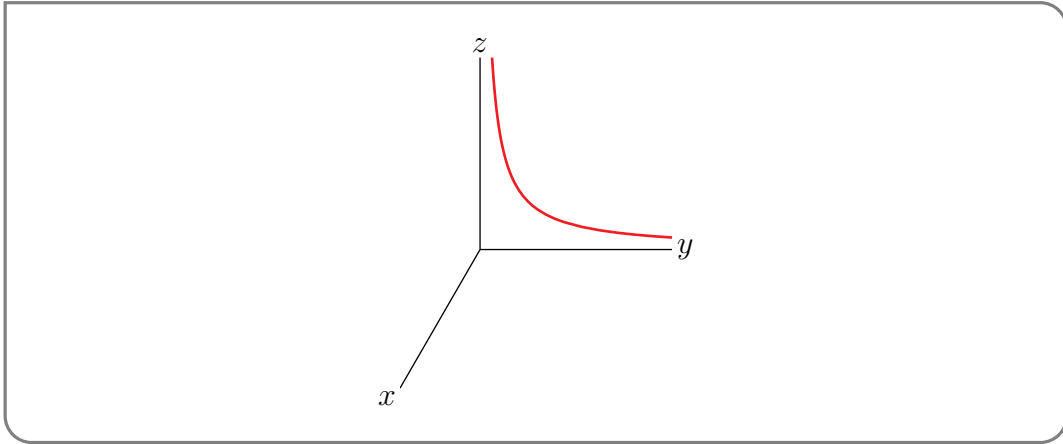

The we'll draw in $x = x_0$ cross-sections for a couple of more values of x_0

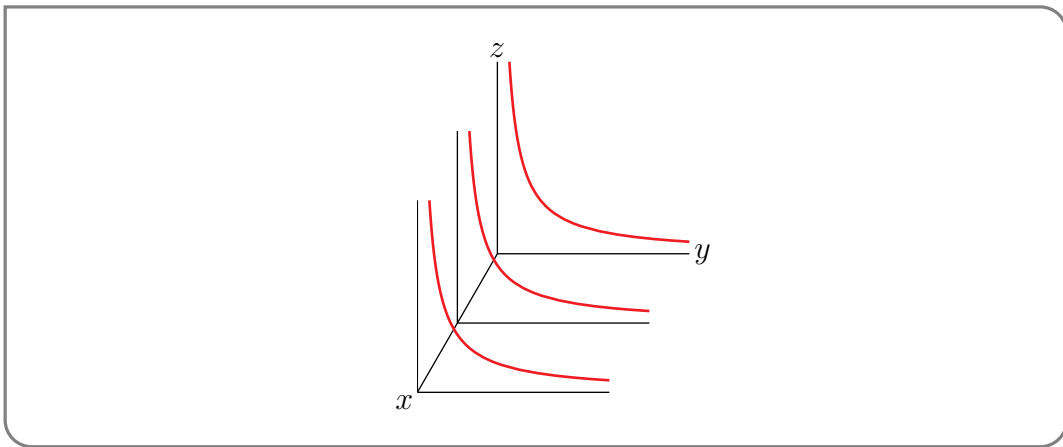

and clean up the sketch a bit

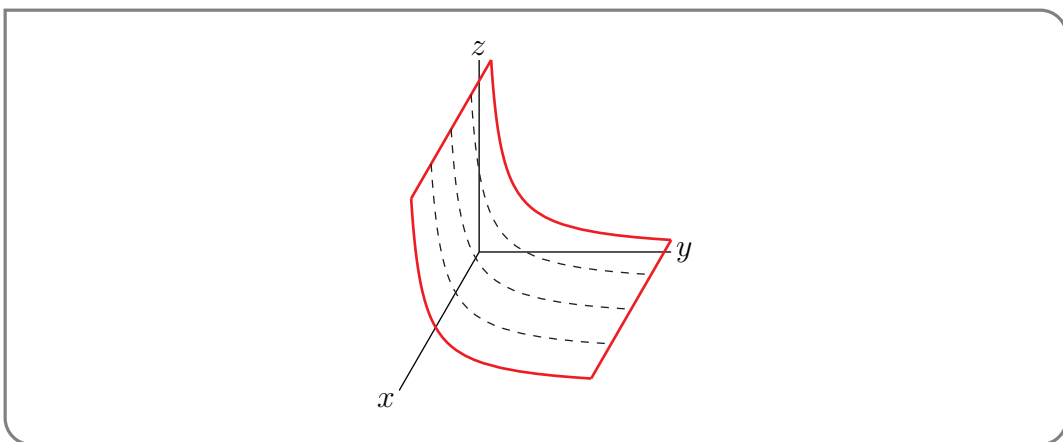

Example 14.3.4

Example 14.3.5 ($xyz = 4$)
 Sketch the surface $xyz = 4$.

Solution. We'll sketch this surface using much the same procedure as we used in Examples 14.3.2 and 14.3.3. We'll only sketch the part of the surface in the first octant. The remaining parts (in the octants with $x, y < 0, z \geq 0$, with $x, z < 0, y \geq 0$ and with $y, z < 0, x \geq 0$) are just reflections of the first octant part.

As usual, we start by fixing any number z_0 and sketching the part of the surface that lies in the horizontal plane $z = z_0$. The intersection of our surface with that horizontal plane is the hyperbola

$$z = z_0 \quad \text{and} \quad xy = \frac{4}{z_0}$$

Note that $x \rightarrow \infty$ as $y \rightarrow 0$ and that $y \rightarrow \infty$ as $x \rightarrow 0$. So the hyperbola has both the x -axis and the y -axis as asymptotes, when drawn in the xy -plane. The first octant parts of a few of these horizontal cross-sections (namely, $z_0 = 4$, $z_0 = 2$ and $z_0 = \frac{1}{2}$) are drawn in the figure below.

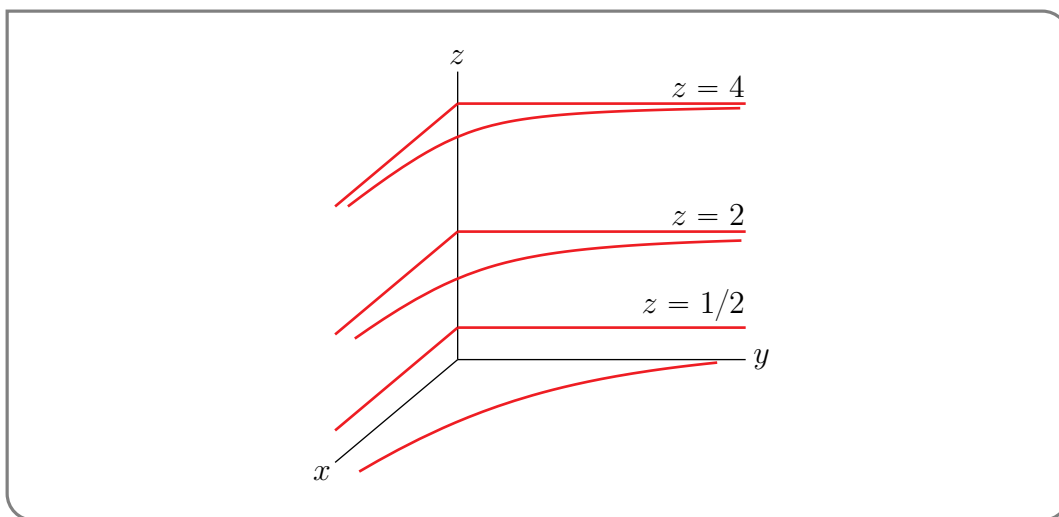

Next we add some vertical cross-sections. We can't use $x = 0$ or $y = 0$ because any point on $xyz = 4$ must have all of x, y, z nonzero. So we use

$$x = 4, yz = 1 \quad \text{and} \quad y = 4, xz = 1$$

instead. They are again hyperbolae.

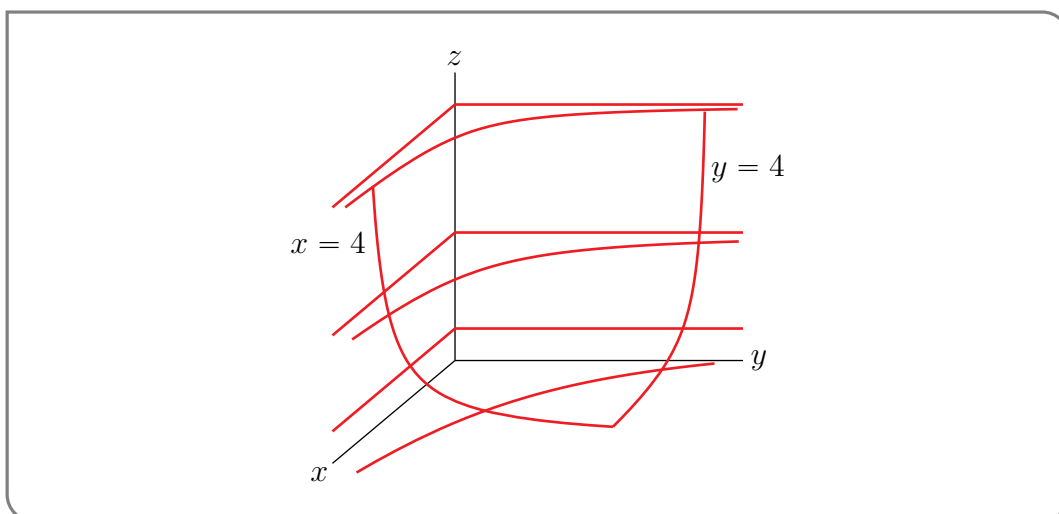

Finally, we clean up and simplify the sketch.

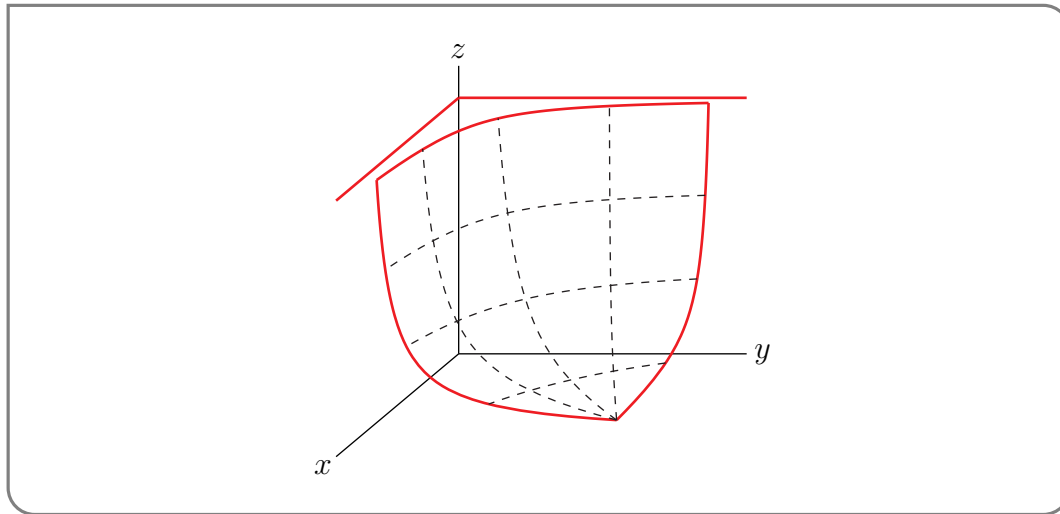

Example 14.3.5

Often the reason you are interested in a surface in 3d is that it is the graph $z = f(x, y)$ of a function of two variables $f(x, y)$. Another good way to visualize the behaviour of a function $f(x, y)$ is to sketch what are called its level curves.

Definition 14.3.6.

A level curve of $f(x, y)$ is a curve whose equation is $f(x, y) = C$, for some constant C .

A level curve is the set of points in the xy -plane where f takes the value C . Because it is a curve in 2d, it is usually easier to sketch than the graph of f . Here are a couple of examples.

Example 14.3.7 ($f(x, y) = x^2 + 4y^2 - 2x + 2$)

Sketch the level curves of $f(x, y) = x^2 + 4y^2 - 2x + 2$.

Solution. Fix any real number C . Then, for the specified function f , the level curve $f(x, y) = C$ is the set of points (x, y) that obey

$$\begin{aligned} x^2 + 4y^2 - 2x + 2 = C &\iff x^2 - 2x + 1 + 4y^2 + 1 = C \\ &\iff (x - 1)^2 + 4y^2 = C - 1 \end{aligned}$$

Now $(x - 1)^2 + 4y^2$ is the sum of two squares, and so is always at least zero. So if $C - 1 < 0$, i.e. if $C < 1$, there is no curve $f(x, y) = C$. If $C - 1 = 0$, i.e. if $C = 1$, then $f(x, y) = C - 1 = 0$ if and only if both $(x - 1)^2 = 0$ and $4y^2 = 0$ and so the level curve consists of the single point $(1, 0)$. If $C > 1$, then $f(x, y) = C$ become $(x - 1)^2 + 4y^2 = C - 1 > 0$ which describes an ellipse centred on $(1, 0)$. It intersects the x -axis when $y = 0$ and

$$(x - 1)^2 = C - 1 \iff x - 1 = \pm\sqrt{C - 1} \iff x = 1 \pm \sqrt{C - 1}$$

and it intersects the line $x = 1$ (i.e. the vertical line through the centre) when

$$4y^2 = C - 1 \iff 2y = \pm\sqrt{C-1} \iff y = \pm\frac{1}{2}\sqrt{C-1}$$

So, when $C > 1$, $f(x, y) = C$ is the ellipse centred on $(1, 0)$ with x semi-axis $\sqrt{C-1}$ and y semi-axis $\frac{1}{2}\sqrt{C-1}$. Here is a sketch of some representative level curves of $f(x, y) = x^2 + 4y^2 - 2x + 2$.

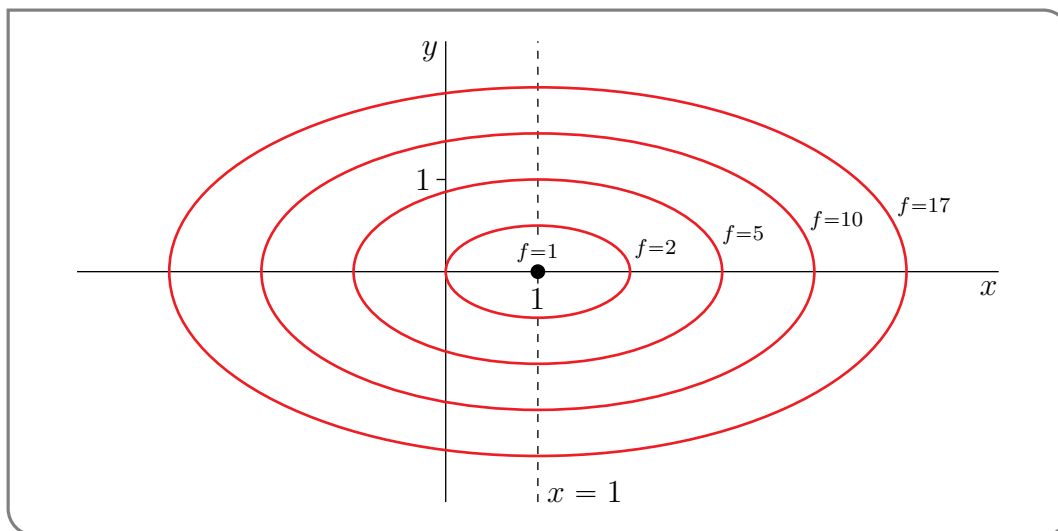

It is often easier to develop an understanding of the behaviour of a function $f(x, y)$ by looking at a sketch of its level curves, than it is by looking at a sketch of its graph. On the other hand, you can also use a sketch of the level curves of $f(x, y)$ as the first step in building a sketch of the graph $z = f(x, y)$. The next step would be to redraw, for each C , the level curve $f(x, y) = C$, in the plane $z = C$, as we did in Example 14.3.2.

Example 14.3.7

If you've ever used a topographic map, you've seen examples of level curves. Modelling the z -axis as a measure of elevation, with $z = 0$ as sea level, the contours shown on topographic maps show the level curves associated with different elevations. The example⁸ below shows the area around Gambier, Anvil, and Keats Islands, north of UBC. The lines show level curves for $z = 0$ metres, $z = 100$ metres, $z = 200$ metres, etc.

8 generated by Natural Resources Canada's [Atlas of Canada - Toporama](#), included under an [open government license](#)



Example 14.3.8 ($e^{x+y+z} = 1$)

The function $f(x,y)$ is given implicitly by the equation $e^{x+y+z} = 1$. Sketch the level curves of f .

Solution. This one is not as nasty as it appears. That “ $f(x,y)$ is given implicitly by the equation $e^{x+y+z} = 1$ ” means that, for each x,y , the solution z of $e^{x+y+z} = 1$ is $f(x,y)$. So, for the specified function f and any fixed real number C , the level curve $f(x,y) = C$ is the set of points (x,y) that obey

$$e^{x+y+C} = 1 \iff x + y + C = 0 \quad (\text{by taking the ln of both sides})$$

$$\iff x + y = -C$$

This is of course a straight line. It intersects the x -axis when $y = 0$ and $x = -C$ and it intersects the y -axis when $x = 0$ and $y = -C$. Here is a sketch of some level curves.

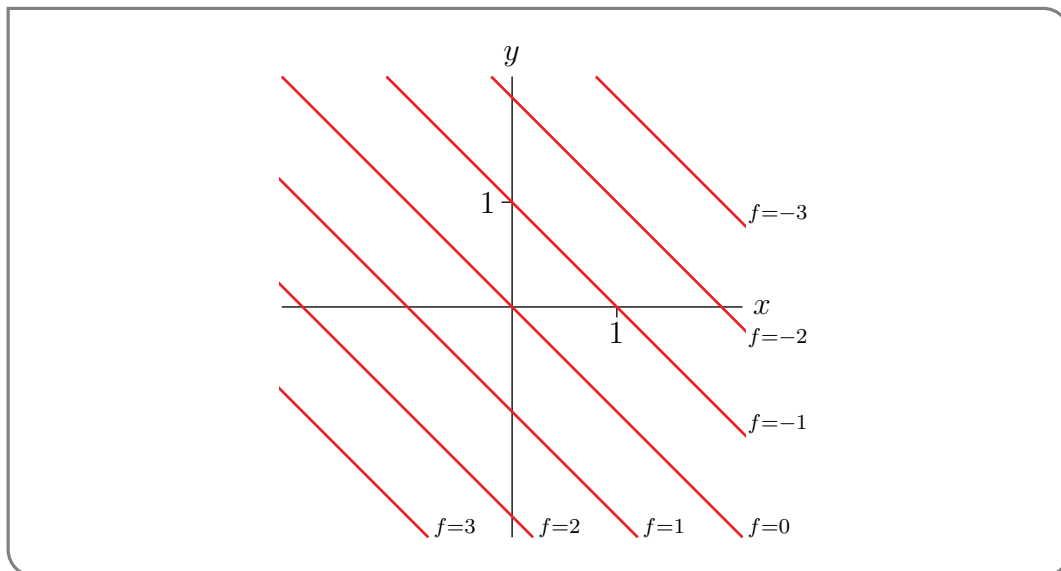

Example 14.3.8

We have just seen that sketching the level curves of a function $f(x, y)$ can help us understand the behaviour of f . We can generalise this to functions $F(x, y, z)$ of three variables. A level surface of $F(x, y, z)$ is a surface whose equation is of the form $F(x, y, z) = C$ for some constant C . It is the set of points (x, y, z) at which F takes the value C .

 Example 14.3.9 ($F(x, y, z) = x^2 + y^2 + z^2$)

Let $F(x, y, z) = x^2 + y^2 + z^2$. If $C > 0$, then the level surface $F(x, y, z) = C$ is the sphere of radius \sqrt{C} centred on the origin. Here is a sketch of the parts of the level surfaces $F = 1$ (radius 1), $F = 4$ (radius 2) and $F = 9$ (radius 3) that are in the first octant.

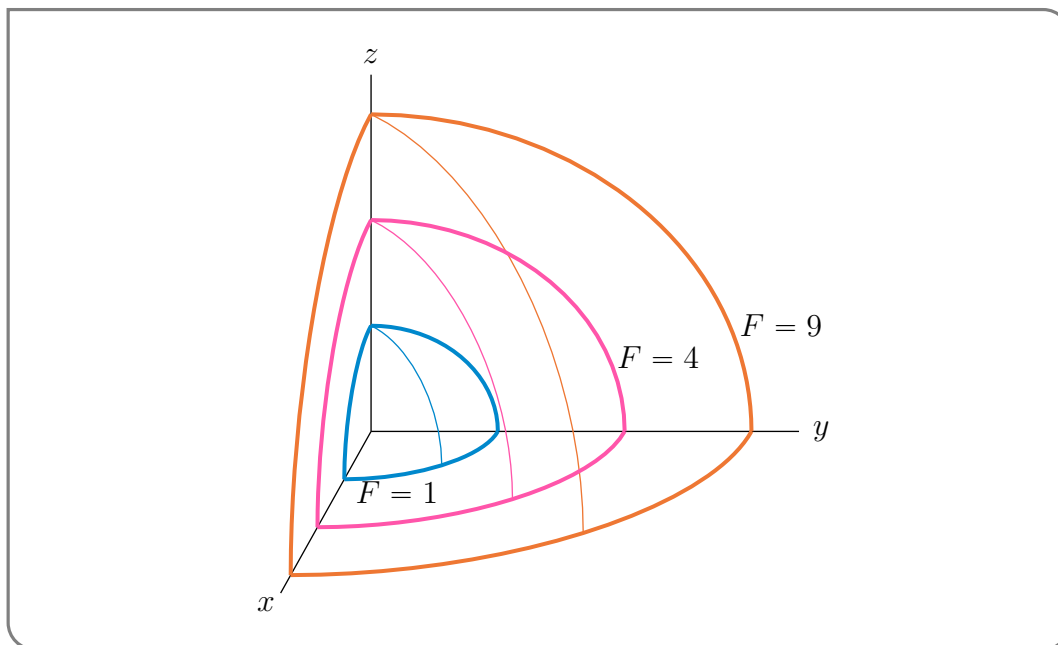

Example 14.3.9

 Example 14.3.10 ($F(x, y, z) = x^2 + z^2$)

Let $F(x, y, z) = x^2 + z^2$ and $C > 0$. Consider the level surface $x^2 + z^2 = C$. The variable y does not appear in this equation. So for any fixed y_0 , the intersection of the our surface $x^2 + z^2 = C$ with the plane $y = y_0$ is the circle of radius \sqrt{C} centred on $x = z = 0$. Here is a sketch of the first quadrant part of one such circle.

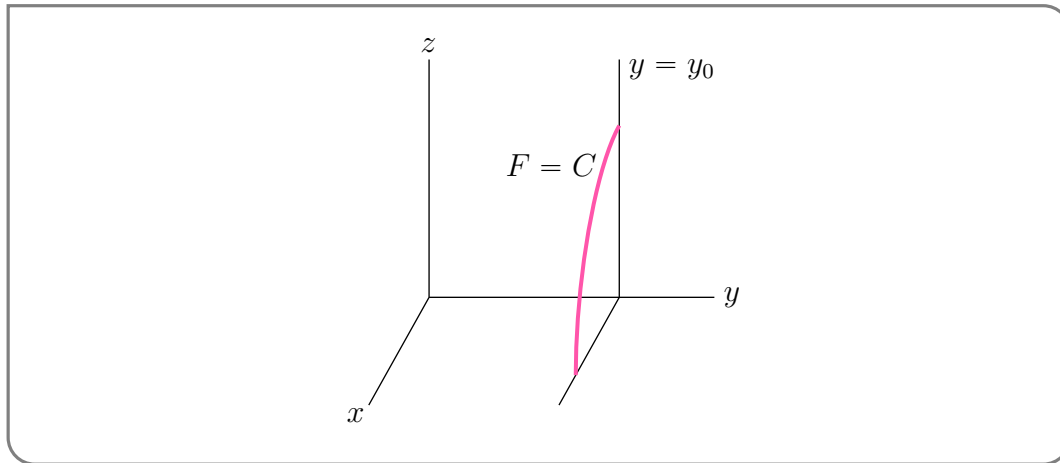

The full surface is the horizontal stack of all of those circles with y_0 running over \mathbb{R} . It is the cylinder of radius \sqrt{C} centred on the y -axis. Here is a sketch of the parts of the level surfaces $F = 1$ (radius 1), $F = 4$ (radius 2) and $F = 9$ (radius 3) that are in the first octant.

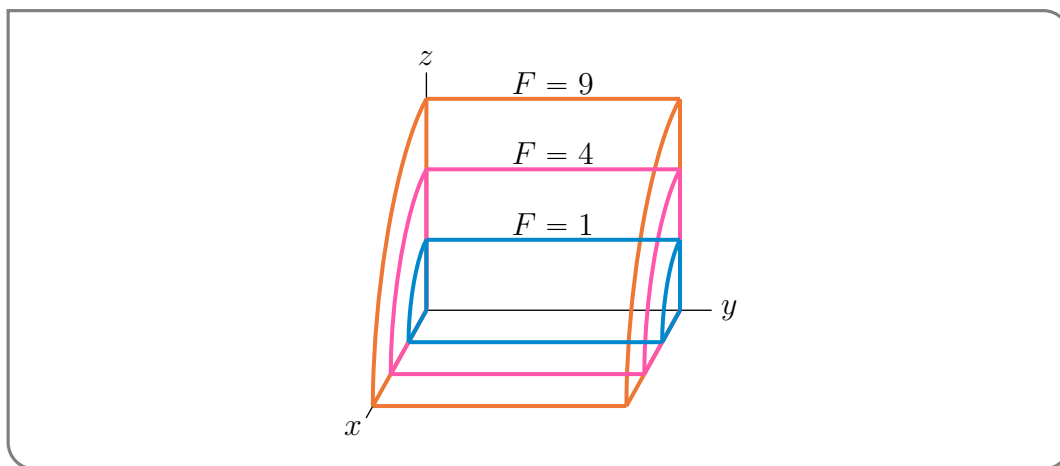

Example 14.3.10

Example 14.3.11 ($F(x,y,z) = e^{x+y+z}$)

Let $F(x,y,z) = e^{x+y+z}$ and $C > 0$. Consider the level surface $e^{x+y+z} = C$, or equivalently, $x + y + z = \ln C$. It is the plane that contains the intercepts $(\ln C, 0, 0)$, $(0, \ln C, 0)$ and $(0, 0, \ln C)$. Here is a sketch of the parts of the level surfaces

- $F = e$ (intercepts $(1, 0, 0)$, $(0, 1, 0)$, $(0, 0, 1)$),
- $F = e^2$ (intercepts $(2, 0, 0)$, $(0, 2, 0)$, $(0, 0, 2)$) and
- $F = e^3$ (intercepts $(3, 0, 0)$, $(0, 3, 0)$, $(0, 0, 3)$)

that are in the first octant.

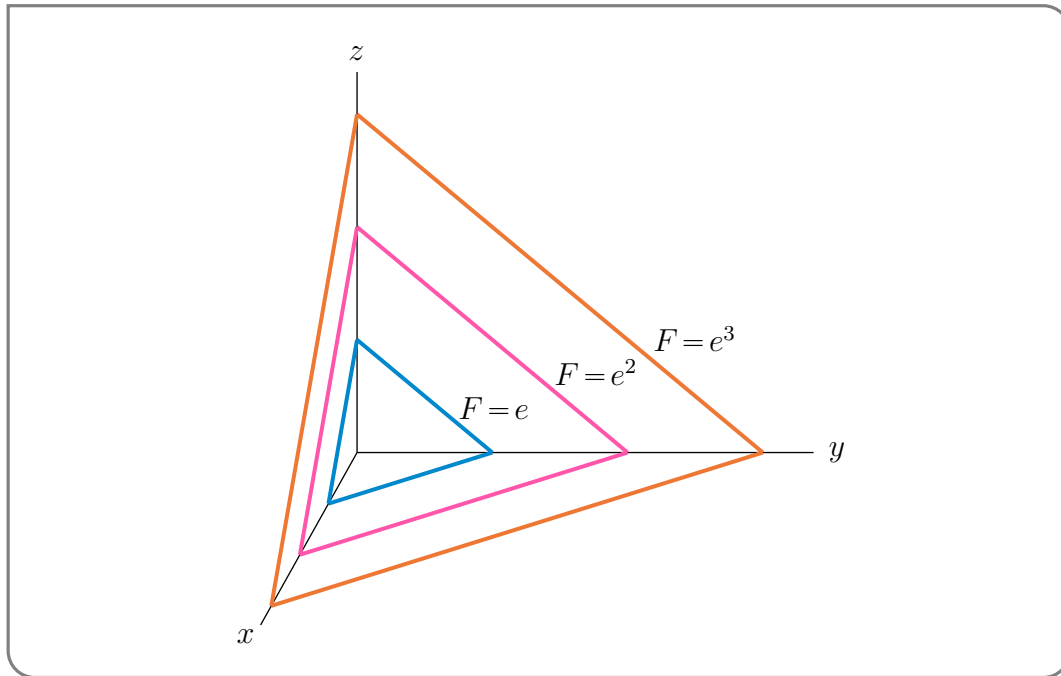

Example 14.3.11

There some classes of relatively simple, but commonly occurring, surfaces that are given their own names. One such class is cylindrical surfaces. You are probably used to thinking of a cylinder as being something that looks like $x^2 + y^2 = 1$.

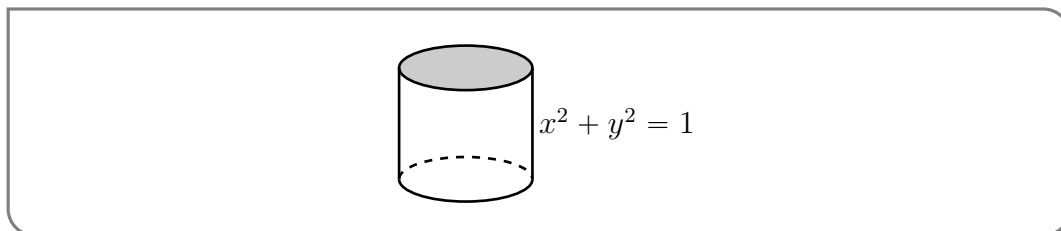

In Mathematics the word “cylinder” is given a more general meaning.

Definition 14.3.12 (Cylinder).

A *cylinder* is a surface that consists of all points that are on all lines that are

- parallel to a given line and
- pass through a given fixed plane curve (in a plane not parallel to the given line).

Example 14.3.13

Here are sketches of three cylinders. The familiar cylinder on the left below

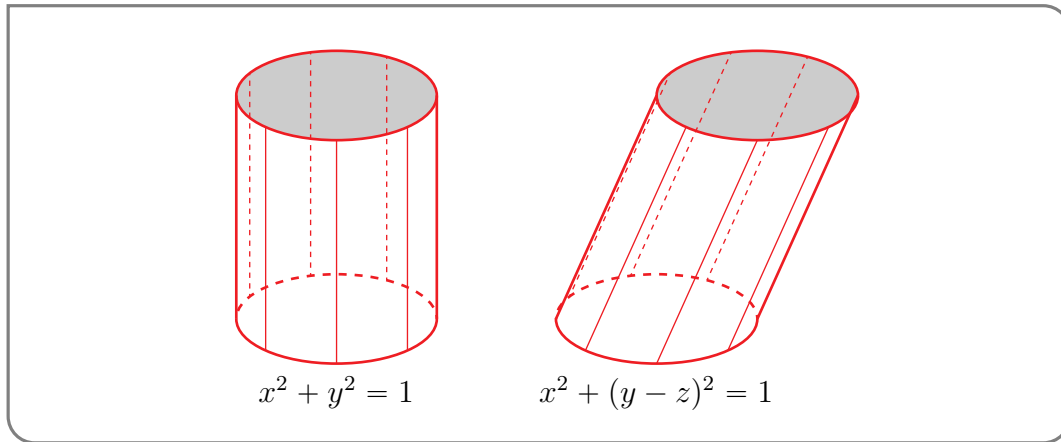

is called a right circular cylinder, because the given fixed plane curve ($x^2 + y^2 = 1, z = 0$) is a circle and the given line (the z -axis) is perpendicular (i.e. at right angles) to the fixed plane curve.

The cylinder on the left above can be thought of as a vertical stack of circles. The cylinder on the right above can also be thought of as a stack of circles, but the centre of the circle at height z has been shifted rightward to $(0, z, z)$. For that cylinder, the given fixed plane curve is once again the circle $x^2 + y^2 = 1, z = 0$, but the given line is $y = z, x = 0$.

We have already seen the third cylinder

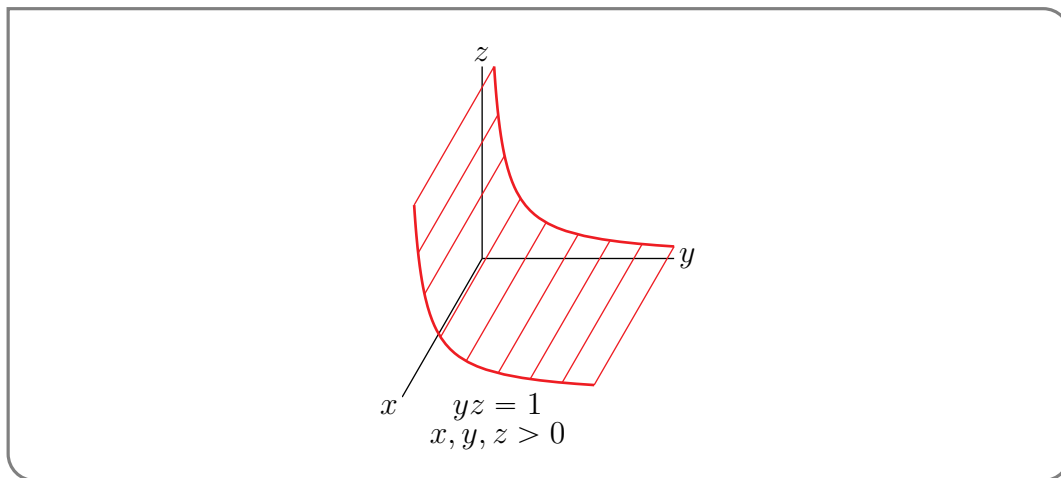

in Example 14.3.4. It is called a hyperbolic cylinder. In this example, the given fixed plane curve is the hyperbola $yz = 1, x = 0$ and the given line is the x -axis.

Example 14.3.13

►► **Quadric Surfaces**

Another named class of relatively simple, but commonly occurring, surfaces is the quadric surfaces.

Definition 14.3.14 (Quadrics).

A *quadric* surface is surface that consists of all points that obey $Q(x, y, z) = 0$, with Q being a polynomial of degree two⁹.

For $Q(x, y, z)$ to be a polynomial of degree two, it must be of the form

$$Q(x, y, z) = Ax^2 + By^2 + Cz^2 + Dxy + Eyz + Fxz + Gx + Hy + Iz + J$$

for some constants A, B, \dots, J . Each constant z cross section of a quadric surface has an equation of the form

$$Ax^2 + Dxy + By^2 + gx + hy + j = 0, \quad z = z_0$$

If $A = B = D = 0$ but g and h are not both zero, this is a straight line. If A, B , and D are not all zero, then by rotating and translating our coordinate system the equation of the cross section can be brought into one of the forms¹⁰

- $\alpha x^2 + \beta y^2 = \gamma$ with $\alpha, \beta > 0$, which, if $\gamma > 0$, is an ellipse (or a circle),
- $\alpha x^2 - \beta y^2 = \gamma$ with $\alpha, \beta > 0$, which, if $\gamma \neq 0$, is a hyperbola, and if $\gamma = 0$ is two lines,
- $x^2 = \delta y$, which, if $\delta \neq 0$ is a parabola, and if $\delta = 0$ is a straight line.

There are similar statements for the constant y cross sections and the constant z cross sections. Hence quadratic surfaces are built by stacking these three types of curves.

We have already seen a number of quadric surfaces in the last couple of sections.

- We saw the quadric surface $4x^2 + y^2 - z^2 = 1$ in Example 14.3.2.

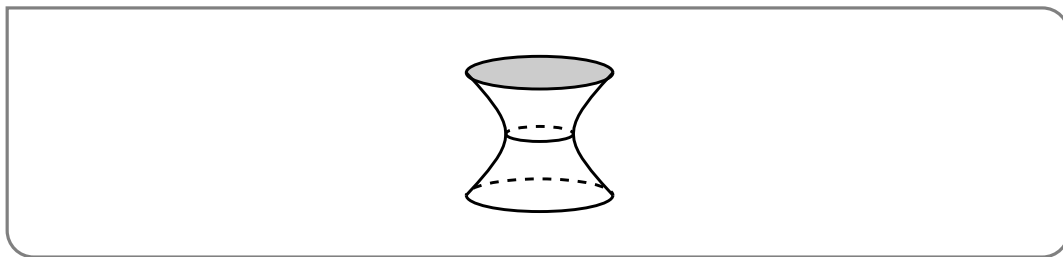

Its constant z cross sections are ellipses and its $x = 0$ and $y = 0$ cross sections are hyperbolae. It is called a hyperboloid of one sheet.

- We saw the quadric surface $x^2 + y^2 = 1$ in Example 14.3.13.

9 Technically, we should also require that the polynomial can't be factored into the product of two polynomials of degree one.

10 This statement can be justified using a linear algebra eigenvalue/eigenvector analysis. It is beyond what we can cover here, but is not too difficult for a standard linear algebra course.

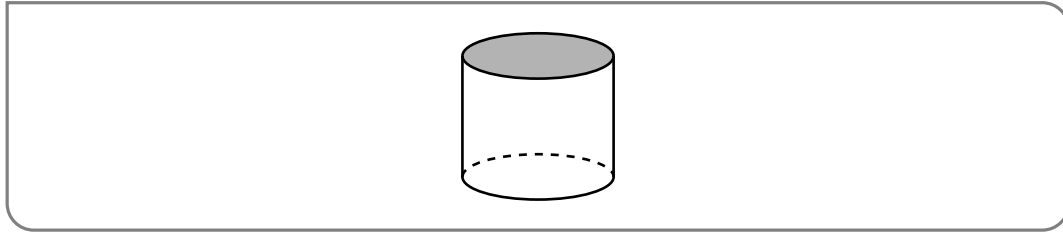

Its constant z cross sections are circles and its $x = 0$ and $y = 0$ cross sections are straight lines. It is called a right circular cylinder.

- the quadric surface $x^2 + (y - z)^2 = 1$ in Example 14.3.13, and
- We saw the quadric surface $yz = 1$ in Example 14.3.4.

Example 14.3.15 (Indifference curves)

Suppose a function $U(x, y)$ gives the happiness¹¹ (or *utility*) a consumer gains when they purchase x units of Good X and y units of Good Y. The level curves of the surface $z = U(x, y)$ are called *indifference curves*, because every point along that curve results in the same benefit to the consumer.

Suppose $U(x, y) = x\sqrt{y}$. The purchasing 2 units of Good X and one unit of Good Y produces the same benefit as purchasing 1 unit of Good X and 4 units of Good Y, because both these combinations are on the level curve $U(x, y) = 2$.

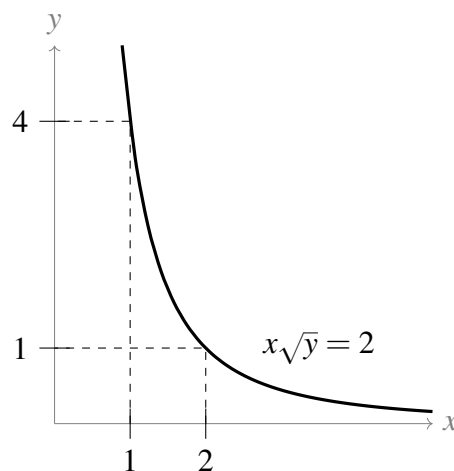

Let's make a small contour map of our surface $U(x, y) = x\sqrt{y}$, plotting several indifference curves. (Note $x\sqrt{y} = c$ is equivalent to $y = \frac{c^2}{x^2}$ in our model domain.)

11 An amusing thought experiment is to propose units for measuring happiness. "The one-point increase in GDP was associated with an average increase of 3.7 wrinkly puppy faces of happiness nation-wide."

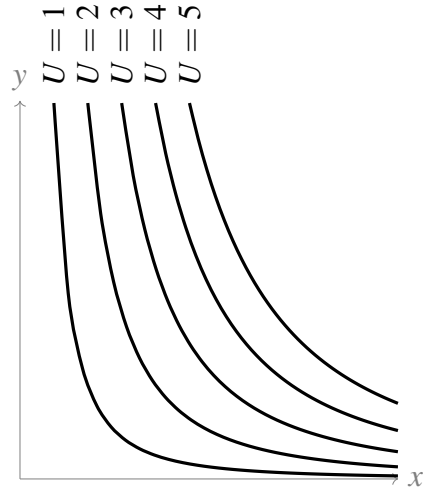

Not surprisingly, if we move roughly in the direction of the $(1, 1)$ (that is, increasing both x and y), our happiness $U(x, y)$ goes up.

Note that none of the indifference curves touch either of the x or y axes. It is clear enough from the formula that $U(0, y) = U(x, 0) = 0$. This is a common feature of utility functions: that to maximize utility, a consumer will have at least a little of both products, rather than consuming only one type.

Example 14.3.15

Chapter 15

(FLAVOUR C) PARTIAL DERIVATIVES

In this chapter we are going to generalize the definition of “derivative” to functions of more than one variable, and then we are going to use those derivatives. We can speed things up considerably by recycling what we have already learned in the single-variable case.

15.1 ▲ Partial derivatives**Learning Objectives**

- Compute partial derivatives of two-variable functions.
- Provide a physical interpretation of a partial derivative in terms of directional steepness at a point on a surface.

First, recall how we defined the derivative, $f'(a)$, of a function of one variable, $f(x)$. We imagined that we were walking along the x -axis, in the positive direction, measuring, for example, the temperature along the way. We denoted by $f(x)$ the temperature at x . The instantaneous rate of change of temperature that we observed as we passed through $x = a$ was

$$\frac{df}{dx}(a) = \lim_{h \rightarrow 0} \frac{f(a+h) - f(a)}{h} = \lim_{x \rightarrow a} \frac{f(x) - f(a)}{x - a}$$

Next suppose that we are walking in the xy -plane and that the temperature at (x,y) is $f(x,y)$. We can pass through the point $(x,y) = (a,b)$ moving in many different directions, and we cannot expect the measured rate of change of temperature if we walk parallel to the x -axis, in the direction of increasing x , to be the same as the measured rate of change of temperature if we walk parallel to the y -axis in the direction of increasing y . We'll start by considering just those two directions. Other directions (like walking parallel to the line $y = x$) later.

Suppose that we are passing through the point $(x,y) = (a,b)$ and that we are walking parallel to the x -axis (in the positive direction). Then our y -coordinate will be constant, always taking the value

$y = b$. So we can think of the measured temperature as the function of one variable $B(x) = f(x, b)$ and we will observe the rate of change of temperature

$$\frac{dB}{dx}(a) = \lim_{h \rightarrow 0} \frac{B(a+h) - B(a)}{h} = \lim_{h \rightarrow 0} \frac{f(a+h, b) - f(a, b)}{h}$$

This is called the “partial derivative f with respect to x at (a, b) ” and is denoted $\left(\frac{\partial f}{\partial x}\right)_y(a, b)$. Here

- the symbol ∂ , which is read “partial”, indicates that we are dealing with a function of more than one variable and
- the subscript y on $\left(\frac{\partial f}{\partial x}\right)_y$ indicates that y is being held fixed, i.e. being treated as a constant, and
- the x in $\frac{\partial f}{\partial x}$ indicates that we are differentiating with respect to x .
- $\frac{\partial f}{\partial x}$ is read “partial dee f dee x ”.

Do not write $\frac{d}{dx}$ when $\frac{\partial}{\partial x}$ is appropriate. (There exist situations when $\frac{d}{dx}f$ and $\frac{\partial}{\partial x}f$ are both defined and have different meanings.)

If, instead, we are passing through the point $(x, y) = (a, b)$ and are walking parallel to the y -axis (in the positive direction), then our x -coordinate will be constant, always taking the value $x = a$. So we can think of the measured temperature as the function of one variable $A(y) = f(a, y)$ and we will observe the rate of change of temperature

$$\frac{dA}{dy}(b) = \lim_{h \rightarrow 0} \frac{A(b+h) - A(b)}{h} = \lim_{h \rightarrow 0} \frac{f(a, b+h) - f(a, b)}{h}$$

This is called the “partial derivative f with respect to y at (a, b) ” and is denoted $\left(\frac{\partial f}{\partial y}\right)_x(a, b)$.

Just as was the case for the ordinary derivative $\frac{df}{dx}(x)$, it is common to treat the partial derivatives of $f(x, y)$ as functions of (x, y) simply by evaluating the partial derivatives at (x, y) rather than at (a, b) .

Definition 15.1.1 (Partial Derivatives).

The x - and y -partial derivatives of the function $f(x, y)$ are

$$\left(\frac{\partial f}{\partial x}\right)_y(x, y) = \lim_{h \rightarrow 0} \frac{f(x+h, y) - f(x, y)}{h}$$

$$\left(\frac{\partial f}{\partial y}\right)_x(x, y) = \lim_{h \rightarrow 0} \frac{f(x, y+h) - f(x, y)}{h}$$

respectively. The partial derivatives of functions of more than two variables are defined analogously.

Partial derivatives are used a lot. And there many notations for them.

Notation 15.1.2.

The partial derivative $\left(\frac{\partial f}{\partial x}\right)_y$ of a function $f(x,y)$ is also denoted

$$\frac{\partial f}{\partial x} \quad f_x \quad D_x f \quad D_1 f$$

The subscript 1 on $D_1 f$ indicates that f is being differentiated with respect to its first variable. The partial derivative $\left(\frac{\partial f}{\partial x}\right)_y(a,b)$ is also denoted

$$\frac{\partial f}{\partial x} \Big|_{(a,b)}$$

with the subscript (a,b) indicating that $\frac{\partial f}{\partial x}$ is being evaluated at $(x,y) = (a,b)$. The abbreviated notation $\frac{\partial f}{\partial x}$ for $\left(\frac{\partial f}{\partial x}\right)_y$ is extremely commonly used. But it is dangerous to do so, when it is not clear from the context, that it is the variable y that is being held fixed.

Remark 15.1.3 (The Geometric Interpretation of Partial Derivatives). We'll now develop a geometric interpretation of the partial derivative

$$\left(\frac{\partial f}{\partial x}\right)_y(a,b) = \lim_{h \rightarrow 0} \frac{f(a+h,b) - f(a,b)}{h}$$

in terms of the shape of the graph $z = f(x,y)$ of the function $f(x,y)$. That graph appears in the figure below. It looks like the part of a deformed sphere that is in the first octant.

The definition of $\left(\frac{\partial f}{\partial x}\right)_y(a,b)$ concerns only points on the graph that have $y = b$. In other words, the curve of intersection of the surface $z = f(x,y)$ with the plane $y = b$. That is the red curve in the figure. The two blue vertical line segments in the figure have heights $f(a,b)$ and $f(a+h,b)$, which are the two numbers in the numerator of $\frac{f(a+h,b) - f(a,b)}{h}$.

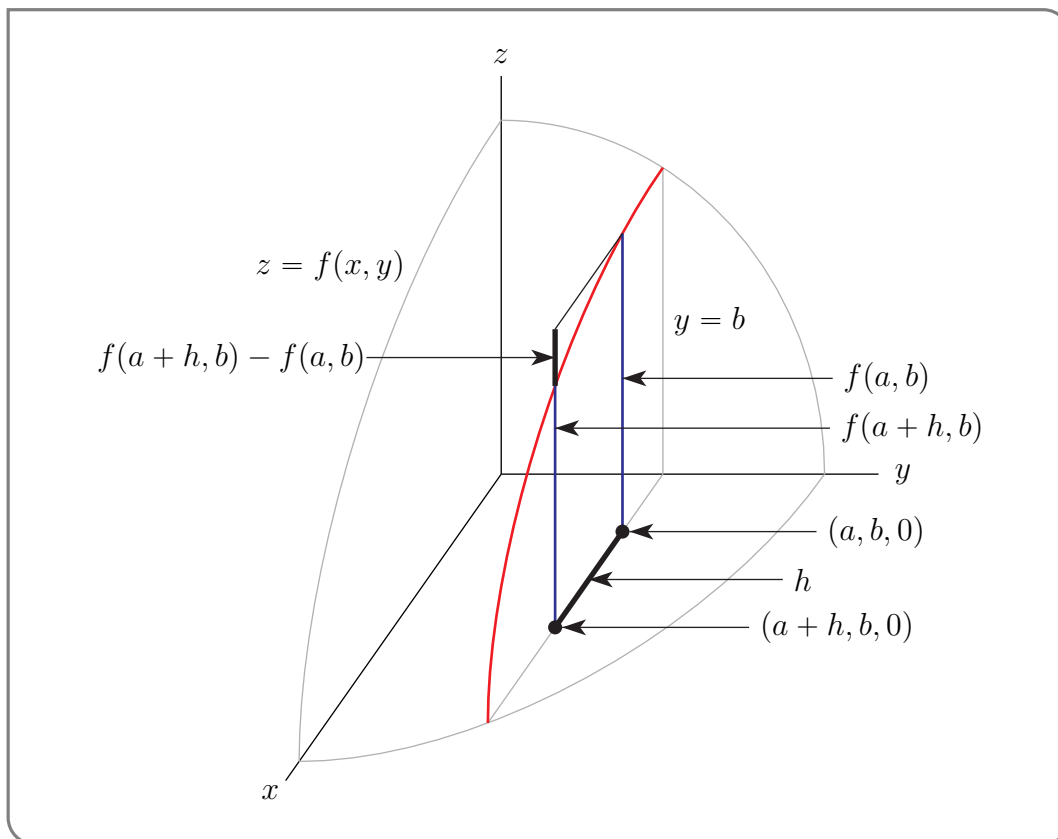

A side view of the curve (looking from the left side of the y -axis) is sketched in the figure below.

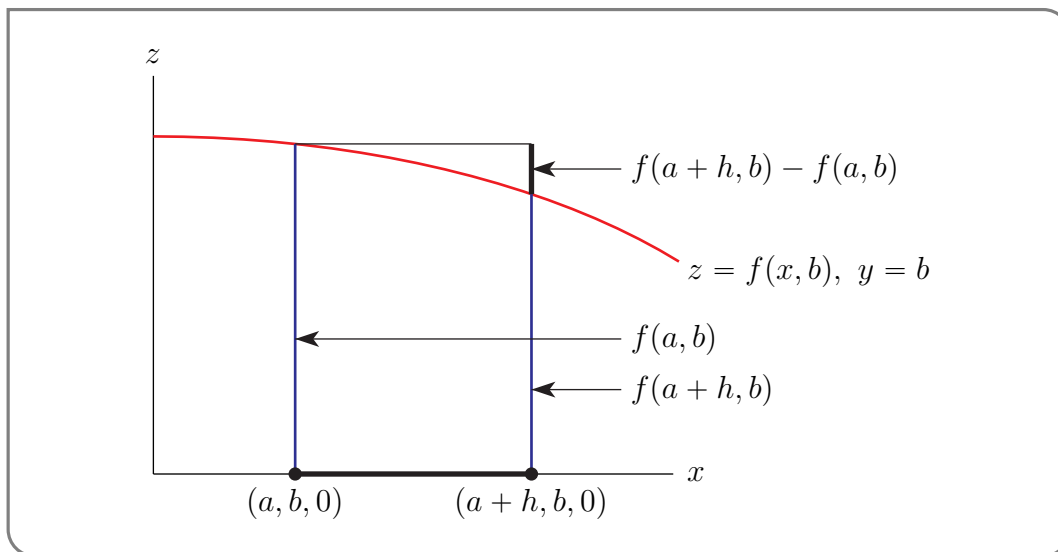

Again, the two blue vertical line segments in the figure have heights $f(a, b)$ and $f(a + h, b)$, which are the two numbers in the numerator of $\frac{f(a+h, b) - f(a, b)}{h}$. So the numerator $f(a + h, b) - f(a, b)$ and denominator h are the rise and run, respectively, of the curve $z = f(x, b)$ from $x = a$ to $x = a + h$. Thus $\left(\frac{\partial f}{\partial x}\right)_y(a, b)$ is exactly *the slope of (the tangent to) the curve of intersection of the surface $z = f(x, y)$ and the plane $y = b$ at the point $(a, b, f(a, b))$* . In the same way $\left(\frac{\partial f}{\partial y}\right)_x(a, b)$ is exactly *the slope of (the tangent to) the curve of intersection of the surface $z = f(x, y)$ and the plane $x = a$ at the point $(a, b, f(a, b))$* .

►►► Evaluation of Partial Derivatives

From the above discussion, we see that we can readily compute partial derivatives $\frac{\partial}{\partial x}$ by using what we already know about ordinary derivatives $\frac{d}{dx}$. More precisely,

- to evaluate $\frac{\partial f}{\partial x}(x, y)$, treat the y in $f(x, y)$ as a constant and differentiate the resulting function of x with respect to x .
- To evaluate $\frac{\partial f}{\partial y}(x, y)$, treat the x in $f(x, y)$ as a constant and differentiate the resulting function of y with respect to y .
- To evaluate $\frac{\partial f}{\partial x}(a, b)$, treat the y in $f(x, y)$ as a constant and differentiate the resulting function of x with respect to x . Then evaluate the result at $x = a, y = b$.
- To evaluate $\frac{\partial f}{\partial y}(a, b)$, treat the x in $f(x, y)$ as a constant and differentiate the resulting function of y with respect to y . Then evaluate the result at $x = a, y = b$.

Now for some examples.

Example 15.1.4

Let

$$f(x, y) = x^3 + y^2 + 4xy^2$$

Then, since $\frac{\partial}{\partial x}$ treats y as a constant,

$$\begin{aligned} \frac{\partial f}{\partial x} &= \left(\frac{\partial f}{\partial x} \right)_y = \frac{\partial}{\partial x}(x^3) + \frac{\partial}{\partial x}(y^2) + \frac{\partial}{\partial x}(4xy^2) \\ &= 3x^2 + 0 + 4y^2 \frac{\partial}{\partial x}(x) \\ &= 3x^2 + 4y^2 \end{aligned}$$

and, since $\frac{\partial}{\partial y}$ treats x as a constant,

$$\begin{aligned} \frac{\partial f}{\partial y} &= \left(\frac{\partial f}{\partial y} \right)_x = \frac{\partial}{\partial y}(x^3) + \frac{\partial}{\partial y}(y^2) + \frac{\partial}{\partial y}(4xy^2) \\ &= 0 + 2y + 4x \frac{\partial}{\partial y}(y^2) \\ &= 2y + 8xy \end{aligned}$$

In particular, at $(x, y) = (1, 0)$ these partial derivatives take the values

$$\begin{aligned} \frac{\partial f}{\partial x}(1, 0) &= 3(1)^2 + 4(0)^2 = 3 \\ \frac{\partial f}{\partial y}(1, 0) &= 2(0) + 8(1)(0) = 0 \end{aligned}$$

Example 15.1.5

Let

$$f(x, y) = y \cos x + x e^{xy}$$

Then, since $\frac{\partial}{\partial x}$ treats y as a constant, $\frac{\partial}{\partial x} e^{yx} = y e^{yx}$ and

$$\frac{\partial f}{\partial x}(x, y) = -y \sin x + e^{xy} + x y e^{xy}$$

$$\frac{\partial f}{\partial y}(x, y) = \cos x + x^2 e^{xy}$$

Example 15.1.5

Let's move up to a function of four variables. Things generalize in a quite straight forward way.

Example 15.1.6

Let

$$f(x, y, z, t) = x \sin(y + 2z) + t^2 e^{3y} \ln z$$

Then

$$\frac{\partial f}{\partial x}(x, y, z, t) = \sin(y + 2z)$$

$$\frac{\partial f}{\partial y}(x, y, z, t) = x \cos(y + 2z) + 3t^2 e^{3y} \ln z$$

$$\frac{\partial f}{\partial z}(x, y, z, t) = 2x \cos(y + 2z) + t^2 e^{3y} / z$$

$$\frac{\partial f}{\partial t}(x, y, z, t) = 2t e^{3y} \ln z$$

Example 15.1.6

Now here is a more complicated example — our function takes a special value at $(0, 0)$. To compute derivatives there we have to revert to the definition.

Example 15.1.7

Set

$$f(x, y) = \begin{cases} \frac{\cos x - \cos y}{x - y} & \text{if } x \neq y \\ 0 & \text{if } x = y \end{cases}$$

If $b \neq a$, then for all (x, y) sufficiently close to (a, b) , $f(x, y) = \frac{\cos x - \cos y}{x - y}$ and we can compute the partial derivatives of f at (a, b) using the familiar rules of differentiation. However that is not the case for $(a, b) = (0, 0)$. To evaluate $f_x(0, 0)$, we need to set $y = 0$ and find the derivative of

$$f(x, 0) = \begin{cases} \frac{\cos x - 1}{x} & \text{if } x \neq 0 \\ 0 & \text{if } x = 0 \end{cases}$$

with respect to x at $x = 0$. To do so, we basically have to apply the definition

$$\begin{aligned}
 f_x(0,0) &= \lim_{h \rightarrow 0} \frac{f(h,0) - f(0,0)}{h} \\
 &= \lim_{h \rightarrow 0} \frac{\frac{\cos h - 1}{h} - 0}{h} && \text{(Recall that } h \neq 0 \text{ in the limit.)} \\
 &= \lim_{h \rightarrow 0} \frac{\cos h - 1}{h^2} \\
 &= \lim_{h \rightarrow 0} \frac{-\sin h}{2h} && \text{(By l'Hôpital's rule.)} \\
 &= \lim_{h \rightarrow 0} \frac{-\cos h}{2} && \text{(By l'Hôpital again.)} \\
 &= -\frac{1}{2}
 \end{aligned}$$

Example 15.1.7

Example 15.1.8

Again set

$$f(x,y) = \begin{cases} \frac{\cos x - \cos y}{x - y} & \text{if } x \neq y \\ 0 & \text{if } x = y \end{cases}$$

We'll now compute $f_y(x,y)$ for all (x,y) .

The case $y \neq x$: When $y \neq x$,

$$\begin{aligned}
 f_y(x,y) &= \frac{\partial}{\partial y} \frac{\cos x - \cos y}{x - y} \\
 &= \frac{(x - y) \frac{\partial}{\partial y} (\cos x - \cos y) - (\cos x - \cos y) \frac{\partial}{\partial y} (x - y)}{(x - y)^2} && \text{by the quotient rule} \\
 &= \frac{(x - y) \sin y + \cos x - \cos y}{(x - y)^2}
 \end{aligned}$$

The case $y = x$: When $y = x$,

$$\begin{aligned}
 f_y(x,y) &= \lim_{h \rightarrow 0} \frac{f(x,y+h) - f(x,y)}{h} = \lim_{h \rightarrow 0} \frac{f(x,x+h) - f(x,x)}{h} \\
 &= \lim_{h \rightarrow 0} \frac{\frac{\cos x - \cos(x+h)}{x - (x+h)} - 0}{h} && \text{(Recall that } h \neq 0 \text{ in the limit.)} \\
 &= \lim_{h \rightarrow 0} \frac{\cos(x+h) - \cos x}{h^2}
 \end{aligned}$$

Now we apply L'Hôpital's rule, remembering that, in this limit, x is a constant and h is the variable — so we differentiate with respect to h .

$$f_y(x,y) = \lim_{h \rightarrow 0} \frac{-\sin(x+h)}{2h}$$

Note that if x is not an integer multiple of π , then the numerator $-\sin(x+h)$ does *not* tend to zero as h tends to zero, and the limit giving $f_y(x,y)$ does not exist. On the other hand, if x is an integer multiple of π , both the numerator and denominator tend to zero as h tends to zero, and we can apply L'Hôpital's rule a second time. Then

$$\begin{aligned} f_y(x,y) &= \lim_{h \rightarrow 0} \frac{-\cos(x+h)}{2} \\ &= -\frac{\cos x}{2} \end{aligned}$$

The conclusion:

$$f_y(x,y) = \begin{cases} \frac{(x-y)\sin y + \cos x - \cos y}{(x-y)^2} & \text{if } x \neq y \\ -\frac{\cos x}{2} & \text{if } x = y \text{ with } x \text{ an integer multiple of } \pi \\ DNE & \text{if } x = y \text{ with } x \text{ not an integer multiple of } \pi \end{cases}$$

Example 15.1.8

Our next example uses implicit differentiation.

Example 15.1.9

The equation

$$z^5 + y^2 e^z + e^{2x} = 0$$

implicitly determines z as a function of x and y . For example, when $x = y = 0$, the equation reduces to

$$z^5 = -1$$

which forces¹ $z(0,0) = -1$. Let's find the partial derivative $\frac{\partial z}{\partial x}(0,0)$.

We are not going to be able to explicitly solve the equation for $z(x,y)$. All we know is that

$$z(x,y)^5 + y^2 e^{z(x,y)} + e^{2x} = 0$$

for all x and y . We can turn this into an equation for $\frac{\partial z}{\partial x}(0,0)$ by differentiating² the whole equation with respect to x , giving

$$5z(x,y)^4 \frac{\partial z}{\partial x}(x,y) + y^2 e^{z(x,y)} \frac{\partial z}{\partial x}(x,y) + 2e^{2x} = 0$$

and then setting $x = y = 0$, giving

$$5z(0,0)^4 \frac{\partial z}{\partial x}(0,0) + 2 = 0$$

As we already know that $z(0,0) = -1$,

$$\frac{\partial z}{\partial x}(0,0) = -\frac{2}{5z(0,0)^4} = -\frac{2}{5}$$

1 The only real number z which obeys $z^5 = -1$ is $z = -1$. However there are four other complex numbers which also obey $z^5 = -1$.

2 You should have already seen this technique, called implicit differentiation, in your first Calculus course.

Example 15.1.9

Next we have a partial derivative disguised as a limit.

Example 15.1.10

In this example we are going to evaluate the limit

$$\lim_{z \rightarrow 0} \frac{(x+y+z)^3 - (x+y)^3}{(x+y)z}$$

The critical observation is that, in taking the limit $z \rightarrow 0$, x and y are fixed. They do not change as z is getting smaller and smaller. Furthermore this limit is exactly of the form of the limits in the Definition 15.1.1 of partial derivative, disguised by some obfuscating changes of notation.

Set

$$f(x, y, z) = \frac{(x+y+z)^3}{(x+y)}$$

Then

$$\begin{aligned} \lim_{z \rightarrow 0} \frac{(x+y+z)^3 - (x+y)^3}{(x+y)z} &= \lim_{z \rightarrow 0} \frac{f(x, y, z) - f(x, y, 0)}{z} = \lim_{h \rightarrow 0} \frac{f(x, y, 0+h) - f(x, y, 0)}{h} \\ &= \frac{\partial f}{\partial z}(x, y, 0) \\ &= \left[\frac{\partial}{\partial z} \frac{(x+y+z)^3}{x+y} \right]_{z=0} \end{aligned}$$

Recalling that $\frac{\partial}{\partial z}$ treats x and y as constants, we are evaluating the derivative of a function of the form $\frac{(\text{const}+z)^3}{\text{const}}$. So

$$\begin{aligned} \lim_{z \rightarrow 0} \frac{(x+y+z)^3 - (x+y)^3}{(x+y)z} &= 3 \frac{(x+y+z)^2}{x+y} \Big|_{z=0} \\ &= 3(x+y) \end{aligned}$$

Example 15.1.10

15.2 ▲ Higher order derivatives

Learning Objectives

- Compute the second order partial derivatives given a function of two variables.
- State without proof that the mixed partials should be equal for “nice” functions.

You have already observed, in your first Calculus course, that if $f(x)$ is a function of x , then its derivative, $\frac{df}{dx}(x)$, is also a function of x , and can be differentiated to give the second order derivative $\frac{d^2f}{dx^2}(x)$, which can in turn be differentiated yet again to give the third order derivative, $f^{(3)}(x)$, and so on.

We can do the same for functions of more than one variable. If $f(x,y)$ is a function of x and y , then both of its partial derivatives, $\frac{\partial f}{\partial x}(x,y)$ and $\frac{\partial f}{\partial y}(x,y)$ are also functions of x and y . They can both be differentiated with respect to x and they can both be differentiated with respect to y . So there are four possible second order derivatives. Here they are, together with various alternate notations.

$$\begin{aligned}\frac{\partial}{\partial x} \left(\frac{\partial f}{\partial x} \right) (x,y) &= \frac{\partial^2 f}{\partial x^2} (x,y) = f_{xx}(x,y) \\ \frac{\partial}{\partial y} \left(\frac{\partial f}{\partial x} \right) (x,y) &= \frac{\partial^2 f}{\partial y \partial x} (x,y) = f_{xy}(x,y) \\ \frac{\partial}{\partial x} \left(\frac{\partial f}{\partial y} \right) (x,y) &= \frac{\partial^2 f}{\partial x \partial y} (x,y) = f_{yx}(x,y) \\ \frac{\partial}{\partial y} \left(\frac{\partial f}{\partial y} \right) (x,y) &= \frac{\partial^2 f}{\partial y^2} (x,y) = f_{yy}(x,y)\end{aligned}$$

Warning 15.2.1.

In $\frac{\partial^2 f}{\partial y \partial x} = \frac{\partial^2 f}{\partial y \partial x}$, the derivative closest to f , in this case $\frac{\partial}{\partial x}$, is applied first. So we work through the variables in the bottom right-to-left.

In f_{xy} , the derivative with respect to the variable closest to f , in this case x , is applied first. So we work through the subscript variables left-to-right.

The difference in “direction” highlighted in the warning seems confusing at first, but it stems from the way the first partial derivative is written. In the fractional notation, if f is being differentiated with respect to x , we write $\frac{\partial f}{\partial x}$ or $\frac{\partial}{\partial x} f$. So the operator $\frac{\partial}{\partial x}$ is added to the *left* of the function. Now suppose we want to differentiate $\frac{\partial f}{\partial x}$ with respect to y . By analogy, we would write $\frac{\partial}{\partial y} \left[\frac{\partial f}{\partial x} \right]$, or $\frac{\partial^2 f}{\partial y \partial x}$. This leads to the order of variables being right-to-left.

With the subscript notation, if f is being differentiated with respect to x , we write f_x , with the variable on the *right* of the function. So now if we take the second derivative with respect to y , it makes sense by analogy to add that new variable to the right: $(f_x)_y$, or f_{xy} , in left-to-right order.

Example 15.2.2

Let $f(x,y) = e^{my} \cos(nx)$. Then

$$\begin{aligned}f_x &= -ne^{my} \sin(nx) & f_y &= me^{my} \cos(nx) \\ f_{xx} &= -n^2 e^{my} \cos(nx) & f_{yx} &= -mne^{my} \sin(nx) \\ f_{xy} &= -mne^{my} \sin(nx) & f_{yy} &= m^2 e^{my} \cos(nx)\end{aligned}$$

Example 15.2.2

Example 15.2.3

Let $f(x, y) = e^{\alpha x + \beta y}$. Then

$$\begin{aligned} f_x &= \alpha e^{\alpha x + \beta y} & f_y &= \beta e^{\alpha x + \beta y} \\ f_{xx} &= \alpha^2 e^{\alpha x + \beta y} & f_{yx} &= \beta \alpha e^{\alpha x + \beta y} \\ f_{xy} &= \alpha \beta e^{\alpha x + \beta y} & f_{yy} &= \beta^2 e^{\alpha x + \beta y} \end{aligned}$$

More generally, for any integers $m, n \geq 0$,

$$\frac{\partial^{m+n} f}{\partial x^m \partial y^n} = \alpha^m \beta^n e^{\alpha x + \beta y}$$

Example 15.2.3

Example 15.2.4

If $f(x_1, x_2, x_3, x_4) = x_1^4 x_2^3 x_3^2 x_4$, then

$$\begin{aligned} \frac{\partial^4 f}{\partial x_1 \partial x_2 \partial x_3 \partial x_4} &= \frac{\partial^3}{\partial x_1 \partial x_2 \partial x_3} (x_1^4 x_2^3 x_3^2) \\ &= \frac{\partial^2}{\partial x_1 \partial x_2} (2 x_1^4 x_2^3 x_3) \\ &= \frac{\partial}{\partial x_1} (6 x_1^4 x_2^2 x_3) \\ &= 24 x_1^3 x_2^2 x_3 \end{aligned}$$

and

$$\begin{aligned} \frac{\partial^4 f}{\partial x_4 \partial x_3 \partial x_2 \partial x_1} &= \frac{\partial^3}{\partial x_4 \partial x_3 \partial x_2} (4 x_1^3 x_2^3 x_3^2 x_4) \\ &= \frac{\partial^2}{\partial x_4 \partial x_3} (12 x_1^3 x_2^2 x_3^2 x_4) \\ &= \frac{\partial}{\partial x_4} (24 x_1^3 x_2^2 x_3 x_4) \\ &= 24 x_1^3 x_2^2 x_3 \end{aligned}$$

Example 15.2.4

Notice that in Example 15.2.2,

$$f_{xy} = f_{yx} = -mne^{my} \sin(nx)$$

and in Example 15.2.3

$$f_{xy} = f_{yx} = \alpha\beta e^{\alpha x + \beta y}$$

and in Example 15.2.4

$$\frac{\partial^4 f}{\partial x_1 \partial x_2 \partial x_3 \partial x_4} = \frac{\partial^4 f}{\partial x_4 \partial x_3 \partial x_2 \partial x_1} = 24 x_1^3 x_2^2 x_3$$

In all of these examples, it didn't matter what order we took the derivatives in. The following theorem³ shows that this was no accident.

Theorem 15.2.5 (Clairaut's Theorem⁴ or Schwarz's Theorem⁵).

If the partial derivatives $\frac{\partial^2 f}{\partial x \partial y}$ and $\frac{\partial^2 f}{\partial y \partial x}$ exist and are continuous at (x_0, y_0) , then

$$\frac{\partial^2 f}{\partial x \partial y}(x_0, y_0) = \frac{\partial^2 f}{\partial y \partial x}(x_0, y_0)$$

We won't use this theorem a whole lot in Math 105. It can occasionally be useful to note that as long as a function is continuous and differentiable, you can differentiate it in any "order."

Example 15.2.6

Let $f(x, y) = x^5 e^x + y$. Find f_{xxxy} .

Solution. Since $f(x, y)$ is continuous and differentiable everywhere, then the order of differentiation doesn't matter. Rather than starting with respect to x (which is harder), we start with respect to y (which is easier).

$$\begin{aligned} f_y &= 1 \\ f_{yx} &= 0 \implies f_{xy} = 0 \\ f_{xyx} &= 0 \implies f_{xxy} = 0 \\ f_{xxyx} &= 0 \implies f_{xxxy} = 0 \end{aligned}$$

Example 15.2.6

- 3 The history of this important theorem is pretty convoluted. See "A note on the history of mixed partial derivatives" by Thomas James Higgins which was published in *Scripta Mathematica* **7** (1940), 59-62.
- 4 Alexis Clairaut (1713-1765) was a French mathematician, astronomer, and geophysicist.
- 5 Hermann Schwarz (1843-1921) was a German mathematician.

(FLAVOUR C) OPTIMIZATION OF MULTIVARIABLE FUNCTIONS

16.1 ▲ Local maximum and minimum values

One of the core topics in single variable calculus courses is finding the maxima and minima of functions of one variable. We'll now extend that discussion to functions of more than one variable¹. To keep things simple, we'll focus on functions with two variables. It's worth noting, though, that many of the techniques we use will generalize to functions with even more. To start, we have the following natural extensions to some familiar definitions.

Definition 16.1.1.

Let the function $f(x,y)$ be defined for all (x,y) in some subset R of \mathbb{R}^2 . Let (a,b) be a point in R .

- (a,b) is a *local maximum* of $f(x,y)$ if $f(x,y) \leq f(a,b)$ for all (x,y) close to (a,b) . More precisely, (a,b) is a local maximum of $f(x,y)$ if there is an $r > 0$ such that $f(x,y) \leq f(a,b)$ for all points (x,y) within a distance r of (a,b) .
- (a,b) is a *local minimum* of $f(x,y)$ if $f(x,y) \geq f(a,b)$ for all (x,y) close to (a,b) .
- Local maximum and minimum values are also called extremal values.
- (a,b) is an *absolute maximum* or *global maximum* of $f(x,y)$ if $f(x,y) \leq f(a,b)$ for all (x,y) in R .
- (a,b) is an *absolute minimum* or *global minimum* of $f(x,y)$ if $f(x,y) \geq f(a,b)$ for all (x,y) in R .

¹ Life is not (always) one-dimensional and sometimes we have to embrace it.

16.1.1 ►► Critical points

Learning Objectives

- Define critical point and singular point for a function of two variables.
- Compute the critical points and singular points of a given function of two variables.
- State (without proof) that extreme values of a continuous multivariable function will occur at critical or singular points.
- Be able to visualize critical points as ‘flat spots.’

One of the first things you did when you were developing the techniques used to find the maximum and minimum values of $f(x)$ was to ask yourself²

Suppose that the largest value of $f(x)$ is $f(a)$. What does that tell us about a ?

After a little thought you answered

If the largest value of $f(x)$ is $f(a)$ and f is differentiable at a , then $f'(a) = 0$.

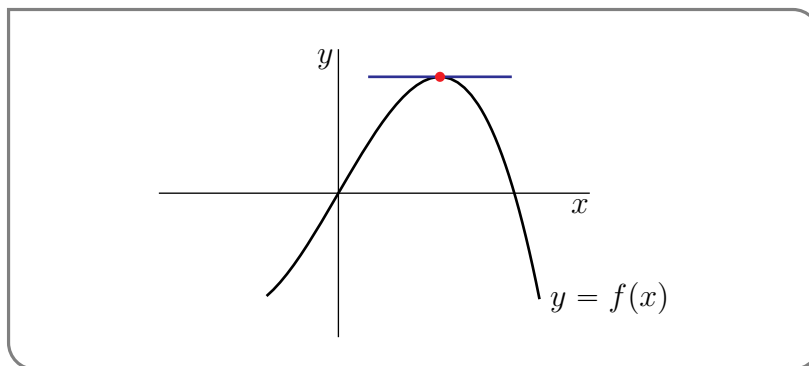

Let's recall why that's true. Suppose that the largest value of $f(x)$ is $f(a)$. Then for all $h > 0$,

$$f(a+h) \leq f(a) \implies f(a+h) - f(a) \leq 0 \implies \frac{f(a+h) - f(a)}{h} \leq 0 \quad \text{if } h > 0$$

Taking the limit $h \rightarrow 0$ tells us that $f'(a) \leq 0$. Similarly, for all $h < 0$,

$$f(a+h) \leq f(a) \implies f(a+h) - f(a) \leq 0 \implies \frac{f(a+h) - f(a)}{h} \geq 0 \quad \text{if } h < 0$$

Taking the limit $h \rightarrow 0$ now tells us that $f'(a) \geq 0$. So we have both $f'(a) \geq 0$ and $f'(a) \leq 0$ which forces $f'(a) = 0$.

You also observed at the time that for this argument to work, you only need $f(x) \leq f(a)$ for all x 's close to a , not necessarily for all x 's in the whole world. (In the above inequalities, we only used $f(a+h)$ with h small.) Since we care only about $f(x)$ for x near a , we can refine the above statement.

2 Or perhaps your instructor asked you.

If $f(a)$ is a local maximum for $f(x)$ and f is differentiable at a , then $f'(a) = 0$.

Precisely the same reasoning applies to minima.

If $f(a)$ is a local minimum for $f(x)$ and f is differentiable at a , then $f'(a) = 0$.

Let's use the ideas of the above discourse to extend the study of local maxima and local minima to functions of more than one variable. Suppose that the function $f(x,y)$ is defined for all (x,y) in some subset R of \mathbb{R}^2 , that (a,b) is point of R that is not on the boundary of R , and that f has a local maximum at (a,b) . See the figure below.

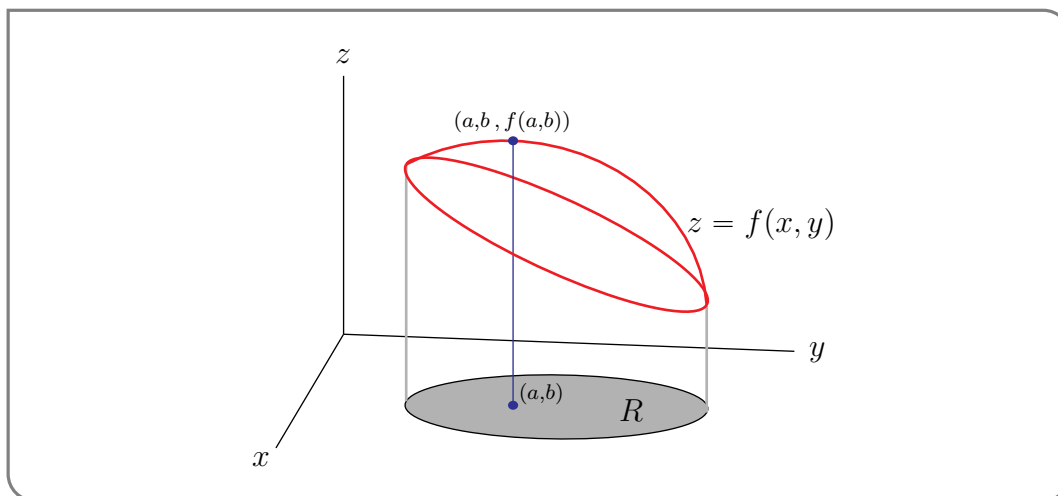

Then the function $f(x,y)$ must decrease in value as (x,y) moves away from (a,b) in *any* direction. If we change the x -coordinate a little, $f(x,y)$ must not increase. So for all $h > 0$:

$$f(a+h,b) \leq f(a,b) \implies f(a+h,b) - f(a,b) \leq 0 \implies \frac{f(a+h,b) - f(a,b)}{h} \leq 0 \quad \text{if } h > 0$$

Taking the limit $h \rightarrow 0$ tells us that $f_x(a,b) \leq 0$.

Similarly, for all $h < 0$,

$$f(a+h,b) \leq f(a,b) \implies f(a+h,b) - f(a,b) \leq 0 \implies \frac{f(a+h,b) - f(a,b)}{h} \geq 0 \quad \text{if } h < 0$$

Taking the limit $h \rightarrow 0$ now tells us that $f_x(a,b) \geq 0$. So we have both $f_x(a,b) \geq 0$ and $f_x(a,b) \leq 0$ which forces $f_x(a,b) = 0$. The same reasoning tells us $f_y(a,b) = 0$ as well, and that these partial derivatives are zero for minima as well as maxima.

This is an important and useful result, so let's theoremise it.

Theorem 16.1.2.

Let the function $f(x,y)$ be defined for all (x,y) in some subset R of \mathbb{R}^2 . Assume that

- (a,b) is a point of R that is not on the boundary of R and
- (a,b) is a local maximum or local minimum of f and that
- the partial derivatives of f exist at (a,b) .

Then

$$f_x(a,b) = 0$$
$$\text{and } f_y(a,b) = 0$$

Definition 16.1.3.

Let $f(x,y)$ be a function and let (a,b) be a point in its domain. Then we call (a,b) a *critical point* (or a *stationary point*) of the function if

- $f_x(a,b)$ does not exist, **or**
- $f_y(a,b)$ does not exist, **or**
- $f_x(a,b) = f_y(a,b) = 0$.

Warning 16.1.4.

Note that some people (and texts) do not include the cases where one or both partial derivatives do not exist in the definition of a critical point. These points would (usually) be referred as a singular point of the function. We do not use this terminology.

Warning 16.1.5.

Theorem 16.1.2 tells us that every local maximum or minimum (in the interior of the domain of a differentiable function) is a critical point. Beware that it does *not*³ tell us that every critical point is either a local maximum or a local minimum.

In fact, as we shall see in Example 16.1.12, critical points that are neither local maxima nor a local minima. None-the-less, Theorem 16.1.2 is very useful because often functions have only a small number of critical points. To find local maxima and minima of such functions, we only need

3 A very common error of logic that people make is “Affirming the consequent”. “If P then Q” is true, does not imply that “If Q then P” is true. The statement “If he is Shakespeare then he is dead” is true. But concluding from “That sheep is dead” that “He must be Shakespeare” is just silly.

to consider its critical points. We'll return later to the question of how to tell if a critical point is a local maximum, local minimum or neither. For now, we'll just practice finding critical points.

Example 16.1.6 ($f(x,y) = x^2 - 2xy + 2y^2 + 2x - 6y + 12$)

Find all critical points of $f(x,y) = x^2 - 2xy + 2y^2 + 2x - 6y + 12$.

Solution. To find the critical points, we need to find the first order partial derivatives. So, as a preliminary calculation, we find the two first order partial derivatives of $f(x,y)$.

$$\begin{aligned}f_x(x,y) &= 2x - 2y + 2 \\f_y(x,y) &= -2x + 4y - 6\end{aligned}$$

These functions are defined everywhere. So the critical points are the solutions of the pair of equations

$$2x - 2y + 2 = 0 \quad -2x + 4y - 6 = 0$$

or equivalently (dividing by two and moving the constants to the right hand side)

$$x - y = -1 \tag{E1}$$

$$-x + 2y = 3 \tag{E2}$$

This is a system of two equations in two unknowns (x and y). One strategy for solving system like this is to

- First use one of the equations to solve for one of the unknowns in terms of the other unknown. For example, (E1) tells us that $y = x + 1$. This expresses y in terms of x . We say that we have solved for y in terms of x .
- Then substitute the result, $y = x + 1$ in our case, into the other equation, (E2). In our case, this gives

$$-x + 2(x + 1) = 3 \iff x + 2 = 3 \iff x = 1$$

- We have now found that $x = 1, y = x + 1 = 2$ is the only solution. So the only critical point is $(1, 2)$. Of course it only takes a moment to verify that $f_x(1, 2) = f_y(1, 2) = 0$. It is a good idea to do this as a simple check of our work.

An alternative strategy for solving a system of two equations in two unknowns, like (E1) and (E2), is to

- add equations (E1) and (E2) together. This gives

$$(E1) + (E2) : (1 - 1)x + (-1 + 2)y = -1 + 3 \iff y = 2$$

The point here is that adding equations (E1) and (E2) together eliminates the unknown x , leaving us with one equation in the unknown y , which is easily solved. For other systems of equations you might have to multiply the equations by some numbers before adding them together.

- We now know that $y = 2$. Substituting it into (E1) gives us

$$x - 2 = -1 \implies x = 1$$

- Once again (thankfully) we have found that the only critical point is $(1, 2)$.

Example 16.1.6

This was pretty easy because we only had to solve linear equations, which in turn was a consequence of the fact that $f(x, y)$ was a polynomial of degree two. Here is an example with some slightly more challenging algebra.

Example 16.1.7 ($f(x, y) = 2x^3 - 6xy + y^2 + 4y$)

Find all critical points of $f(x, y) = 2x^3 - 6xy + y^2 + 4y$.

Solution. As in the last example, we need to find where the partial derivatives do not exist or are zero.

$$f_x = 6x^2 - 6y \quad f_y = -6x + 2y + 4$$

These functions are defined everywhere. So the critical points are the solutions of

$$6x^2 - 6y = 0 \quad -6x + 2y + 4 = 0$$

We can rewrite the first equation as $y = x^2$, which expresses y as a function of x . We can then substitute $y = x^2$ into the second equation, giving

$$\begin{aligned} -6x + 2y + 4 = 0 &\iff -6x + 2x^2 + 4 = 0 \iff x^2 - 3x + 2 = 0 \iff (x-1)(x-2) = 0 \\ &\iff x = 1 \text{ or } 2 \end{aligned}$$

When $x = 1$, $y = 1^2 = 1$ and when $x = 2$, $y = 2^2 = 4$. So, there are two critical points: $(1, 1)$, $(2, 4)$.

Alternatively, we could have also used the second equation to write $y = 3x - 2$, and then substituted that into the first equation to get

$$6x^2 - 6(3x - 2) = 0 \iff x^2 - 3x + 2 = 0$$

just as above.

Example 16.1.7

And here is an example for which the algebra requires a bit more thought.

Example 16.1.8 ($f(x, y) = xy(5x + y - 15)$)

Find all critical points of $f(x, y) = xy(5x + y - 15)$.

Solution. The first order partial derivatives of $f(x, y) = xy(5x + y - 15)$ are

$$f_x(x, y) = y(5x + y - 15) + xy(5) = y(5x + y - 15) + y(5x) = y(10x + y - 15)$$

$$f_y(x, y) = x(5x + y - 15) + xy(1) = x(5x + y - 15) + x(y) = x(5x + 2y - 15)$$

Therefore the partial derivatives of the function exist everywhere in the domain of the function. The critical points are the solutions of $f_x(x, y) = f_y(x, y) = 0$. That is, we need to find all x, y that satisfy the pair of equations

$$y(10x + y - 15) = 0 \tag{E1}$$

$$x(5x + 2y - 15) = 0 \tag{E2}$$

The first equation, $y(10x + y - 15) = 0$, is satisfied if at least one of the two factors y , $(10x + y - 15)$ is zero. So the first equation is satisfied if at least one of the two equations

$$y = 0 \quad (\text{E1a})$$

$$10x + y = 15 \quad (\text{E1b})$$

is satisfied. The second equation, $x(5x + 2y - 15) = 0$, is satisfied if at least one of the two factors x , $(5x + 2y - 15)$ is zero. So the second equation is satisfied if at least one of the two equations

$$x = 0 \quad (\text{E2a})$$

$$5x + 2y = 15 \quad (\text{E2b})$$

is satisfied.

So both critical point equations (E1) and (E2) are satisfied if and only if at least one of (E1a), (E1b) is satisfied and in addition at least one of (E2a), (E2b) is satisfied. So both critical point equations (E1) and (E2) are satisfied if and only if at least one of the following four possibilities hold.

- (E1a) and (E2a) are satisfied if and only if $x = y = 0$
- (E1a) and (E2b) are satisfied if and only if $y = 0$, $5x + 2y = 15 \iff y = 0$, $5x = 15$
- (E1b) and (E2a) are satisfied if and only if $10x + y = 15$, $x = 0 \iff y = 15$, $x = 0$
- (E1b) and (E2b) are satisfied if and only if $10x + y = 15$, $5x + 2y = 15$. We can use, for example, the second of these equations to solve for x in terms of y : $x = \frac{1}{5}(15 - 2y)$. When we substitute this into the first equation we get $2(15 - 2y) + y = 15$, which we can solve for y . This gives $-3y = 15 - 30$ or $y = 5$ and then $x = \frac{1}{5}(15 - 2 \times 5) = 1$.

In conclusion, the critical points are $(0,0)$, $(3,0)$, $(0,15)$ and $(1,5)$.

A more compact way to write what we have just done is

$$\begin{aligned} & f_x(x,y) = 0 \quad \text{and} \quad f_y(x,y) = 0 \\ \iff & y(10x + y - 15) = 0 \quad \text{and} \quad x(5x + 2y - 15) = 0 \\ \iff & \{y = 0 \text{ or } 10x + y = 15\} \quad \text{and} \quad \{x = 0 \text{ or } 5x + 2y = 15\} \\ \iff & \{y = 0, x = 0\} \text{ or } \{y = 0, 5x + 2y = 15\} \text{ or } \{10x + y = 15, x = 0\} \text{ or} \\ & \{10x + y = 15, 5x + 2y = 15\} \\ \iff & \{x = y = 0\} \text{ or } \{y = 0, x = 3\} \text{ or } \{x = 0, y = 15\} \text{ or } \{x = 1, y = 5\} \end{aligned}$$

Example 16.1.8

Let's try a more practical example — something from the real world. Well, a mathematician's "real world". The interested reader should search-engine their way to a discussion of "idealisation", "game theory" "Cournot models" and "Bertrand models". But don't spend too long there. A discussion of breweries is about to take place.

Example 16.1.9

In a certain community, there are two breweries in competition⁴, so that sales of each negatively

⁴ We have both types of music here — country and western.

affect the profits of the other. If brewery A produces x litres of beer per month and brewery B produces y litres per month, then the profits of the two breweries are given by

$$P = 2x - \frac{2x^2 + y^2}{10^6} \quad Q = 2y - \frac{4y^2 + x^2}{2 \times 10^6}$$

respectively. Find the sum of the two profits if each brewery independently sets its own production level to maximize its own profit and assumes that its competitor does likewise. Then, assuming cartel behaviour, find the sum of the two profits if the two breweries cooperate so as to maximize that sum⁵.

Solution. If A adjusts x to maximize P (for y held fixed) and B adjusts y to maximize Q (for x held fixed) then we want to find the (x, y) using

$$P_x = 2 - \frac{4x}{10^6}$$

$$Q_y = 2 - \frac{8y}{2 \times 10^6}$$

Note that P_x and Q_y exists everywhere. Then x and y are determined by the equations

$$P_x = 0 \quad (\text{E1})$$

$$Q_y = 0 \quad (\text{E2})$$

Equation (E1) yields $x = \frac{1}{2}10^6$ and equation (E2) yields $y = \frac{1}{2}10^6$. Knowing x and y we can determine P , Q and the total profit

$$P + Q = 2(x + y) - \frac{1}{10^6} \left(\frac{5}{2}x^2 + 3y^2 \right)$$

$$= 10^6 \left(1 + 1 - \frac{5}{8} - \frac{3}{4} \right) = \frac{5}{8}10^6$$

On the other hand if (A, B) adjust (x, y) to maximize $P + Q = 2(x + y) - \frac{1}{10^6} \left(\frac{5}{2}x^2 + 3y^2 \right)$, then x and y are determined by

$$(P + Q)_x = 2 - \frac{5x}{10^6} = 0 \quad (\text{E1})$$

$$(P + Q)_y = 2 - \frac{6y}{10^6} = 0 \quad (\text{E2})$$

Equation (E1) yields $x = \frac{2}{5}10^6$ and equation (E2) yields $y = \frac{1}{3}10^6$. Again knowing x and y we can determine the total profit

$$P + Q = 2(x + y) - \frac{1}{10^6} \left(\frac{5}{2}x^2 + 3y^2 \right)$$

$$= 10^6 \left(\frac{4}{5} + \frac{2}{3} - \frac{2}{5} - \frac{1}{3} \right) = \frac{11}{15}10^6$$

So cooperating really does help their profits. Unfortunately, like a very small tea-pot, consumers will be a little poorer⁶.

Example 16.1.9

Moving swiftly away from the last pun, let's do something a little more geometric.

Example 16.1.10

Equal angle bends are made at equal distances from the two ends of a 100 metre long fence so the resulting three segment fence can be placed along an existing wall to make an enclosure of trapezoidal shape. What is the largest possible area for such an enclosure?

5 This sort of thing is generally illegal.

6 The authors extend their deepest apologies.

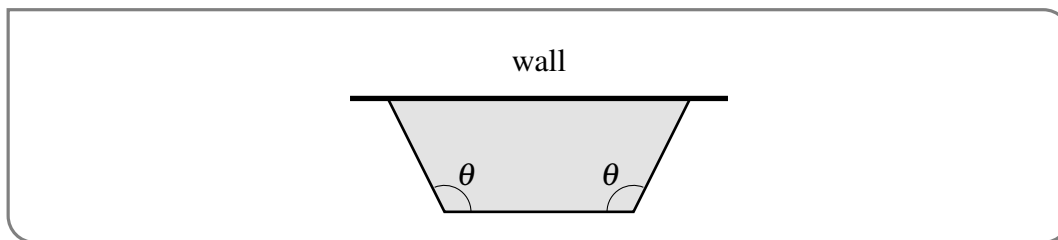

Solution. This is a very geometric problem (fenced off from pun opportunities), and as such we should start by drawing a sketch and introducing some variable names.

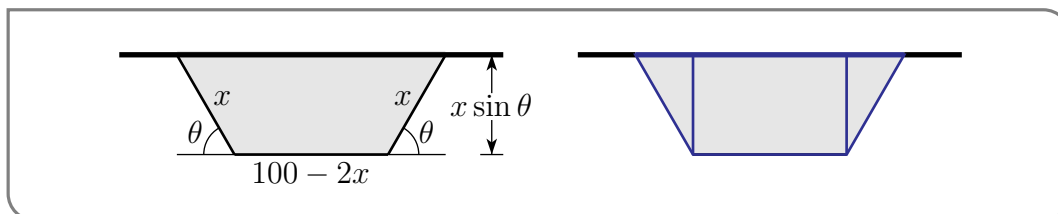

The area enclosed by the fence is the area inside the blue rectangle (in the figure on the right above) plus the area inside the two blue triangles.

$$\begin{aligned} A(x, \theta) &= (100 - 2x)x \sin \theta + 2 \cdot \frac{1}{2} \cdot x \sin \theta \cdot x \cos \theta \\ &= (100x - 2x^2) \sin \theta + x^2 \sin \theta \cos \theta \end{aligned}$$

To maximize the area, we need to solve

$$\begin{aligned} 0 &= \frac{\partial A}{\partial x} = (100 - 4x) \sin \theta + 2x \sin \theta \cos \theta \\ 0 &= \frac{\partial A}{\partial \theta} = (100x - 2x^2) \cos \theta + x^2 \{ \cos^2 \theta - \sin^2 \theta \} \end{aligned}$$

Note that $\frac{\partial A}{\partial x}$ and $\frac{\partial A}{\partial \theta}$ are defined everywhere in their domain (so here the critical points are the points where both partial derivatives are zero). Both terms in the first equation contain the factor $\sin \theta$ and all terms in the second equation contain the factor x . If either $\sin \theta$ or x are zero the area $A(x, \theta)$ will also be zero, and so will certainly not be maximal. So we may divide the first equation by $\sin \theta$ and the second equation by x , giving

$$(100 - 4x) + 2x \cos \theta = 0 \quad (\text{E1})$$

$$(100 - 2x) \cos \theta + x \{ \cos^2 \theta - \sin^2 \theta \} = 0 \quad (\text{E2})$$

These equations might look a little scary. But there is no need to panic. They are not as bad as they look because θ enters only through $\cos \theta$ and $\sin^2 \theta$, which we can easily write in terms of $\cos \theta$. Furthermore we can eliminate $\cos \theta$ by observing that the first equation forces $\cos \theta = -\frac{100-4x}{2x}$ and hence $\sin^2 \theta = 1 - \cos^2 \theta = 1 - \frac{(100-4x)^2}{4x^2}$. Substituting these into the second equation gives

$$\begin{aligned} &-(100 - 2x) \frac{100 - 4x}{2x} + x \left[\frac{(100 - 4x)^2}{2x^2} - 1 \right] = 0 \\ \implies &-(100 - 2x)(100 - 4x) + (100 - 4x)^2 - 2x^2 = 0 \\ \implies &6x^2 - 200x = 0 \\ \implies &x = \frac{100}{3} \quad \cos \theta = -\frac{100/3}{200/3} = -\frac{1}{2} \quad \theta = 60^\circ \end{aligned}$$

and the maximum area enclosed is

$$A = \left(100 \frac{100}{3} - 2 \frac{100^2}{3^2}\right) \frac{\sqrt{3}}{2} + \frac{1}{2} \frac{100^2 \sqrt{3}}{3^2} \frac{\sqrt{3}}{2} = \frac{2500}{\sqrt{3}}$$

Example 16.1.10

Now here is a very useful (even practical!) statistical example — finding the line that best fits a given collection of points.

Example 16.1.11 (Linear regression)

An experiment yields n data points (x_i, y_i) , $i = 1, 2, \dots, n$. We wish to find the straight line $y = mx + b$ which “best” fits the data. The definition of “best” is “minimizes the root mean

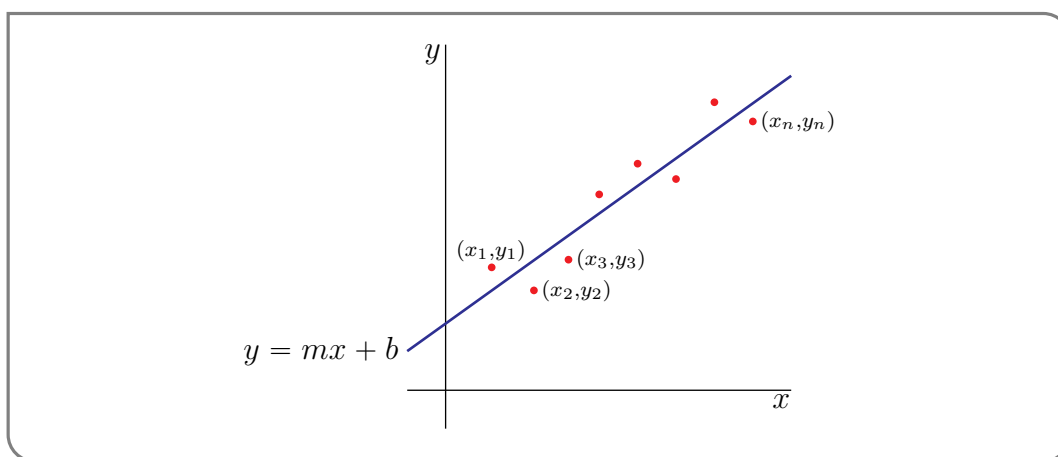

square error”, i.e. minimizes

$$E(m, b) = \sum_{i=1}^n (mx_i + b - y_i)^2$$

Note that

- term number i in $E(m, b)$ is the square of the difference between y_i , which is the i^{th} measured value of y , and $\left[mx + b \right]_{x=x_i}$, which is the approximation to y_i given by the line $y = mx + b$.
- All terms in the sum are positive, regardless of whether the points (x_i, y_i) are above or below the line.

Our problem is to find the m and b that minimizes $E(m, b)$. This technique for drawing a line through a bunch of data points is called “linear regression”. It is used *a lot*^{7 8}. Even in the real world — and not just the real world that you find in mathematics problems. The actual real world that involves jobs.

7 Proof by search engine.

8 And has been used for a long time. It was introduced by the French mathematician Adreïn-Marie Legendre, 1752–1833, in 1805, and by the German mathematician and physicist Carl Friedrich Gauss, 1777–1855, in 1809.

Solution. We wish to choose m and b so as to minimize $E(m, b)$. So we need to determine where the partial derivatives of E do not exist, or exist and are equal to zero.

$$\begin{aligned}\frac{\partial E}{\partial m} &= \sum_{i=1}^n 2(mx_i + b - y_i)x_i = m \left[\sum_{i=1}^n 2x_i^2 \right] + b \left[\sum_{i=1}^n 2x_i \right] - \left[\sum_{i=1}^n 2x_i y_i \right] \\ \frac{\partial E}{\partial b} &= \sum_{i=1}^n 2(mx_i + b - y_i) = m \left[\sum_{i=1}^n 2x_i \right] + b \left[\sum_{i=1}^n 2 \right] - \left[\sum_{i=1}^n 2y_i \right]\end{aligned}$$

There are a lot of symbols here. But remember that all of the x_i 's and y_i 's are given constants. They come from, for example, experimental data. The only unknowns are m and b . To emphasize this, and to save some writing, define the constants

$$S_x = \sum_{i=1}^n x_i \quad S_y = \sum_{i=1}^n y_i \quad S_{x^2} = \sum_{i=1}^n x_i^2 \quad S_{xy} = \sum_{i=1}^n x_i y_i$$

The partial derivatives of E exists everywhere so we only need to find where they are equal to zero. The equations which determine the critical points are (after dividing by two)

$$0 = S_{x^2} m + S_x b - S_{xy} \implies S_{x^2} m + S_x b = S_{xy} \quad (\text{E1})$$

$$0 = S_x m + nb - S_y \implies S_x m + nb = S_y \quad (\text{E2})$$

These are two linear equations on the unknowns m and b . They may be solved in any of the usual ways. One is to use (E2) to solve for b in terms of m

$$b = \frac{1}{n}(S_y - S_x m) \quad (\text{E3})$$

and then substitute this into (E1) to get the equation

$$S_{x^2} m + \frac{1}{n} S_x (S_y - S_x m) = S_{xy} \implies (nS_{x^2} - S_x^2) m = nS_{xy} - S_x S_y$$

for m . We can then solve this equation for m and substitute back into (E3) to get b . This gives

$$m = \frac{nS_{xy} - S_x S_y}{nS_{x^2} - S_x^2} \quad b = -\frac{S_x S_{xy} - S_y S_{x^2}}{nS_{x^2} - S_x^2}$$

Another way to solve the system of equations is

$$\begin{aligned}n(\text{E1}) - S_x(\text{E2}) : & \quad \left[nS_{x^2} - S_x^2 \right] m = nS_{xy} - S_x S_y \\ -S_x(\text{E1}) + S_{x^2}(\text{E2}) : & \quad \left[nS_{x^2} - S_x^2 \right] b = -S_x S_{xy} + S_y S_{x^2}\end{aligned}$$

which gives the same solution.

So given a bunch of data points, it only takes a quick bit of arithmetic — no calculus required — to apply the above formulae and so to find the best fitting line. Of course while you don't need any calculus to apply the formulae, you do need calculus to understand where they came from. The same technique can be extended to other types of curve fitting problems. For example, polynomial regression.

16.1.2 ▶▶ Classifying critical points

Learning Objectives

- Use the second derivative test to classify critical points as either local maximums, local minimums, or saddle points.
- Explain using words or pictures what a saddle point is.

Now let's start thinking about how to tell if a critical point is a local minimum, local maximum, or neither. We'll start with an intuitive approach, then introduce the (multivariable) Second Derivative Test.

You have already encountered single variable functions that have a critical point which is neither a local max nor a local min. This can also happen for functions of two variables. We'll start with the simplest possible such example.

Example 16.1.12 ($f(x,y) = x^2 - y^2$)

The first partial derivatives of $f(x,y) = x^2 - y^2$ are $f_x(x,y) = 2x$ and $f_y(x,y) = -2y$. So the only critical point of this function is $(0,0)$. Is this a local minimum or maximum? Well let's start with (x,y) at $(0,0)$ and then move (x,y) away from $(0,0)$ and see if $f(x,y)$ gets bigger or smaller. At the origin $f(0,0) = 0$. Of course we can move (x,y) away from $(0,0)$ in many different directions.

- First consider moving (x,y) along the x -axis. Then $(x,y) = (x,0)$ and $f(x,y) = f(x,0) = x^2$. So when we start with $x = 0$ and then increase x , the value of the function f increases — which means that $(0,0)$ cannot be a local maximum for f .
- Next let's move (x,y) away from $(0,0)$ along the y -axis. Then $(x,y) = (0,y)$ and $f(x,y) = f(0,y) = -y^2$. So when we start with $y = 0$ and then increase y , the value of the function f decreases — which means that $(0,0)$ cannot be a local minimum for f .

So moving away from $(0,0)$ in one direction causes the value of f to increase, while moving away from $(0,0)$ in a second direction causes the value of f to decrease. Consequently $(0,0)$ is neither a local minimum or maximum for f . It is called a saddle point, because the graph of f looks like a saddle. (The full definition of “saddle point” is given immediately after this example.) Here are some figures showing the graph of f .

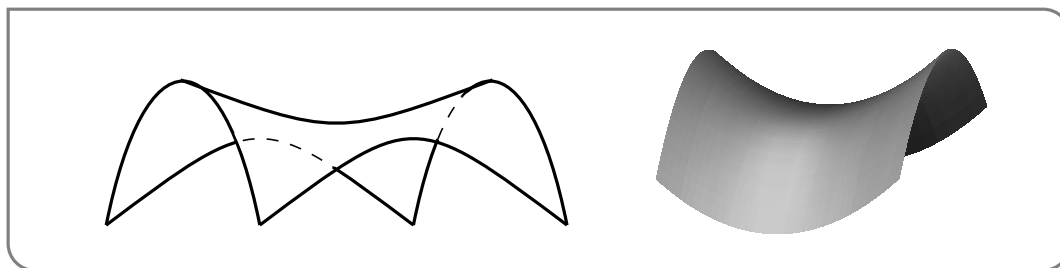

The figure below show some level curves of f . Observe from the level curves that

- f increases as you leave $(0,0)$ walking along the x axis
- f decreases as you leave $(0,0)$ walking along the y axis

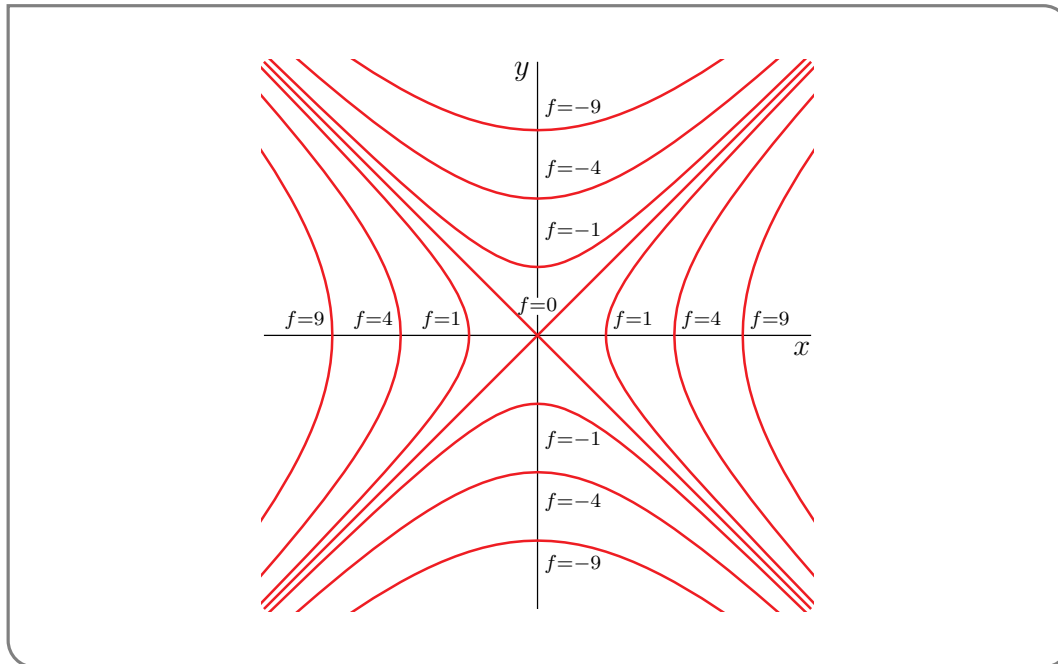

Example 16.1.12

Approximately speaking, if a critical point (a, b) is neither a local minimum nor a local maximum, then it is a saddle point. For (a, b) to not be a local minimum, f has to take values smaller than $f(a, b)$ at some points nearby (a, b) . For (a, b) to not be a local maximum, f has to take values bigger than $f(a, b)$ at some points nearby (a, b) . Writing this more mathematically we get the following definition.

Definition 16.1.13.

The critical point (a, b) is called a saddle point for the function $f(x, y)$ if, for each $r > 0$,

- there is at least one point (x, y) , within a distance r of (a, b) , for which $f(x, y) > f(a, b)$ and
- there is at least one point (x, y) , within a distance r of (a, b) , for which $f(x, y) < f(a, b)$.

Understanding what the graph of a function looks like is a powerful tool for classifying critical points, but it can be very time-consuming. The Second Derivative Test (below) is a more algebraic approach to classification. This test is often faster than graphing, but the drawback is that it is sometimes inconclusive.

Theorem 16.1.14 (Second Derivative Test).

Let $r > 0$ and assume that all second order derivatives of the function $f(x, y)$ are continuous at all points (x, y) that are within a distance r of (a, b) . Assume that $f_x(a, b) = f_y(a, b) = 0$. Define

$$D(x, y) = f_{xx}(x, y) f_{yy}(x, y) - f_{xy}(x, y)^2$$

It is called the discriminant of f . Then

- if $D(a, b) > 0$ and $f_{xx}(a, b) > 0$, then $f(x, y)$ has a local minimum at (a, b) ,
- if $D(a, b) > 0$ and $f_{xx}(a, b) < 0$, then $f(x, y)$ has a local maximum at (a, b) ,
- if $D(a, b) < 0$, then $f(x, y)$ has a saddle point at (a, b) , but
- if $D(a, b) = 0$, then we cannot draw any conclusions without more work.

The proof of Theorem 16.1.14 is beyond the scope of Math 105, but there is some intuition supporting it that is more accessible. Extremely informally, we can think of saddle points as places with inconsistent concavity: in some directions the surface looks concave up, in other directions it looks concave down. On the other hand, at a local extremum, the concavity is the same in all directions.

Let's do thought experiments on a few simple cases to expand those ideas.

Example 16.1.15 (Second Derivative Test Intuition)

Let (a, b) be a critical point of the function $f(x, y)$ with $f_x(a, b) = f_y(a, b) = 0$, and assume all second-order derivatives of $f(x, y)$ are continuous.

1. Suppose at (a, b) , the surface looks like a minimum if y is held constant, but it looks like a maximum if x is held constant. (In particular, this means (a, b) is the location of a saddle point.)

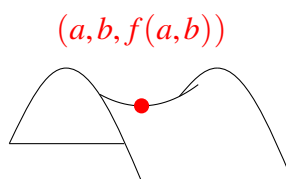

Holding $y = b$ constant, we can think of $z = f(x, b)$ as a one-variable function, in which case $f_{xx}(a, b) \geq 0$ by the single-variable second derivative test. Holding $x = a$ constant, we can think of $z = f(a, y)$ as a one-variable function (whose variable is y). In that case, $f_{yy}(a, b) \leq 0$ by the single-variable second derivative test.

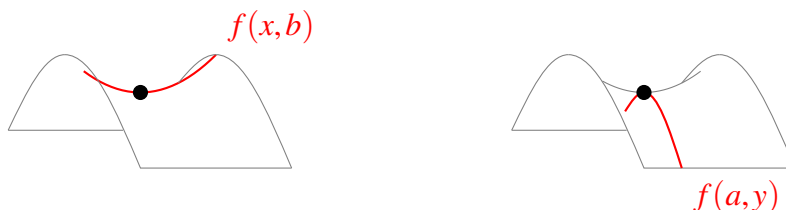

Since $f_{xx}(a,b)$ and $f_{yy}(a,b)$ have different signs (or at least one of them is zero):

$$\begin{aligned} f_{xx}(a,b)f_{yy}(a,b) &\leq 0 \\ f_{xx}(a,b)f_{yy}(a,b) - f_{xy}^2(a,b) &\leq -f_{xy}^2(a,b) \leq 0 \\ D(a,b) &\leq 0 \end{aligned}$$

So in this simple saddle-point example, we expect $D(a,b) \leq 0$. This accords with the third bullet point in Theorem 16.1.14.

2. Suppose $D(a,b) > 0$.

$$\begin{aligned} 0 &< f_{xx}(a,b)f_{yy}(a,b) - f_{xy}^2(a,b) \\ f_{xy}^2(a,b) &< f_{xx}(a,b)f_{yy}(a,b) \end{aligned}$$

Since f_{xy} is raised to an even power, it's nonnegative.

$$\begin{aligned} 0 &\leq f_{xy}^2(a,b) < f_{xx}(a,b)f_{yy}(a,b) \\ 0 &< f_{xx}(a,b)f_{yy}(a,b) \end{aligned}$$

This tells us that $f_{xx}(a,b)$ and $f_{yy}(a,b)$ have the same sign – either they're both positive or they're both negative. So, the function's concavity is the same whether we hold the x -value or the y -value constant. The function might have the same concavity in all directions – unlike the saddle point example we saw above. So, it seems plausible that critical points with positive discriminants are local extrema, rather than saddle points.

3. Suppose the surface has a local maximum at (a,b) .

Holding $y = b$ constant, we can think of $z = f(x,b)$ as a one-variable function, in which case $f_{xx}(a,b) \leq 0$ by the single-variable second derivative test.

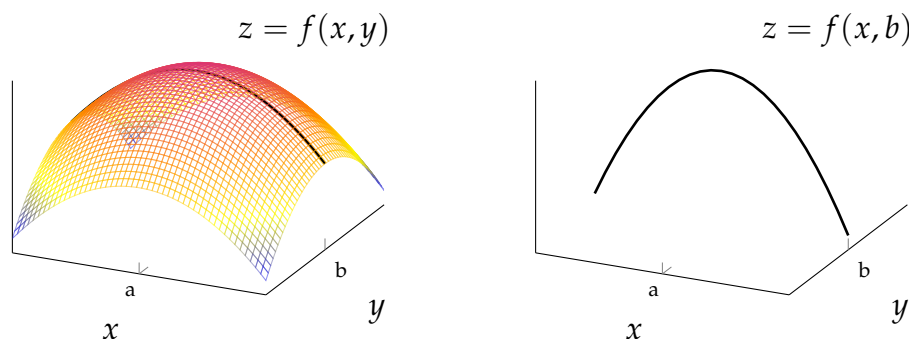

This doesn't go so far as to show us that $D(a,b) \geq 0$, but it does accord with the test of $f_{xx}(a,b)$ in the second bullet point of Theorem 16.1.14.

4. Similarly, suppose the surface has a local minimum at (a,b) .

Holding $y = b$ constant, we can think of $z = f(x,b)$ as a one-variable function, in which case $f_{xx}(a,b) \geq 0$ by the single-variable second derivative test.

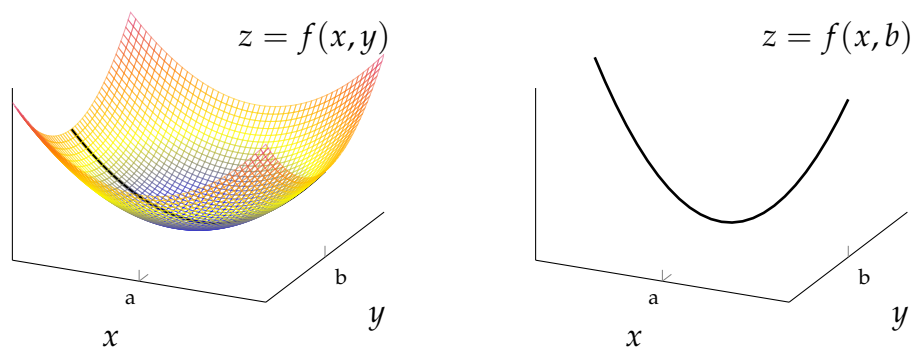

Again, although this doesn't go so far as to show us that $D(a, b) \geq 0$, it does accord with the test of $f_{xx}(a, b)$ in the first bullet point of Theorem 16.1.14.

Example 16.1.15

You might wonder why, in the local maximum/local minimum cases of Theorem 16.1.14, $f_{xx}(a, b)$ appears rather than $f_{yy}(a, b)$. The answer is only that x is before y in the alphabet⁹. You can use $f_{yy}(a, b)$ just as well as $f_{xx}(a, b)$. The reason is that if $D(a, b) > 0$ (as in the first two bullets of the theorem), then because $D(a, b) = f_{xx}(a, b)f_{yy}(a, b) - f_{xy}(a, b)^2 > 0$, we necessarily have $f_{xx}(a, b)f_{yy}(a, b) > 0$ so that $f_{xx}(a, b)$ and $f_{yy}(a, b)$ must have the same sign — either both are positive or both are negative.

You might also wonder why we cannot draw any conclusions when $D(a, b) = 0$ and what happens then. The second derivative test for functions of two variables was derived in precisely the same way as the second derivative test for functions of one variable is derived — you approximate the function by a polynomial that is of degree two in $(x - a)$, $(y - b)$ and then you analyze the behaviour of the quadratic polynomial near (a, b) . For this to work, the contributions to $f(x, y)$ from terms that are of degree two in $(x - a)$, $(y - b)$ had better be bigger than the contributions to $f(x, y)$ from terms that are of degree three and higher in $(x - a)$, $(y - b)$ when $(x - a)$, $(y - b)$ are really small. If this is not the case, for example when the terms in $f(x, y)$ that are of degree two in $(x - a)$, $(y - b)$ all have coefficients that are exactly zero, the analysis will certainly break down. That's exactly what happens when $D(a, b) = 0$. Here are some examples. The functions

$$f_1(x, y) = x^4 + y^4 \quad f_2(x, y) = -x^4 - y^4 \quad f_3(x, y) = x^3 + y^3 \quad f_4(x, y) = x^4 - y^4$$

all have $(0, 0)$ as the only critical point and all have $D(0, 0) = 0$. The first, f_1 has its minimum there. The second, f_2 , has its maximum there. The third and fourth have a saddle point there.

Here are sketches of some level curves for each of these four functions (with all renamed to simply f).

9 The shackles of convention are not limited to mathematics. Election ballots often have the candidates listed in alphabetic order.

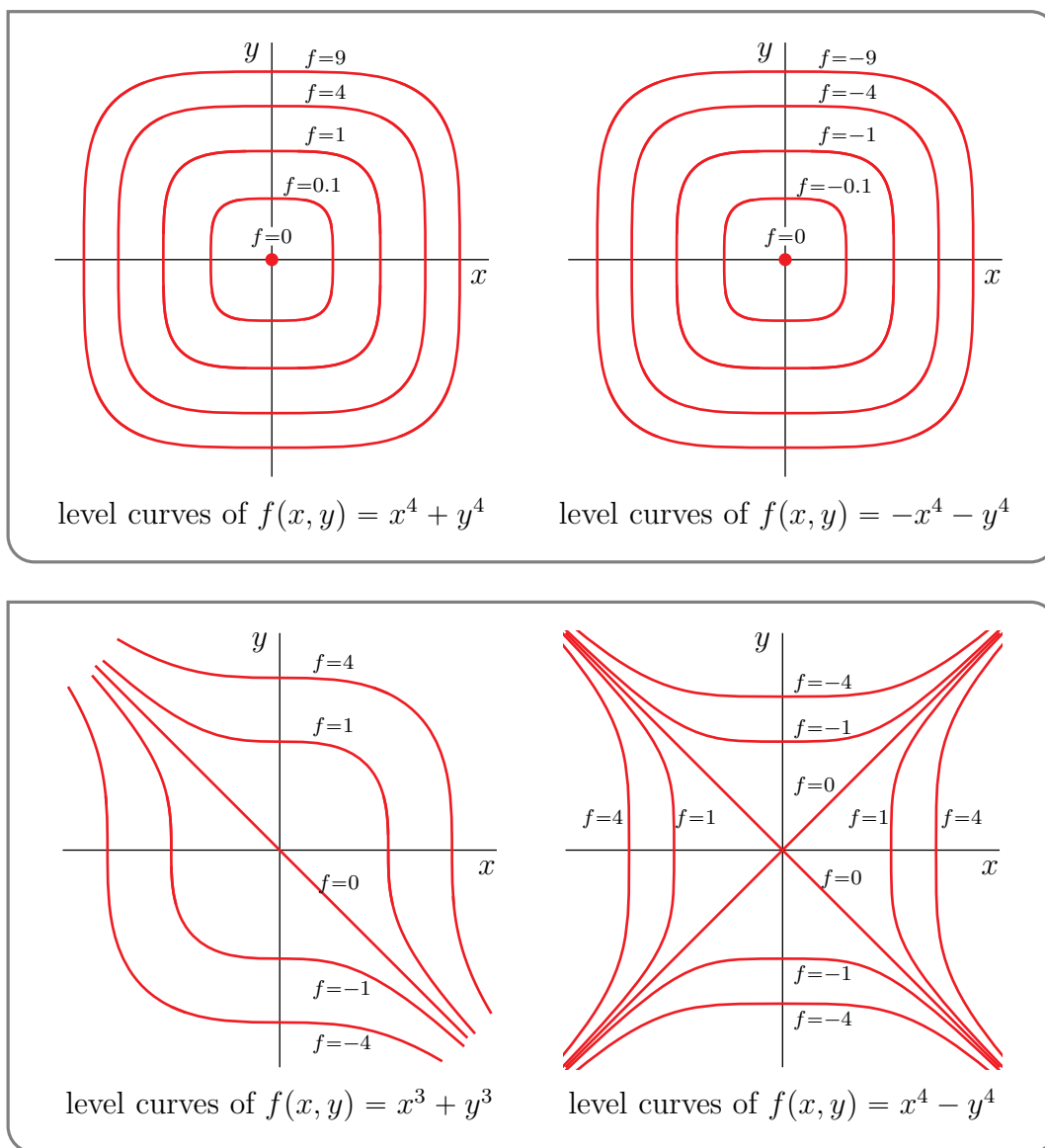

Example 16.1.16 ($f(x, y) = 2x^3 - 6xy + y^2 + 4y$)

Find and classify all critical points of $f(x, y) = 2x^3 - 6xy + y^2 + 4y$.

Solution. Thinking a little way ahead, to find the critical points we will need the first order partial derivatives. To apply the second derivative test of Theorem 16.1.14 we will need all second order partial derivatives. So we need all partial derivatives of order up to two. Here they are.

$$\begin{aligned}
 f &= 2x^3 - 6xy + y^2 + 4y \\
 f_x &= 6x^2 - 6y & f_{xx} &= 12x & f_{xy} &= -6 \\
 f_y &= -6x + 2y + 4 & f_{yy} &= 2 & f_{yx} &= -6
 \end{aligned}$$

(Of course, f_{xy} and f_{yx} have to be the same. It is still useful to compute both, as a way to catch some mechanical errors.)

We have already found, in Example 16.1.7, that the critical points are $(1, 1)$, $(2, 4)$. The classification is

critical point	$f_{xx}f_{yy} - f_{xy}^2$	f_{xx}	type
(1, 1)	$12 \times 2 - (-6)^2 < 0$		saddle point
(2, 4)	$24 \times 2 - (-6)^2 > 0$	24	local min

We were able to leave the f_{xx} entry in the top row blank, because

- we knew that $f_{xx}(1, 1)f_{yy}(1, 1) - f_{xy}^2(1, 1) < 0$, and
- we knew, from Theorem 16.1.14, that $f_{xx}(1, 1)f_{yy}(1, 1) - f_{xy}^2(1, 1) < 0$, by itself, was enough to ensure that (1, 1) was a saddle point.

Here is a sketch of some level curves of our $f(x, y)$. They are not needed to answer this question,

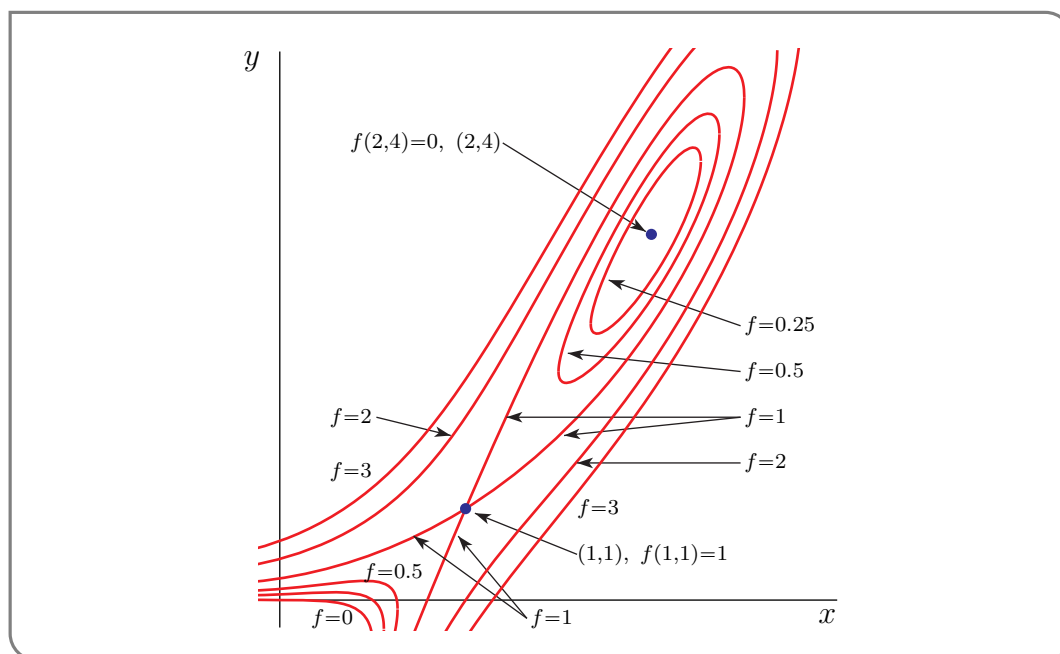

but can give you some idea as to what the graph of f looks like.

Example 16.1.16

Example 16.1.17 ($f(x, y) = xy(5x + y - 15)$)

Find and classify all critical points of $f(x, y) = xy(5x + y - 15)$.

Solution. We have already computed the first order partial derivatives

$$f_x(x, y) = y(10x + y - 15) \quad f_y(x, y) = x(5x + 2y - 15)$$

of $f(x, y)$ in Example 16.1.8. Again, to classify the critical points we need the second order partial derivatives. They are

$$\begin{aligned} f_{xx}(x, y) &= 10y \\ f_{yy}(x, y) &= 2x \\ f_{xy}(x, y) &= (1)(10x + y - 15) + y(1) = 10x + 2y - 15 \\ f_{yx}(x, y) &= (1)(5x + 2y - 15) + x(5) = 10x + 2y - 15 \end{aligned}$$

(Once again, we have computed both f_{xy} and f_{yx} to guard against mechanical errors.) We have already found, in Example 16.1.8, that the critical points are $(0,0)$, $(0,15)$, $(3,0)$ and $(1,5)$. The classification is

critical point	$f_{xx}f_{yy} - f_{xy}^2$	f_{xx}	type
$(0,0)$	$0 \times 0 - (-15)^2 < 0$		saddle point
$(0,15)$	$150 \times 0 - 15^2 < 0$		saddle point
$(3,0)$	$0 \times 6 - 15^2 < 0$		saddle point
$(1,5)$	$50 \times 2 - 5^2 > 0$	50	local min

Here is a sketch of some level curves of our $f(x,y)$. f is negative in the shaded regions and f is positive in the unshaded regions. Again this is not needed to answer this question, but can give you

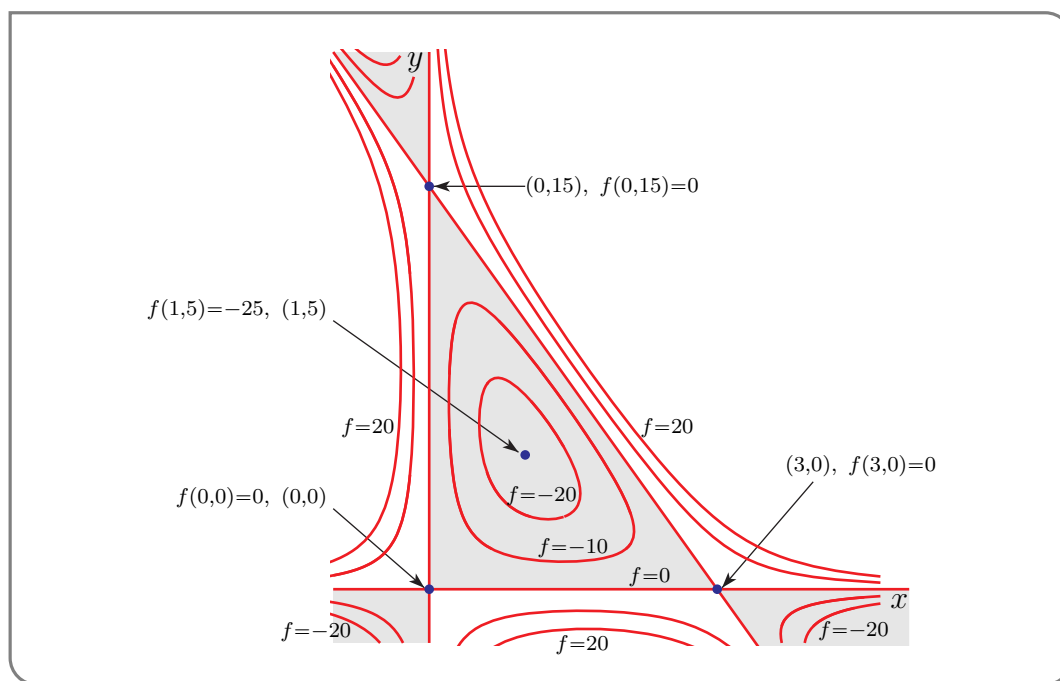

some idea as to what the graph of f looks like.

Example 16.1.17

Example 16.1.18

Find and classify all of the critical points of $f(x,y) = x^3 + xy^2 - 3x^2 - 4y^2 + 4$.

Solution. We know the drill now. We start by computing all of the partial derivatives of f up to order 2.

$$f = x^3 + xy^2 - 3x^2 - 4y^2 + 4$$

$$f_x = 3x^2 + y^2 - 6x$$

$$f_y = 2xy - 8y$$

$$f_{xx} = 6x - 6$$

$$f_{yy} = 2x - 8$$

$$f_{xy} = 2y$$

$$f_{yx} = 2y$$

f_x and f_y are defined everywhere. So the critical points are then the solutions of $f_x = 0$, $f_y = 0$. That is

$$f_x = 3x^2 + y^2 - 6x = 0 \quad (\text{E1})$$

$$f_y = 2y(x - 4) = 0 \quad (\text{E2})$$

The second equation, $2y(x - 4) = 0$, is satisfied if and only if at least one of the two equations $y = 0$ and $x = 4$ is satisfied.

- When $y = 0$, equation (E1) forces x to obey

$$0 = 3x^2 + 0^2 - 6x = 3x(x - 2)$$

so that $x = 0$ or $x = 2$.

- When $x = 4$, equation (E1) forces y to obey

$$0 = 3 \times 4^2 + y^2 - 6 \times 4 = 24 + y^2$$

which is impossible.

So, there are two critical points: $(0, 0)$, $(2, 0)$. Here is a table that classifies the critical points.

critical point	$f_{xx}f_{yy} - f_{xy}^2$	f_{xx}	type
$(0, 0)$	$(-6) \times (-8) - 0^2 > 0$	$-6 < 0$	local max
$(2, 0)$	$6 \times (-4) - 0^2 < 0$		saddle point

Example 16.1.18

Example 16.1.19

A manufacturer wishes to make an open rectangular box of given volume V using the least possible material. Find the design specifications.

Solution. Denote by x , y and z , the length, width and height, respectively, of the box.

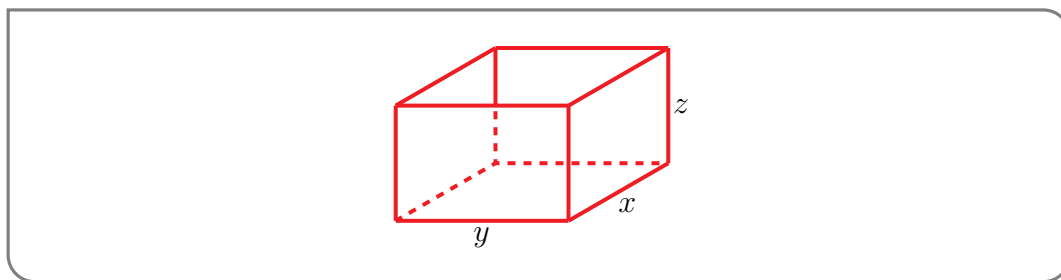

The box has two sides of area xz , two sides of area yz and a bottom of area xy . So the total surface area of material used is

$$S = 2xz + 2yz + xy$$

However the three dimensions x , y and z are not independent. The requirement that the box have volume V imposes the constraint

$$xyz = V$$

We can use this constraint to eliminate one variable. Since z is at the end of the alphabet (poor z), we eliminate z by substituting $z = \frac{V}{xy}$. Note that if x (or y) is equal to zero then the volume of the box would equal zero. What is the point of a box with zero volume?! So if we assume the box has non-zero volume then $x \neq 0$ and $y \neq 0$. So we have find the values of x and y that minimize the function

$$S(x, y) = \frac{2V}{y} + \frac{2V}{x} + xy$$

Let's start by finding the critical points of S . Since

$$S_x(x, y) = -\frac{2V}{x^2} + y$$

$$S_y(x, y) = -\frac{2V}{y^2} + x$$

Note that the partial derivatives are not defined for $(x, y) = (0, 0)$ but we have already eliminated the case where x or y is equal to zero. So (x, y) is a critical point if and only if

$$x^2y = 2V \tag{E1}$$

$$xy^2 = 2V \tag{E2}$$

Solving (E1) for y gives $y = \frac{2V}{x^2}$. Substituting this into (E2) gives

$$x \frac{4V^2}{x^4} = 2V \implies x^3 = 2V \implies x = \sqrt[3]{2V} \quad \text{and} \quad y = \frac{2V}{(2V)^{2/3}} = \sqrt[3]{2V}$$

As there is only one critical point, we would expect it to give the minimum¹⁰. But let's use the second derivative test to verify that at least the critical point is a local minimum. The various second partial derivatives are

$$S_{xx}(x, y) = \frac{4V}{x^3} \qquad S_{xx}(\sqrt[3]{2V}, \sqrt[3]{2V}) = 2$$

$$S_{xy}(x, y) = 1 \qquad S_{xy}(\sqrt[3]{2V}, \sqrt[3]{2V}) = 1$$

$$S_{yy}(x, y) = \frac{4V}{y^3} \qquad S_{yy}(\sqrt[3]{2V}, \sqrt[3]{2V}) = 2$$

So

$$S_{xx}(\sqrt[3]{2V}, \sqrt[3]{2V}) S_{yy}(\sqrt[3]{2V}, \sqrt[3]{2V}) - S_{xy}(\sqrt[3]{2V}, \sqrt[3]{2V})^2 = 3 > 0 \qquad S_{xx}(\sqrt[3]{2V}, \sqrt[3]{2V}) = 2 > 0$$

and, by Theorem 16.1.14.b, $(\sqrt[3]{2V}, \sqrt[3]{2V})$ is a local minimum and the desired dimensions are

$$x = y = \sqrt[3]{2V} \qquad z = \sqrt[3]{\frac{V}{4}}$$

10 Indeed one can use the facts that $0 < x < \infty$, that $0 < y < \infty$, and that $S \rightarrow \infty$ as $x \rightarrow 0$ and as $y \rightarrow 0$ and as $x \rightarrow \infty$ and as $y \rightarrow \infty$ to prove that the single critical point gives the global minimum.

Note that our solution has $x = y$. That's a good thing — the function $S(x, y)$ is symmetric in x and y . Because the box has no top, the symmetry does not extend to z .

Example 16.1.19

16.2 ▲ Absolute minima and maxima

Learning Objectives

- Reduce a constrained optimization problem in 3D, where the constraint is a single function (possibly with endpoints, possibly not), to a single-variable calculus problem.
- Understand that the global extrema of a two-variable function over a closed region occur along the boundary and/or at critical points of the interior
- Find the extreme values for a function of two variables on a closed region in cases where optimization on the boundary can be reduced to a single-variable calculus problem.

Of course a local maximum or minimum of a function need not be the absolute maximum or minimum. We'll now consider how to find the absolute maximum and minimum. Let's start by reviewing how one finds the absolute maximum and minimum of a function of one variable on an interval.

For concreteness, let's suppose that we want to find the extremal¹¹ values of a function $f(x)$ on the interval $0 \leq x \leq 1$. If an extremal value is attained at some $x = a$ which is in the interior of the interval, i.e. if $0 < a < 1$, then a is also a local maximum or minimum and so has to be a critical point of f . But if an extremal value is attained at a boundary point a of the interval, i.e. if $a = 0$ or $a = 1$, then a need not be a critical point of f . This happens, for example, when $f(x) = x$. The largest value of $f(x)$ on the interval $0 \leq x \leq 1$ is 1 and is attained at $x = 1$, but $f'(x) = 1$ is never zero, so that f has no critical points.

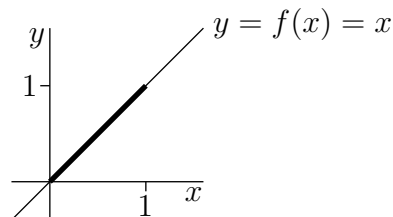

So to find the maximum and minimum of the function $f(x)$ on the interval $[0, 1]$, you:

1. build up a list of all candidate points $0 \leq a \leq 1$ at which the maximum or minimum could be attained, by finding all a 's for which either

¹¹ Recall that “extremal value” means “either maximum value or minimum value”.

- (a) $0 < a < 1$ and $f'(a)$ does not exist or
 - (b) $0 < a < 1$ and $f'(a) = 0$ or
 - (c) a is a boundary point, i.e. $a = 0$ or $a = 1$;
2. and then you evaluate $f(a)$ at each a on the list of candidates. The biggest of these candidate values of $f(a)$ is the absolute maximum and the smallest of these candidate values is the absolute minimum.

The procedure for finding the maximum and minimum of a function of two variables $f(x, y)$ in a set like, for example, the unit disk $x^2 + y^2 \leq 1$, is similar. You again:

1. build up a list of all candidate points (a, b) in the set at which the maximum or minimum could be attained, by finding all (a, b) 's for which either¹²
 - (a) (a, b) is in the interior of the set and $f_x(a, b)$ or $f_y(a, b)$ does not exist or
 - (b) (a, b) is in the interior of the set (for our example, $a^2 + b^2 < 1$) and $f_x(a, b) = f_y(a, b) = 0$ or
 - (c) (a, b) is a boundary¹³ point, (for our example, $a^2 + b^2 = 1$), and could give the maximum or minimum on the boundary — more about this shortly —
2. and then you evaluate $f(a, b)$ at each (a, b) on the list of candidates. The biggest of these candidate values of $f(a, b)$ is the absolute maximum and the smallest of these candidate values is the absolute minimum.

The boundary of a set in \mathbb{R}^2 (like $x^2 + y^2 \leq 1$) is a curve (like $x^2 + y^2 = 1$). This curve is a one dimensional set, meaning that it is like a deformed x -axis. We can find the maximum and minimum of $f(x, y)$ on this curve by converting $f(x, y)$ into a function of one variable (on the curve) and using the standard function of one variable techniques. This is best explained by some examples.

Example 16.2.1

Find the maximum and minimum values of $f(x, y) = x^3 + xy^2 - 3x^2 - 4y^2 + 4$ on the disk $x^2 + y^2 \leq 1$.

Solution. Again, we first find all critical points, and then we analyze the boundary.

Interior: If f takes its maximum or minimum value at a point in the interior, $x^2 + y^2 < 1$, then that point must be a critical point of f . To find the critical points¹⁴ we compute the first order derivatives.

$$f_x = 3x^2 + y^2 - 6x \quad f_y = 2xy - 8y$$

These are polynomials (in two variables) and they are defined everywhere. So the critical points are the solutions of

$$f_x = 3x^2 + y^2 - 6x = 0 \tag{E1}$$

$$f_y = 2y(x - 4) = 0 \tag{E2}$$

¹² This is probably a good time to review the statement of Theorem 16.1.2.

¹³ It should intuitively obvious from a sketch that the boundary of the disk $x^2 + y^2 \leq 1$ is the circle $x^2 + y^2 = 1$. But if you really need a formal definition, here it is. A point (a, b) is on the boundary of a set S if there is a sequence of points in S that converges to (a, b) and there is also a sequence of points in the complement of S that converges to (a, b) .

¹⁴ We actually found the critical points in Example 16.1.18. But, for the convenience of the reader, we'll repeat that here.

The second equation, $2y(x - 4) = 0$, is satisfied if and only if at least one of the two equations $y = 0$ and $x = 4$ is satisfied.

- When $y = 0$, equation (E1) forces x to obey

$$0 = 3x^2 + 0^2 - 6x = 3x(x - 2)$$

so that $x = 0$ or $x = 2$.

- When $x = 4$, equation (E1) forces y to obey

$$0 = 3 \times 4^2 + y^2 - 6 \times 4 = 24 + y^2$$

which is impossible.

So, there are only two critical points: $(0,0)$, $(2,0)$.

Boundary: Our boundary is $x^2 + y^2 = 1$. We know that (x,y) satisfies $x^2 + y^2 = 1$, and hence $y^2 = 1 - x^2$. Examining the formula for $f(x,y)$, we see that it contains only even¹⁵ powers of y , so we can eliminate y by substituting $y^2 = 1 - x^2$ into the formula.

$$f = x^3 + x(1 - x^2) - 3x^2 - 4(1 - x^2) + 4 = x + x^2$$

The max and min of $x + x^2$ for $-1 \leq x \leq 1$ must occur either

- when $x = -1$ ($\Rightarrow y = f = 0$) or
- when $x = +1$ ($\Rightarrow y = 0, f = 2$) or
- when $0 = \frac{d}{dx}(x + x^2) = 1 + 2x$ (so $x = -\frac{1}{2}$, $y = \pm\sqrt{\frac{3}{4}}$, $f = -\frac{1}{4}$).

Here is a sketch showing all of the points that we have identified.

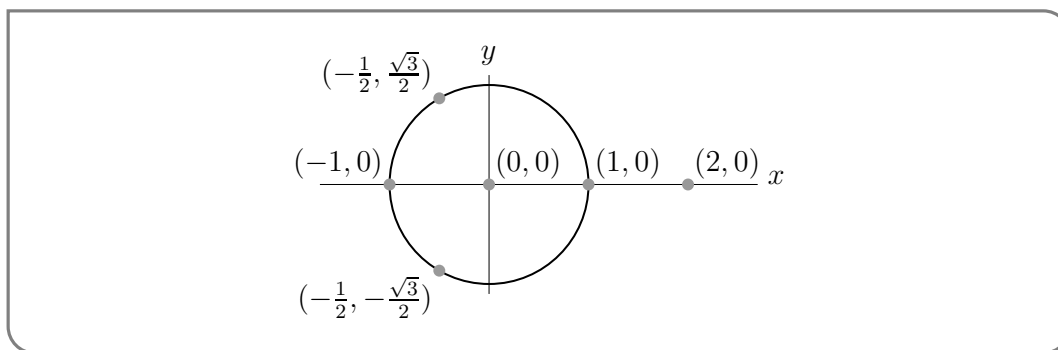

Note that the point $(2,0)$ is outside the allowed region¹⁶. So all together, we have the following candidates for max and min, with the max and min indicated.

point	$(0,0)$	$(-1,0)$	$(1,0)$	$(-\frac{1}{2}, \pm\frac{\sqrt{3}}{2})$
value of f	4	2	0	$-\frac{1}{4}$
	max			min

Example 16.2.1

15 If it contained odd powers too, we could consider the cases $y \geq 0$ and $y \leq 0$ separately and substitute $y = \sqrt{1 - x^2}$ in the former case and $y = -\sqrt{1 - x^2}$ in the latter case.

16 We found $(2,0)$ as a solution to the critical point equations (E1), (E2). That's because, in the course of solving those equations, we ignored the constraint that $x^2 + y^2 \leq 1$.

Example 16.2.2

Find the maximum and minimum values of $f(x, y) = xy - x^3y^2$ when (x, y) runs over the square $0 \leq x \leq 1$, $0 \leq y \leq 1$.

Solution. As usual, let's examine the critical points and boundary in turn.

Interior: If f takes its maximum or minimum value at a point in the interior, $0 < x < 1$, $0 < y < 1$, then that point must be a critical point of f . To find the critical points we compute the first order derivatives.

$$f_x(x, y) = y - 3x^2y^2 \quad f_y(x, y) = x - 2x^3y$$

Again, these functions are polynomials in two variables and they are smooth everywhere in their domain, so the first order partial derivatives exist everywhere in the interior. This means that the critical points are the solutions of

$$\begin{aligned} f_x = 0 &\iff y(1 - 3x^2y) = 0 &\iff y = 0 \text{ or } 3x^2y = 1 \\ f_y = 0 &\iff x(1 - 2x^2y) = 0 &\iff x = 0 \text{ or } 2x^2y = 1 \end{aligned}$$

- If $y = 0$, we cannot have $2x^2y = 1$, so we must have $x = 0$.
- If $3x^2y = 1$, we cannot have $x = 0$, so we must have $2x^2y = 1$. Dividing gives $1 = \frac{3x^2y}{2x^2y} = \frac{3}{2}$ which is impossible.

So the only critical point in the square is $(0, 0)$. There $f = 0$. *Boundary:* The region is a square, so its boundary consists of its four sides.

- First, we look at the part of the boundary with $x = 0$. On that entire side $f = 0$.
- Next, we look at the part of the boundary with $y = 0$. On that entire side $f = 0$.
- Next, we look at the part of the boundary with $y = 1$. There $f = f(x, 1) = x - x^3$. To find the maximum and minimum of $f(x, y)$ on the part of the boundary with $y = 1$, we must find the maximum and minimum of $x - x^3$ when $0 \leq x \leq 1$.

Recall that, in general, the maximum and minimum of a function $h(x)$ on the interval $a \leq x \leq b$, must occur either at $x = a$ or at $x = b$ or at an x for which either $h'(x) = 0$ or $h'(x)$ does not exist. In this case, $\frac{d}{dx}(x - x^3) = 1 - 3x^2$, so the max and min of $x - x^3$ for $0 \leq x \leq 1$ must occur

- either at $x = 0$, where $f = 0$,
- or at $x = \frac{1}{\sqrt{3}}$, where $f = \frac{2}{3\sqrt{3}}$,
- or at $x = 1$, where $f = 0$.

- Finally, we look at the part of the boundary with $x = 1$. There $f = f(1, y) = y - y^2$. As $\frac{d}{dy}(y - y^2) = 1 - 2y$, the only critical point of $y - y^2$ is at $y = \frac{1}{2}$. So the max and min of $y - y^2$ for $0 \leq y \leq 1$ must occur

- either at $y = 0$, where $f = 0$,
- or at $y = \frac{1}{2}$, where $f = \frac{1}{4}$,
- or at $y = 1$, where $f = 0$.

All together, we have the following candidates for max and min, with the max and min indicated.

point	$(0,0)$	$(0,0 \leq y \leq 1)$	$(0 \leq x \leq 1,0)$	$(1,0)$	$(1, \frac{1}{2})$	$(1,1)$	$(0,1)$	$(\frac{1}{\sqrt{3}}, 1)$
value of f	0	0	0	0	$\frac{1}{4}$	0	0	$\frac{2}{3\sqrt{3}} \approx 0.385$
	min	min	min	min		min	min	max

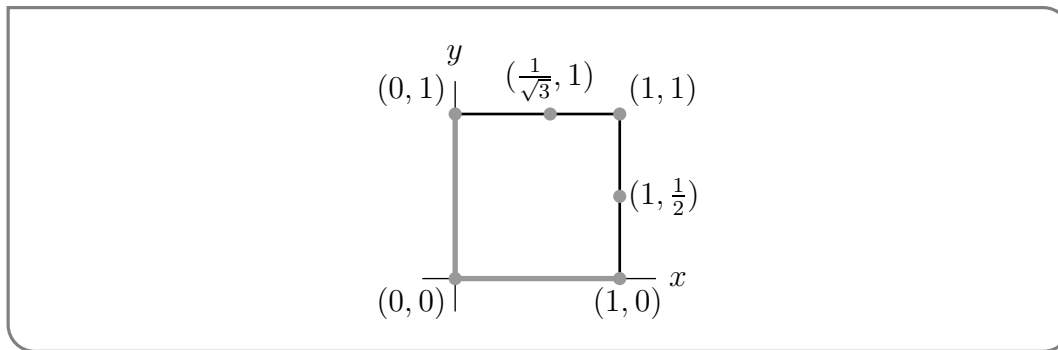

Example 16.2.2

Warning 16.2.3 (Checking Entire Boundaries).

A common misconception when students are first learning about “checking boundaries” is that the absolute extrema will occur on the “corners” of the boundaries. In the example we just finished, Example 16.2.2, the four corners of our square boundary were indeed points we needed to check. But if we had *only* checked the corners, we wouldn’t have found the absolute maximum.

In your homework, if you notice that the extrema often occur at “corners” of boundaries, or at point with x or y equal to 0, you should not take this to be a general rule.

To really see why corners don’t need to be important, consider the image¹⁷ below of an area northeast of UBC. The central body of water in the image is Indian Arm. Indian Arm extends into the ocean, so its elevation is pretty close to sea level. If we’re thinking of the z axis as height above sea level, the surface of Indian Arm is probably the *global minimum height* in the rectangular region shown. So, the global minimum along the boundary is *not* at a corner. It’s somewhere in the middle of the left vertical boundary segment.

17 image generated by Natural Resources Canada’s [Atlas of Canada - Toporama](#) and shared under the [open government license](#)

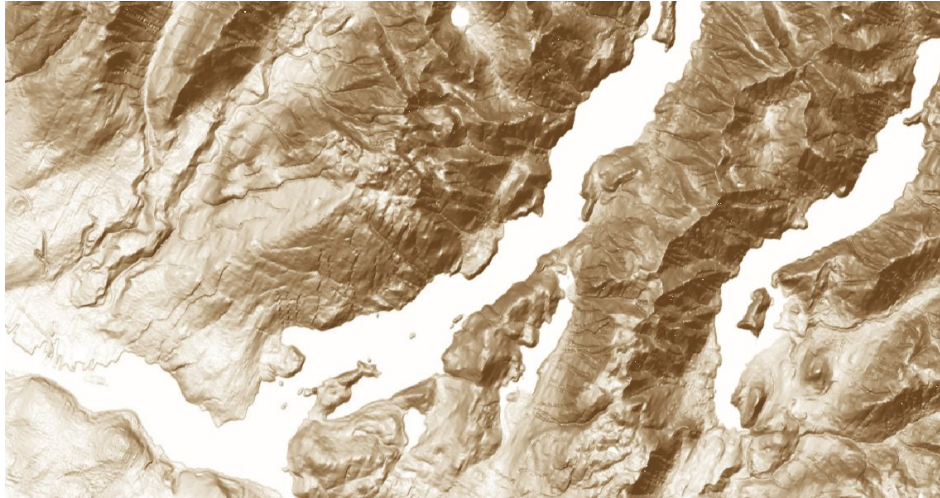

Similarly, looking at the mountains in the image, there's no reason to imagine the absolute highest point along the boundary must specifically happen at a *corner*.

Example 16.2.4

Find the high and low points of the surface $z = \sqrt{x^2 + y^2}$ with (x, y) varying over the square $|x| \leq 1$, $|y| \leq 1$.

Solution. The function $f(x, y) = \sqrt{x^2 + y^2}$ has a particularly simple geometric interpretation — it is the distance from the point (x, y) to the origin. So

- the minimum of $f(x, y)$ is achieved at the point in the square that is nearest the origin — namely the origin itself. So $(0, 0, 0)$ is the lowest point on the surface and is at height 0.
- The maximum of $f(x, y)$ is achieved at the points in the square that are farthest from the origin — namely the four corners of the square $(\pm 1, \pm 1)$. At those four points $z = \sqrt{2}$. So the highest points on the surface are $(\pm 1, \pm 1, \sqrt{2})$.

Even though we have already answered this question, it will be instructive to see what we would have found if we had followed our usual protocol. The partial derivatives of $f(x, y) = \sqrt{x^2 + y^2}$ are defined for $(x, y) \neq (0, 0)$ and are

$$f_x(x, y) = \frac{x}{\sqrt{x^2 + y^2}} \quad f_y(x, y) = \frac{y}{\sqrt{x^2 + y^2}}$$

- As we mentioned above, at the point $(x, y) = (0, 0)$ the partial derivatives are not defined. But $(0, 0)$ is inside the interior of the domain of our function. Therefore, $(0, 0)$ is a critical point.
- There are no other critical points because
 - $f_x = 0$ only for $x = 0$, and
 - $f_y = 0$ only for $y = 0$.
 - So $(0, 0)$ is the only critical point because f_x and f_y are not defined there.
- The boundary of the square consists of its four sides. One side is

$$\{ (x, y) \mid x = 1, -1 \leq y \leq 1 \}$$

On this side $f = \sqrt{1+y^2}$. As $\sqrt{1+y^2}$ increases with $|y|$, the smallest value of f on that side is 1 (when $y = 0$) and the largest value of f is $\sqrt{2}$ (when $y = \pm 1$). The same thing happens on the other three sides. The maximum value of f is achieved at the four corners. Note that f_x and f_y are both nonzero at all four corners.

Example 16.2.4

Example 16.2.5 (Disconnecting a Complete Graph)

In graph theory, a *complete graph* is a collection of n vertices (visualized as dots), every pair of which is connected by an edge (visualized as lines). The complete graphs on 10 vertices and on 30 vertices are shown below.

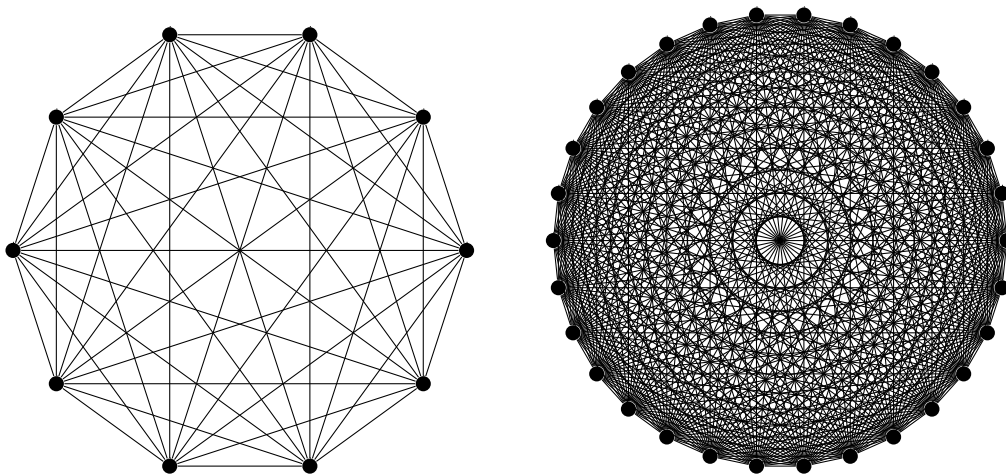

Suppose you start with the complete graph on 30 vertices. You delete edges (but not vertices) one-by-one until the graph is broken into three parts. Every part has at least one vertex (otherwise it wouldn't be a part, it would be a nothing) and there are no edges between vertices of different parts. Some possibilities are shown below to demonstrate.

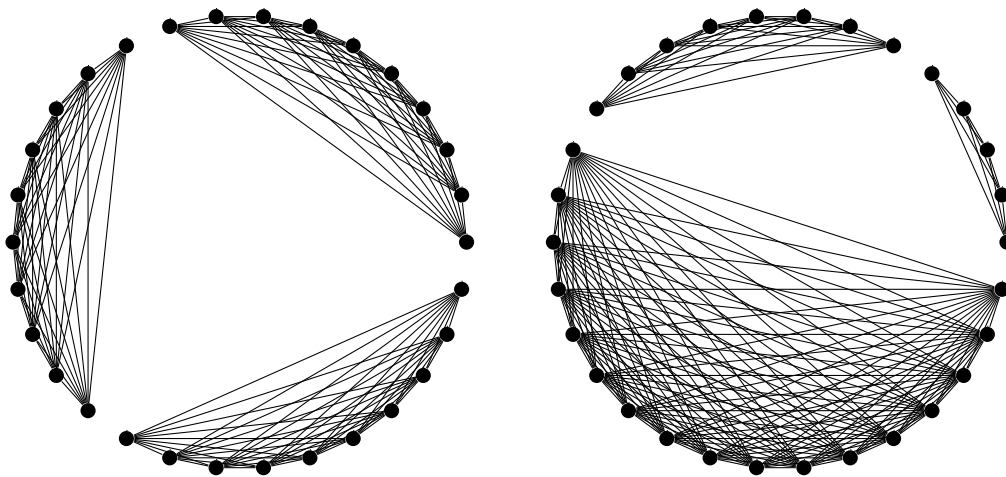

What is the minimum number of edges you could have deleted, in order to break the graph into three pieces?

Solution. Let's name the pieces $X, Y,$ and $W,$ and say the numbers of vertices they contain are $x, y,$ and $w,$ respectively. Then $x \geq 1, y \geq 1, w \geq 1,$ and $x + y + w = 30.$

For every vertex in one piece of the broken graph, you must have deleted the edges connecting it to every vertex in every other piece. So, to delete all the edges from X to $Y,$ you deleted at least xy edges; to delete all the edges from X to $W,$ you deleted at least xw edges; and to delete all the edges from Y to $W,$ you deleted at least yw edges. So all together, you deleted at least this many edges:

$$xy + xw + yw$$

Since $x + y + w = 30,$ we can eliminate one of these from our expression, and say the minimum number of edges deleted was:

$$\begin{aligned} f(x, y) &= xy + x(30 - x - y) + y(30 - x - y) \\ &= 30x + 30y - x^2 - xy - y^2 \end{aligned}$$

The domain of this function is all integer pairs in the region bounded by $x \geq 1, y \geq 1,$ and $x + y \leq 29.$

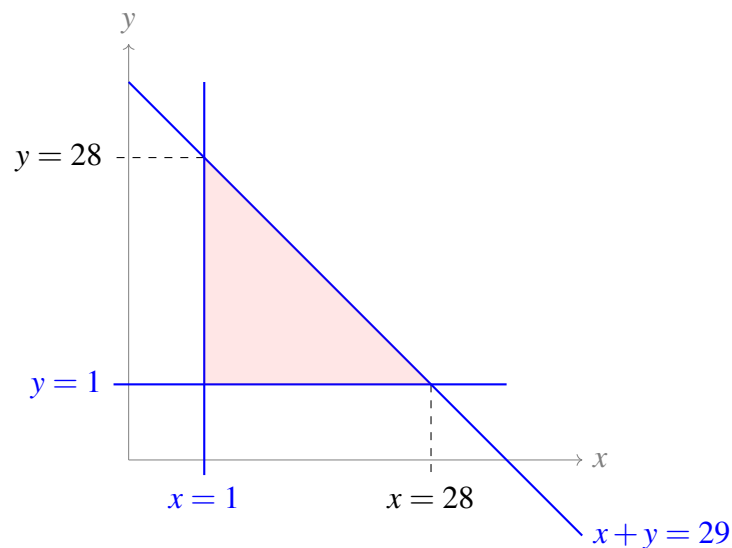

To find the minimum value of $f(x, y)$ in this region, we should check for critical points, and check all three boundary lines.

- First, let's check for critical points.

$$\begin{aligned} f(x, y) &= 30x + 30y - x^2 - xy - y^2 \\ f_x &= 30 - 2x - y & f_y &= 30 - 2y - x \end{aligned}$$

Solving $f_x = 0$ for $y,$ we find $y = 30 - 2x.$ Plugging into the equation $f_y = 0,$ we get:

$$\begin{aligned} 0 &= f_y = 30 - 2(30 - 2x) - x \\ &= 3x - 30 \\ x &= 10 \\ y &= 30 - 2x = 10 \end{aligned}$$

So, our only critical point is $(10, 10),$ and this is inside our region.

$$f(10, 10) = 300 + 300 - 100 - 100 - 100 = 300$$

- Second, let's check the boundary line $y = 1$, $1 \leq x \leq 28$. On this portion of the boundary:

$$\begin{aligned} f(x,y) &= 30x + 30y - x^2 - xy - y^2 \\ &= 30x + 30 - x - x - 1 \\ &= 28x + 29 \end{aligned}$$

This is an increasing function, so its minimum will be at the smallest value of x in our interval: $x = 1$.

$$f(1,1) = 57$$

- Third, we check the boundary line $x = 1$, $1 \leq y \leq 28$. On this portion of the boundary:

$$\begin{aligned} f(x,y) &= 30x + 30y - x^2 - xy - y^2 \\ &= 30 + 30y - 1 - y - y \\ &= 28y + 29 \end{aligned}$$

This is an increasing function, so its minimum will be at the smallest value of y in our interval: $y = 1$.

$$f(1,1) = 57$$

- Fourth, we check the final boundary line, $y = 29 - x$, $1 \leq x \leq 28$. On this portion of the boundary:

$$\begin{aligned} f(x,y) &= 30x + 30y - x^2 - xy - y^2 \\ &= 30x + 30(29 - x) - x^2 - x(29 - x) - (29 - x)^2 \\ &= -x^2 + 29x + 29 \end{aligned}$$

The one-variable function $g(x) = -x^2 + 29x + 29$ is a parabola pointing down, so its minimum will occur at an endpoint of our interval: $x = 1$ or $x = 28$.

$$f(1,28) = 57 \quad f(28,1) = 57$$

Comparing the values from the four bullet points, we find the minimum number of edges we could have deleted in order to break the complete graph into 3 pieces is 57. We achieve that minimum by having two pieces of one vertex each, and the remaining piece with all other vertices.

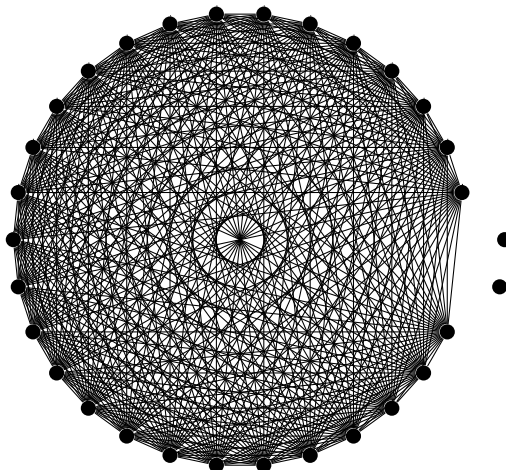

Remark 1: making use of sketching and symmetry can reduce the amount of work involved in solving this problem. If we recognize that $f(x, y)$ is a paraboloid opening down, then we know its critical point will actually be an absolute max – not the minimum we’re looking for.

We can see the x and y are symmetric in $f(x, y)$ and in our region, so we also could have checked only the boundary $x = 1$, and not the boundary $y = 1$, understanding that their minimum values would be the same.

Remark 2: Our model domain for this problem actually restricts x and y to whole-number values, as opposed to real numbers. We showed that 57 was the minimum value of $f(x, y)$ over all *real* numbers in the sketched region. Since whole numbers are themselves reals, and the minimum occurred at integer value of x and y (i.e. the minimum is in our model domain), we can be sure that 57 is the minimum over all whole numbers in our domain. If the minimum had occurred at, say $x = \frac{1}{2}$ and $y = \frac{1}{2}$, then it wouldn’t have been in our model domain – and this would be a problem for a different course!

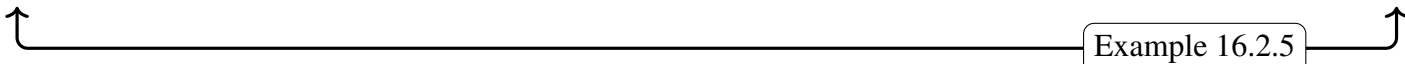

Example 16.2.5

16.3 ▲ The method of Lagrange multipliers

Learning Objectives

- Understand that solutions to a particular system of equations correspond to points along a curve that is locally flat.
- Use the method of Lagrange multipliers to find extrema along a constraint.
- Choose between the method of Lagrange multipliers, and simple plugging in, for determining extrema along a constraint.
- Find the absolute extrema of a surface over a closed region, using the appropriate method (Lagrange or plugging in) for investigating the boundary.

In the last section we had to solve a number of problems of the form “What is the maximum value of the function f on the curve C ?” In those examples, the curve C was simple enough that we could reduce the problem to finding the maximum of a function of one variable. For more complicated problems this reduction might not be possible. In this section, we introduce another method for solving such problems. First some nomenclature.

Definition 16.3.1.

A problem of the form

“Find the maximum and minimum values of the function $f(x,y)$ for (x,y) on the curve $g(x,y) = 0$.”

is one type of *constrained optimization* problem. The function being maximized or minimized, $f(x,y)$, is called the *objective function*. The function, $g(x,y)$, whose zero set is the curve of interest, is called the *constraint function*.

Such problems are quite common. As we said above, we have already encountered them in the last section on absolute maxima and minima, when we were looking for the extreme values of a function on the boundary of a region. In economics “utility functions” are used to model the relative “usefulness” or “desirability” or “preference” of various economic choices. For example, a utility function $U(w, \kappa)$ might specify the relative level of satisfaction a consumer would get from purchasing a quantity w of wine and κ of coffee. If the consumer wants to spend \$100 and wine costs \$20 per unit and coffee costs \$5 per unit, then the consumer would like to maximize $U(w, \kappa)$ subject to the constraint that $20w + 5\kappa = 100$.

To this point we have always solved such constrained optimization problems by solving $g(x,y) = 0$ for y as a function of x (or for x as a function of y). However, quite often the function $g(x,y)$ is so complicated that one cannot explicitly solve $g(x,y) = 0$ for y as a function of x or for x as a function of y and one also cannot explicitly parametrize $g(x,y) = 0$. Or sometimes you can, for example, solve $g(x,y) = 0$ for y as a function of x , but the resulting solution is so complicated that it is really hard, or even virtually impossible, to work with. Direct attacks become even harder in higher dimensions when, for example, we wish to optimize a function $f(x,y,z)$ subject to a constraint $g(x,y,z) = 0$.

There is another procedure called the method of “Lagrange¹⁸ multipliers” that comes to our rescue in these scenarios. Here is the two-dimensional version of the method. There are obvious analogues in other dimensions.

16.3.1 ►► Motivation for the method

First, some intuition. When we talk about derivatives on a surface, we need to think about the derivatives in a particular direction.¹⁹ Consider in particular the surface formed by all points (x,y) such that $f(x,y) = z$, for some function $f(x,y)$. The directions giving zero rate of increase are those that keep you on a level curve. Those directions are perpendicular to $\nabla f(a,b)$.

The corresponding statement in three dimensions is that $\nabla F(a,b,c)$ is perpendicular to the level surface $F(x,y,z) = F(a,b,c)$ at (a,b,c) . Hence a good way to find a vector normal to the surface $F(x,y,z) = 0$ at the point (a,b,c) is to compute the gradient $\nabla F(a,b,c)$.

18 Joseph-Louis Lagrange was actually born Giuseppe Lodovico Lagrangia in Turin, Italy in 1736. He moved to Berlin in 1766 and then to Paris in 1786. He eventually acquired French citizenship and then the French claimed he was a French mathematician, while the Italians continued to claim that he was an Italian mathematician.

19 If you’re walking along hilly terrain, changing direction can cause you to change from going uphill to downhill. Direction definitely matters!

Theorem 16.3.2 (Lagrange Multipliers).

Let $f(x, y, z)$ and $g(x, y, z)$ have continuous first partial derivatives in a region of \mathbb{R}^3 that contains the surface S given by the equation $g(x, y, z) = 0$. Further assume that $\nabla g(x, y, z) \neq \mathbf{0}$ on S .

If f , restricted to the surface S , has a local extreme value at the point (a, b, c) on S , then there is a real number λ such that

$$\nabla f(a, b, c) = \lambda \nabla g(a, b, c)$$

that is

$$f_x(a, b, c) = \lambda g_x(a, b, c)$$

$$f_y(a, b, c) = \lambda g_y(a, b, c)$$

$$f_z(a, b, c) = \lambda g_z(a, b, c)$$

The number λ is called a *Lagrange multiplier*.

Proof. Suppose that (a, b, c) is a point of S and that $f(x, y, z) \geq f(a, b, c)$ for all points (x, y, z) on S that are close to (a, b, c) . That is (a, b, c) is a local minimum for f on S . Of course the argument for a local maximum is virtually identical.

Imagine that we go for a walk on S , with the time t running, say, from $t = -1$ to $t = +1$ and that at time $t = 0$ we happen to be exactly at (a, b, c) . Let's say that our position is $(x(t), y(t), z(t))$ at time t . Write

$$F(t) = f(x(t), y(t), z(t))$$

So $F(t)$ is the value of f that we see on our walk at time t . Then for all t close to 0, $(x(t), y(t), z(t))$ is close to $(x(0), y(0), z(0)) = (a, b, c)$ so that

$$F(0) = f(x(0), y(0), z(0)) = f(a, b, c) \leq f(x(t), y(t), z(t)) = F(t)$$

for all t close to zero. So $F(t)$ has a local minimum at $t = 0$ and consequently $F'(0) = 0$.

By the multivariable chain rule,

$$\begin{aligned} F'(0) &= \left. \frac{d}{dt} f(x(t), y(t), z(t)) \right|_{t=0} \\ &= f_x(a, b, c)x'(0) + f_y(a, b, c)y'(0) + f_z(a, b, c)z'(0) = 0 \end{aligned} \quad (*)$$

We may rewrite this as a dot product:

$$\begin{aligned} 0 &= F'(0) = \nabla f(a, b, c) \cdot [x'(0), y'(0), z'(0)] \\ &\implies \nabla f(a, b, c) \perp [x'(0), y'(0), z'(0)] \end{aligned}$$

This is true for all paths on S that pass through (a, b, c) at time 0. In particular it is true for all vectors $[x'(0), y'(0), z'(0)]$ that are tangent to S at (a, b, c) . So $\nabla f(a, b, c)$ is perpendicular to S at (a, b, c) .

But we already know that $\nabla g(a, b, c)$ is also perpendicular to S at (a, b, c) . So $\nabla f(a, b, c)$ and $\nabla g(a, b, c)$ have to be parallel vectors. That is,

$$\nabla f(a, b, c) = \lambda \nabla g(a, b, c)$$

for some number λ . That's the Lagrange multiplier rule of our theorem. \square

16.3.2 ▶▶ Using the method

Theorem 16.3.3 (Lagrange Multipliers).

Let $f(x,y)$ and $g(x,y)$ have continuous first partial derivatives in a region of \mathbb{R}^2 that contains the surface S given by the equation $g(x,y) = 0$. Further assume that $g(x,y)$ has no critical points on S .

If f , restricted to the surface S , has a local extreme value at the point (a,b) on S , then there is a real number λ such that

$$f_x(a,b) = \lambda g_x(a,b)$$

$$f_y(a,b) = \lambda g_y(a,b)$$

The number λ is called a *Lagrange multiplier*.

So to find the maximum and minimum values of $f(x,y)$ on a surface $g(x,y) = 0$, assuming that both the objective function $f(x,y)$ and constraint function $g(x,y)$ have continuous first partial derivatives, and that $g(x,y)$ has no critical points, you

1. build up a list of candidate points (x,y,z) by finding all solutions to the equations

$$f_x(x,y) = \lambda g_x(x,y)$$

$$f_y(x,y) = \lambda g_y(x,y)$$

$$g(x,y) = 0$$

Note that there are three equations and three unknowns, namely x , y , and λ .

2. Then you evaluate $f(x,y)$ at each (x,y) on the list of candidates. The biggest of these candidate values is the absolute maximum, if an absolute maximum exists. The smallest of these candidate values is the absolute minimum, if an absolute minimum exists..

Theorem 16.3.3 can be extended to functions of more variables in a natural way. Using higher-dimensional Lagrange isn't in our learning goals, but for interest, we want you to see how easily the method generalizes. The calculus is the same – it's only the algebra that gets longer.

Theorem 16.3.4 ((Optional) Lagrange Multipliers for Functions of Three Variables).

Let $f(x, y, z)$ and $g(x, y, z)$ have continuous first partial derivatives in a region of \mathbb{R}^3 that contains the surface S given by the equation $g(x, y, z) = 0$. Further assume that $g(x, y, z)$ has no critical points on S .

If f , restricted to the surface S , has a local extreme value at the point (a, b, c) on S , then there is a real number λ such that

$$f_x(a, b, c) = \lambda g_x(a, b, c)$$

$$f_y(a, b, c) = \lambda g_y(a, b, c)$$

$$f_z(a, b, c) = \lambda g_z(a, b, c)$$

The number λ is called a *Lagrange multiplier*.

Now for a bunch of examples.

Example 16.3.5

Find the maximum and minimum of the function $x^2 - 10x - y^2$ on the ellipse whose equation is $x^2 + 4y^2 = 16$.

Solution. For this first example, we'll do out the algebra in truly gory detail. Once you get the hang of it, it'll go much faster.

Our objective function (the one we want to maximize and/or minimize) is $f(x, y) = x^2 - 10x - y^2$ and the constraint function is $g(x, y) = x^2 + 4y^2 - 16$. To apply the method of Lagrange multipliers we start by computing the first-order derivatives of these functions.

$$f_x = 2x - 10 \quad f_y = -2y \quad g_x = 2x \quad g_y = 8y$$

So, according to the method of Lagrange multipliers, we need to find all solutions to the following system of equations.

$$f_x = \lambda g_x \qquad 2x - 10 = \lambda(2x) \qquad \text{(E1)}$$

$$f_y = \lambda g_y \qquad \implies \qquad -2y = \lambda(8y) \qquad \text{(E2)}$$

$$g(x, y) = 0 \qquad x^2 + 4y^2 - 16 = 0 \qquad \text{(E3)}$$

(E1) In equation (E1), if $2x$ is nonzero, then we can divide both sides of the equation by it, to find $\lambda = \frac{2x-10}{2x}$, i.e. $\lambda = \frac{x-5}{x}$. If $2x = 0$, then the equation becomes $-10 = 0\lambda$, which is not true for any λ .

(E2) In equation (E2), if $8y$ is nonzero, then we can divide both sides of the equation by it, to find $\lambda = \frac{-2y}{8y}$, i.e. $\lambda = -\frac{1}{4}$. If $8y = 0$, then we also get a solution $y = 0$ for any λ .

(E1)+(E2) We need all three equations to be true at the same time (that is, for the same values of x , y , and λ). We've found two ways for both (E1) and (E2) to be true.

- First way: $\lambda = \frac{x-5}{x}$ and $\lambda = -\frac{1}{4}$
- Second way: $\lambda = \frac{x-5}{x}$ and $y = 0$

(E3) Now we'll see which points make (E1) and (E2) true while *also* making (E3) true.

- First way: $\lambda = \frac{x-5}{x}$ and $\lambda = -\frac{1}{4}$

$$\begin{aligned} \lambda &= \frac{x-5}{x} \text{ and } \lambda = -\frac{1}{4} \\ \implies \frac{x-5}{x} &= -\frac{1}{4} \\ \implies -4x + 20 &= x \\ \implies x &= 4 \end{aligned}$$

In order to satisfy (E3):

$$\begin{aligned} 0 &= 4^2 + 4y^2 - 16 \\ 0 &= y \end{aligned}$$

So, the point $(x, y) = (4, 0)$ satisfies all three equations.

- Second way: $\lambda = \frac{x-5}{x}$ and $y = 0$. If $y = 0$, then from E3, we see

$$\begin{aligned} 0 &= x^2 + 4 \cdot 0^2 - 16 \\ 16 &= x^2 \\ x &= \pm 4 \end{aligned}$$

So the points to consider are $(x, y) = (\pm 4, 0)$.

Now we've found the only possible solutions to all three equations: $(\pm 4, 0)$. (λ has to exist, but we don't actually care what it is.) So the method of Lagrange multipliers, Theorem 16.3.3, gives that the only possible locations of the maximum and minimum of the function f are $(4, 0)$ and $(-4, 0)$. To complete the problem, we only have to compute f at those points.

point	$(4, 0)$	$(-4, 0)$
value of f	-24	56
	min	max

Hence the maximum value of $x^2 - 10x - y^2$ on the ellipse is 56 and the minimum value is -24 .

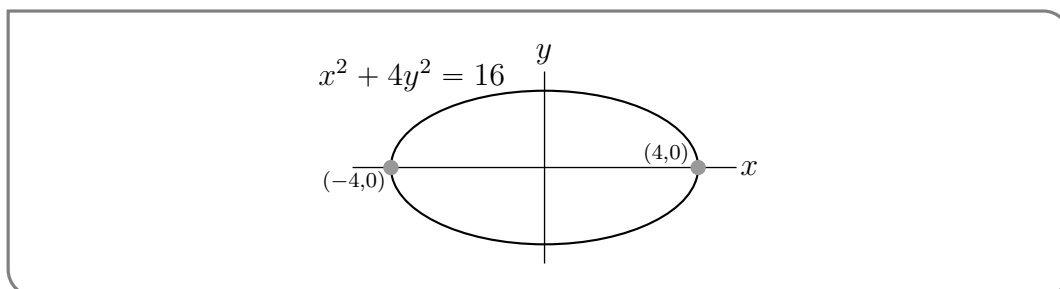

Example 16.3.5

In the previous example, we had to make a lot of decisions about how to solve for the solutions to the system of three equations. Actually, we can start our Lagrange system-solving the same way every time. The first observation we make is that the partial derivatives of g can be 0, or nonzero. If they're zero, this may or may not lead to a solution; if they're nonzero, this tells us something about λ .

In the textbook and problem book, we will consistently use the same method to solve the system of equations. It's certainly not the only way, and you are free to use other methods. Once you get used to the computations, you'll probably start finding ways to make them faster based on the specifics of individual problems.

Example 16.3.6 (Solving Lagrange in General)

Suppose you want to find all points (x, y) for which a solution exists to the system below.

$$f_x = \lambda g_x \quad (\text{E1})$$

$$f_y = \lambda g_y \quad (\text{E2})$$

$$g(x, y) = 0 \quad (\text{E3})$$

where λ is some real constant. Our method below will hinge on the observation from the last example that we get different solutions for zero vs. nonzero partial derivatives of the constraint.

- If $g_x \neq 0$ and $g_y \neq 0$, then from (E1) we see $\lambda = \frac{f_x}{g_x}$, and from (E2) we see $\lambda = \frac{f_y}{g_y}$. So, choosing a pair (x, y) such that

$$\frac{f_x}{g_x} = \frac{f_y}{g_y}$$

means that for some λ , that pair makes (E1) and (E2) true. Simplify the equation above to find the necessary relationship between x and y , then find which pairs with that relationship make (E3) true.

- If $g_x = 0$, then from (E1) we see also $f_x = 0$. Then (E1) is true for any λ that we like. We can check that there exists some λ that makes (E2) true as well. Then, we find the points (x, y) that make (E3) true as well as $g_x = f_x = 0$.
- If $g_y = 0$, then from (E2) we see also $f_y = 0$. Then (E2) is true for any λ that we like. We can check that there exists some λ that makes (E1) true as well. Then, we find the points (x, y) that make (E3) true as well as $g_y = f_y = 0$.

Sometimes, one or more of these cases won't lead to any solutions. In Example 16.3.5, we were immediately able to discard the possibility $g_x = 0$, because it didn't lead to a solution. Once you're practiced with these types of problems, you'll often see quite quickly which cases you get to discard.

Example 16.3.6

We'll apply our three-case breakdown in subsequent examples.

Example 16.3.7

Find the minimum and maximum values of the objective function

$$f(x, y) = \ln(x^2 - 2x + 5) + \ln(y^2 - 4y + 13)$$

subject to the constraint

$$x^2 - 2x + y^2 - 4y = 20$$

Solution. Our constraint function is

$$g(x, y) = x^2 - 2x + y^2 - 4y - 20 = 0$$

We start by setting up the first two equations from the method of Lagrange multipliers.

$$f_x = \lambda g_x \qquad \frac{2x-2}{x^2-2x+5} = \lambda(2x-2) \qquad \text{(E1)}$$

$$f_y = \lambda g_y \qquad \frac{2y-4}{y^2-4y+13} = \lambda(2y-4) \qquad \text{(E2)}$$

$$g(x, y) = 0 \qquad x^2 - 2x + y^2 - 4y = 20 \qquad \text{(E3)}$$

Now we consider our three cases.

- $g_x \neq 0$ and $g_y \neq 0$. From (E1), this means $\lambda = \frac{1}{x^2-2x+5}$. From (E2), $\lambda = \frac{1}{y^2-4y+13}$.

$$\begin{aligned} \frac{1}{x^2-2x+5} &= \frac{1}{y^2-4y+13} \\ x^2-2x+5 &= y^2-4y+13 \\ x^2-2x &= y^2-4y+8 \end{aligned}$$

This gives us the relationship between x and y that must hold for (E1) and (E2) to be true under the assumption $g_x \neq 0$ and $g_y \neq 0$. Now, in order for (E3) to be true as well:

$$\begin{aligned} 0 &= (x^2 - 2x) + y^2 - 4y - 20 \\ &= (y^2 - 4y + 8) + y^2 - 4y - 20 \\ &= 2y^2 - 8y - 12 \\ 0 &= y^2 - 4y - 6 \\ y &= \frac{4 \pm \sqrt{16 - 4(1)(-6)}}{2} = \frac{4 \pm \sqrt{40}}{2} = 2 \pm \sqrt{10} \\ \text{So, } 0 &= (x^2 - 2x) + y^2 - 4y - 20 \\ &= x^2 - 2x + (2 \pm \sqrt{10})^2 - 4(2 \pm \sqrt{10}) - 20 \\ &= x^2 - 2x + (4 \pm 4\sqrt{10} + 10) - 8 \mp 4\sqrt{10} - 20 \end{aligned}$$

Note $\pm 4\sqrt{2} \mp 4\sqrt{2} = 0$

$$\begin{aligned} &= x^2 - 2x + 4 + 10 - 8 - 20 \\ &= x^2 - 2x - 14 \\ x &= \frac{2 \pm \sqrt{4 - 4(-14)}}{2} = \frac{2 \pm 2\sqrt{15}}{2} = 1 \pm \sqrt{15} \end{aligned}$$

This gives us four points to consider:

$$(1 + \sqrt{15}, 2 + \sqrt{10}), (1 - \sqrt{15}, 2 + \sqrt{10}), (1 + \sqrt{15}, 2 - \sqrt{10}), \text{ and } (1 - \sqrt{15}, 2 - \sqrt{10}).$$

- If $g_x = 0$, then $x = 1$, and (E1) is true for any λ . Then we can choose whatever λ is necessary to make (E2) true. By (E3):

$$\begin{aligned} 0 &= x^2 - 2x + y^2 - 4y - 20 \\ &= 1 - 2 + y^2 - 4y - 20 \\ &= y^2 - 4y - 21 \\ &= (y - 7)(y + 3) \\ y &= 7, \quad y = -3 \end{aligned}$$

This gives us two points to consider: $(1, 7)$ and $(1, -3)$.

- If $g_y = 0$, then $y = 2$, and (E2) is true for any λ . Then we can choose whatever λ is necessary to make (E1) true. By (E3):

$$\begin{aligned} 0 &= x^2 - 2x + y^2 - 4y - 20 \\ &= x^2 - 2x + 4 - 8 - 20 \\ &= x^2 - 2x - 24 \\ &= (x - 6)(x + 4) \\ x &= 6, \quad x = -4 \end{aligned}$$

This gives us two points to consider: $(-4, 2)$ and $(6, 2)$.

So, all together we have eight points that satisfy our three Lagrange equations. It's left only to decide which of those points lead to maxima and to minima.

point	$(1 + \sqrt{15}, 2 + \sqrt{10})$	$(1 - \sqrt{15}, 2 + \sqrt{10})$	$(1 + \sqrt{15}, 2 - \sqrt{10})$	$(1 - \sqrt{15}, 2 - \sqrt{10})$
value of f	$\ln 361$	$\ln 361$	$\ln 361$	$\ln 361$
	max	max	max	max

point	$(-4, 2)$	$(6, 2)$	$(1, 7)$	$(1, -3)$
value of f	$\ln 261$	$\ln 261$	$\ln 136$	$\ln 136$
			min	min

Our maximum value is $\ln 361$, and our minimum value is $\ln 136$.

Example 16.3.7

Example 16.3.8

Find the ends of the major and minor axes of the ellipse $3x^2 - 2xy + 3y^2 = 4$. They are the points on the ellipse that are farthest from and nearest to the origin.

Solution. Let (x, y) be a point on $3x^2 - 2xy + 3y^2 = 4$. This point is at the end of a major axis when it maximizes its distance from the centre of the ellipse, $(0, 0)$. It is at the end of a minor axis when it minimizes its distance from $(0, 0)$. So we wish to maximize and minimize the distance $\sqrt{x^2 + y^2}$ subject to the constraint

$$g(x, y) = 3x^2 - 2xy + 3y^2 - 4 = 0$$

Now maximizing/minimizing $\sqrt{x^2 + y^2}$ is equivalent²⁰ to maximizing/minimizing its square $(\sqrt{x^2 + y^2})^2 = x^2 + y^2$. So we are free to choose the objective function

$$f(x, y) = x^2 + y^2$$

which we will do, because it makes the derivatives cleaner. Again, we use Lagrange multipliers to solve this problem, so we start by finding the partial derivatives.

$$f_x(x, y) = 2x \quad f_y(x, y) = 2y \quad g_x(x, y) = 6x - 2y \quad g_y(x, y) = -2x + 6y$$

We need to find all solutions to

$$2x = \lambda(6x - 2y) \tag{E1}$$

$$2y = \lambda(-2x + 6y) \tag{E2}$$

$$3x^2 - 2xy + 3y^2 - 4 = 0 \tag{E3}$$

- If $g_x \neq 0$ and $g_y \neq 0$, then $\lambda = \frac{2x}{6x-2y} = \frac{x}{3x-y}$ by (E1), and $\lambda = \frac{2y}{-2x+6y} = \frac{y}{-x+3y}$ by (E2).

$$\begin{aligned} \frac{x}{3x-y} &= \frac{y}{-x+3y} \\ -x^2 + 3xy &= 3xy - y^2 \\ x^2 &= y^2 \\ x &= \pm y \end{aligned}$$

So if $x = \pm y$, then the appropriate λ will make both (E1) and (E2) true. Now let's see what makes (E3) true.

$$4 = 3x^2 - 2xy + 3y^2$$

$$4 = 3(\pm y)^2 - 2(\pm y)y + 3y^2$$

$$= 3y^2 \mp 2y^2 + 3y^2$$

$$= (6 \mp 2)y^2$$

$$4 = (6 + 2)x^2 \quad \implies \quad x = \pm \frac{1}{\sqrt{2}} \text{ when } x = -y$$

$$4 = (6 - 2)x^2 \quad \implies \quad x = \pm 1 \text{ when } x = y$$

20 The function $S(z) = z^2$ is a strictly increasing function for $z \geq 0$. So, for $a, b \geq 0$, the statement " $a < b$ " is equivalent to the statement " $S(a) < S(b)$ ".

This gives us four points to check: the two points $\pm\left(\frac{1}{\sqrt{2}}, -\frac{1}{\sqrt{2}}\right)$ and the two points $\pm(1, 1)$

- If $g_x = 0$, then $6x - 2y = 0$, i.e. $y = 3x$. By (E1), $x = 0$, so $y = 0$. Then (E3) doesn't hold, so this leads to no solutions.
- If $g_y = 0$, then $-2x + 6y = 0$, i.e. $x = 3y$. By (E2), $y = 0$, so $x = 0$. Then (E3) doesn't hold, so this leads to no solutions.

The distance from $(0,0)$ to $\pm(1,1)$, namely $\sqrt{2}$, is larger than the distance from $(0,0)$ to $\pm\left(\frac{1}{\sqrt{2}}, -\frac{1}{\sqrt{2}}\right)$, namely 1. So the ends of the minor axes are $\pm\left(\frac{1}{\sqrt{2}}, -\frac{1}{\sqrt{2}}\right)$ and the ends of the major axes are $\pm(1, 1)$. Those ends are sketched in the figure on the left below. Once we have the ends, it is an easy matter²¹ to sketch the ellipse as in the figure on the right below.

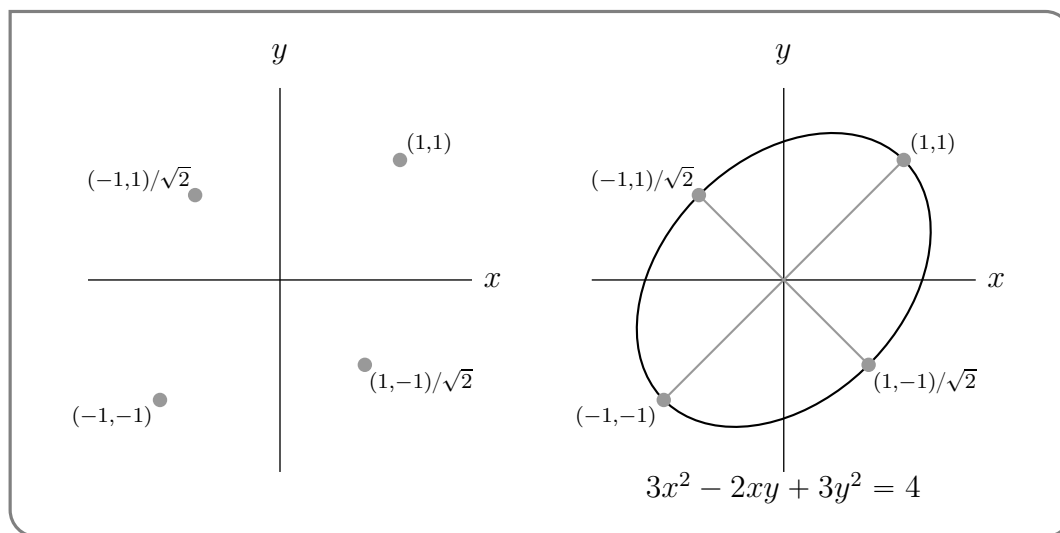

Example 16.3.8

In the previous examples, the objective function and the constraint were specified explicitly. That will not always be the case. In the next example, we have to do a little geometry to extract them.

Example 16.3.9

Find the rectangle of largest area (with sides parallel to the coordinates axes) that can be inscribed in the ellipse $x^2 + 2y^2 = 1$.

Solution. Since this question is so geometric, it is best to start by drawing a picture.

²¹ if you tilt your head so that the line through $(1, 1)$ and $(-1, -1)$ appears horizontal

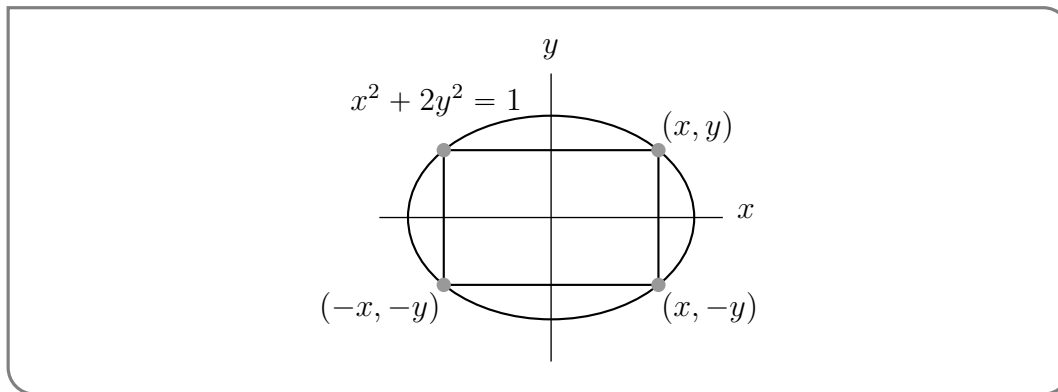

Call the coordinates of the upper right corner of the rectangle (x, y) , as in the figure above. Note that $x \geq 0$ and $y \geq 0$; and if $x = 0$ or $y = 0$, then the area of the rectangle is 0, which is certainly not a maximum. So the global maximum must occur at some point where x and y are both positive. This will also be a local maximum, so we should be able to find it using the method of Lagrange multipliers.

The four corners of the rectangle are $(\pm x, \pm y)$ so the rectangle has width $2x$ and height $2y$ and the objective function is $f(x, y) = 4xy$. The constraint function for this problem is $g(x, y) = x^2 + 2y^2 - 1$. Again, to use Lagrange multipliers we need the first order partial derivatives.

$$f_x = 4y \quad f_y = 4x \quad g_x = 2x \quad g_y = 4y$$

So, according to the method of Lagrange multipliers, we need to find all solutions to

$$4y = \lambda(2x) \tag{E1}$$

$$4x = \lambda(4y) \tag{E2}$$

$$x^2 + 2y^2 - 1 = 0 \tag{E3}$$

- If $g_x \neq 0$ and $g_y \neq 0$, then $\lambda = \frac{4y}{2x} = \frac{2y}{x}$ from (E1) and $\lambda = \frac{4x}{4y} = \frac{x}{y}$ from (E2). So,

$$\begin{aligned} \frac{2y}{x} &= \frac{x}{y} \\ 2y^2 &= x^2 \\ x &= (\pm\sqrt{2})y \end{aligned}$$

From (E3),

$$\begin{aligned} ((\pm\sqrt{2})y)^2 + 2y^2 - 1 &= 0 \\ 2y^2 + 2y^2 &= 1 \\ 4y^2 &= 1 \\ y &= \pm\frac{1}{2} \\ x &= (\pm\sqrt{2})y = \pm\frac{1}{\sqrt{2}} \end{aligned}$$

So there are four points to consider: $(\pm\frac{1}{\sqrt{2}}, \pm\frac{1}{2})$.

- If $g_x = 0$, i.e. $2x = 0$, then $x = 0$; by (E1) also $y = 0$; but then (E3) fails. So this doesn't give us any more points to consider.
- If $g_y = 0$, i.e. $4y = 0$, then $y = 0$; by (E2) also $x = 0$; but then (E3) fails. So this doesn't give us any more points to consider either.

We now have four possible values of (x,y) , namely $(1/\sqrt{2}, 1/2)$, $(-1/\sqrt{2}, -1/2)$, $(1/\sqrt{2}, -1/2)$ and $(-1/\sqrt{2}, 1/2)$. They are the four corners of a single rectangle. We said that we wanted (x,y) to be the upper right corner, i.e. the corner in the first quadrant. It is $(1/\sqrt{2}, 1/2)$.

How do we interpret the other three points we found? The global min of the function $4xy$ subject to the constraint $x^2 + 2y^2 = 1$ will occur at one of these points, but those points aren't in our model domain. When x and y have different signs, $4xy$ no longer gives the area of a rectangle, since it's negative. Over our model domain, we kind of have "endpoints:" $x = 0$ and $y = 0$. Our maximum occurred somewhere between our endpoints; our model minimum occurs at the endpoints.

Example 16.3.9

16.3.3 ►► Bounded vs unbounded Constraints

In the last example, we had to think a little extra about whether the solution to the Lagrange equations gave a maximum or minimum. Take a closer look at Theorem 16.3.3: all *local* extrema will occur at a solution point. So when do the solution points definitely also include all *absolute* extrema?

1. If our constraint function is a closed curve (circle, ellipse, square, etc.) and our objective function is continuous over it, then there will certainly be an absolute max and absolute min over the constraint; and these will certainly also be local extrema. So when our constraint is a closed curve, and our objective function is continuous over it, we are guaranteed that the absolute max and min exist, and are at points that satisfy the Lagrange equations.

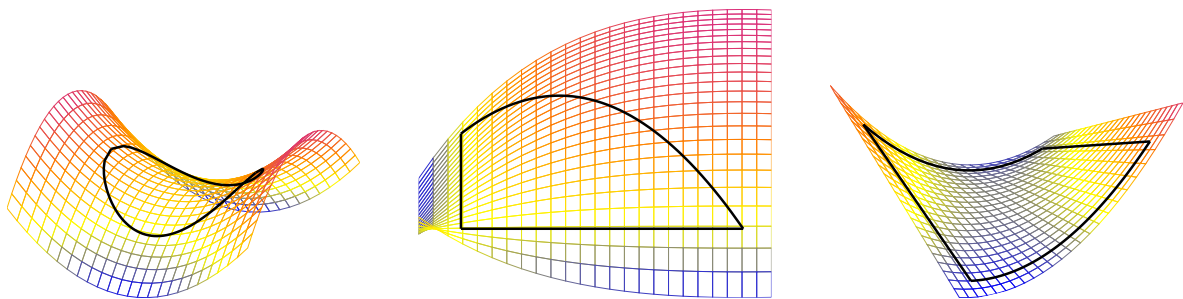

In Section 16.2 we considered domains that were bounded by a closed curve, so we only considered boundaries of this type.

2. If our constraint function is *not* a closed curve (e.g. a line, a line segment, a function like $xy = 1$, etc.) then the system is more complicated. Assume that the objective function is continuous over the constraint curve. Since our constraint curve is one-dimensional (like a line, but a line that has some orientation in space), we're in a similar position as we were in single-variable calculus: extrema can occur at endpoints, or at "critical points." In our case, "critical points" translate to solutions to the Lagrange equations; "endpoints" mean pretty much the same thing they always have.

- (a) If the constraint function is bounded, we must consider its endpoints as well as solutions to the Lagrange system. There will be an absolute maximum and minimum, and these will definitely occur at solutions to the Lagrange system *or* at the endpoints of the constraint.

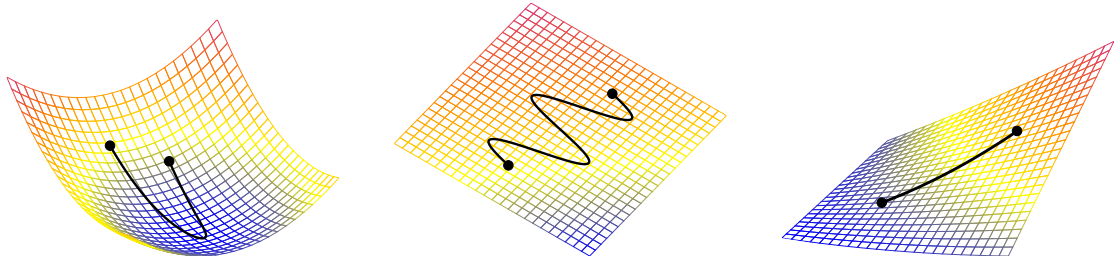

- (b) If the constraint function is unbounded, there may or may not exist absolute extrema. This is where you'll most heavily rely on your understanding of function shape and behaviour. Limits can be useful here.

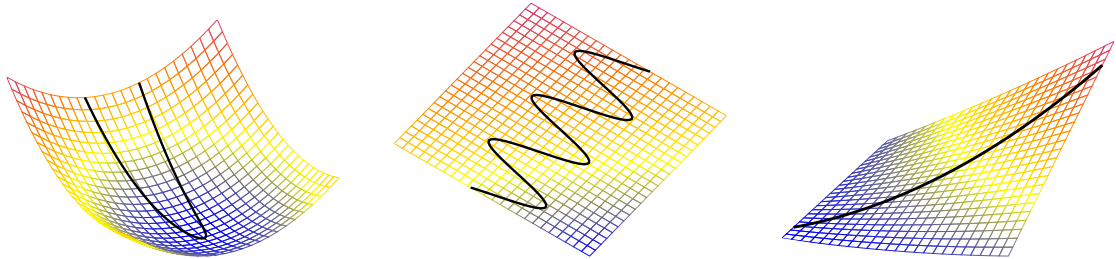

Example 16.3.10

Find the values of $w \geq 0$ and $\kappa \geq 0$ that maximize the utility function

$$U(w, \kappa) = 6w^{2/3}\kappa^{1/3} \quad \text{subject to the constraint} \quad 4w + 2\kappa = 12$$

Solution. The constraint $4w + 2\kappa = 12$ is simple enough that we can easily use it to express κ in terms of w , then substitute $\kappa = 6 - 2w$ into $U(w, \kappa)$, and then maximize $U(w, 6 - 2w) = 6w^{2/3}(6 - 2w)^{1/3}$ using the techniques of last semester.

However, for practice purposes, we'll use Lagrange multipliers with the objective function $U(w, \kappa) = 6w^{2/3}\kappa^{1/3}$ and the constraint function $g(w, \kappa) = 4w + 2\kappa - 12$. The first order derivatives of these functions are

$$U_w = 4w^{-1/3}\kappa^{1/3} \quad U_\kappa = 2w^{2/3}\kappa^{-2/3} \quad g_w = 4 \quad g_\kappa = 2$$

The boundary values ("endpoints") $w = 0$ and $\kappa = 0$ give utility 0, which is obviously not going to be the maximum utility. So it suffices to consider only local maxima. According to the method of Lagrange multipliers, we need to find all solutions to

$$4w^{-1/3}\kappa^{1/3} = 4\lambda \tag{E1}$$

$$2w^{2/3}\kappa^{-2/3} = 2\lambda \tag{E2}$$

$$4w + 2\kappa - 12 = 0 \tag{E3}$$

Then we see $g_x \neq 0$ and $g_w \neq 0$, so we only have one of our usual three cases.

- equation (E1) gives $\lambda = w^{-1/3}\kappa^{1/3}$.

- Substituting this into (E2) gives $w^{2/3}\kappa^{-2/3} = \lambda = w^{-1/3}\kappa^{1/3}$ and hence $w = \kappa$.
- Then substituting $w = \kappa$ into (E3) gives $6\kappa = 12$.

So $w = \kappa = 2$ and the maximum utility is $U(2,2) = 12$.

Note in this example we had a bounded (but not closed) curve. It has endpoints $(0,6)$ and $(3,0)$. Since the maximum didn't occur at the endpoints, then the global maximum was also a local maximum, and so it showed up as a solution to the system of Lagrange equations.

Example 16.3.10

Appendix

LIST OF LEARNING OBJECTIVES

Chapter 0: Introduction

- Solve a long question by breaking it up into smaller pieces.
- Apply mathematical concepts to models of physical processes.
- Apply concepts creatively to unfamiliar contexts.
- Be able to clearly and effectively communicate mathematical content in prose.
- Understand some basic ideas about what constitutes a proof in mathematics; understand the differences between how something is defined and how it is computed.
- Correctly and appropriately manipulate algebraic and trigonometric expressions: simplification, solving, etc.

Chapter 1: Power functions as building blocks

1.1: Power functions

- Sketch functions of the form $f(x) = x^n$, where n is a real number (power functions); interpret the shapes of power functions relative to one another.
- Determine which term in a polynomial function will dominate for small x and for large x .

1.2: First steps in graph sketching

- Sketch two-term polynomial functions by determining which term dominates for small x and for large x . For example, sketch $f(x) = x^2 - 3x^4$.

1.3: Rate of reaction

1.5: Familiar functions

- Know that e^x eventually dominates any given power function, and any power function with positive exponent dominates logarithm (for large positive x). Use these facts for sketching. For example, sketch $f(x) = e^x - x$.
- Sketch familiar functions such as e^x , $\log x$, $\sin x$, $\cos x$, $\tan x$, $1/x$, \sqrt{x} , and $|x|$.

Chapter 2: Limits**2.1: Quick review of limits**

- Explain using both words and pictures what $\lim_{x \rightarrow a} f(x) = L$, $\lim_{x \rightarrow a^-} f(x) = L$, and $\lim_{x \rightarrow a^+} f(x) = L$ mean (including the case where L is equal to ∞ or $-\infty$).
- Explain using both words and pictures what $\lim_{x \rightarrow \infty} f(x) = L$ and $\lim_{x \rightarrow -\infty} f(x) = L$ mean (including the case where L is equal to ∞ or $-\infty$).
- Find the limit of a function at a point given the graph of the function.
- Understand when limits do and do not exist.

2.2: Asymptotes

- Evaluate limits of polynomial, rational, trigonometric, exponential, and logarithmic functions.
- Explain using both informal language and the language of limits what it means for a function to have a horizontal or vertical asymptote.
- Given a simple function, find its vertical and horizontal asymptotes by asymptotic reasoning or by taking limits.
- Explain why it is not true that a function cannot cross its horizontal asymptote.

2.3: Limits and continuity

- Explain informally and formally what it means for a function to be continuous on its domain.
- Identify and classify points of discontinuity (jump, infinite, removable).
- Determine where a given function is continuous. Use formal notation as well as informal explanation.
- Given a function defined with parameters, select parameter values that make the function continuous.

Chapter 3: Introduction to the Derivative

3.1: Review: lines

- Given an equation for a line, sketch the line, and identify its slope.
- Describe negative / positive / zero slope as corresponding to a line that is decreasing / increasing / constant over an interval.
- Find a line from two points; from a point and a slope; or from a clearly labelled graph.
- Find the slope at various points of a piecewise-linear function

3.2: Slopes and rates of change

- Describe the slope of a linear function as the rate of change of that function (change in y over change in x).
- Compute the average rate of change of a nonlinear function over an interval.

3.3: The Derivative

- Explain using words, pictures, and the language of limits what a derivative is.
- Use the definition of derivative to find the tangent line to a function at a given point.
- Describe the tangent line as an approximation (the linear approximation) to a function at a given point.
- Describe the derivative of a function as a function itself.
- Given the graph of a function, sketch the graph of its derivative.
- Interpret derivatives as instantaneous rates of change
- Explain why the definition of a derivative is important, even if you know shortcuts for computation.

3.4: Higher order derivatives

- Understand what is meant by ‘higher-order derivatives,’ and compute them.

3.5: Derivatives of exponential functions

- Use the definition of the derivative to show that the derivative of the function $f(x) = a^x$ (where a is a positive constant) is a constant times a^x .
- Describe the exponential function e^x in terms of its derivative.
- Note the useful modelling power of a function whose derivative is proportional to itself.

Chapter 4: Computing Derivatives

4.1: Arithmetic of derivatives

- Demonstrate using the limit definition of derivative that differentiation is linear.
- Use linearity to “break down” derivatives of sums and constant multiples.
- Use counterexamples to demonstrate that certain statements about derivatives are false.
- Explain why an example does not constitute a “proof”.
- Demonstrate the Power Rule for integer exponents using the limit definition of derivative.
- State and apply the Power Rule.
- Use the Product Rule to differentiate the product of functions.
- Use the Quotient Rule to differentiate the quotient of functions.

4.2: Trigonometric functions and their derivatives

- Review the definitions of trigonometric functions.
- Determine derivatives of trigonometric functions using the limit definition of derivative, trigonometric limits, addition formulas, and Product and Quotient Rules.
- Know the derivatives of sine, cosine, and tangent; be able to use those derivatives to find the derivatives of secant, cosecant, and cotangent.

4.3: The chain rule

- Use the chain rule to compute derivatives of compositions of functions.

4.4: Logarithmic differentiation

- Differentiate logarithmic functions.
- Determine when to use logarithmic differentiation to simplify derivatives.
- Use logarithmic differentiation.
- Use the generalized product rule to compute the derivative of products of many functions.

4.5: Implicit differentiation

- Explain how implicit differentiation is a consequence of the Chain Rule.
- Use implicit differentiation to find slopes of tangent lines to implicitly defined curves.

4.6: Inverse functions

- Understand what the inverse of a function is.

4.7: Inverse trig functions and their derivatives

- Sketch $f(x) = \arctan x$.
- Evaluate (at nice points) the inverse trigonometric functions $\arcsin(x)$, $\arccos(x)$ and $\arctan(x)$.
- Use implicit differentiation / chain rule to find the derivatives of the inverse trigonometric functions $\arcsin(x)$, $\arccos(x)$ and $\arctan(x)$.

Chapter 5: Related Rates

- Implement a sequence of steps to solve related rates problems.

Chapter 6: L'Hôpital's Rule and Indeterminate Forms

- Recognize the two types of indeterminate forms where L'Hôpital's rule is directly applicable.
- Use L'Hôpital's rule to evaluate limits; compare/contrast with asymptotics.

Chapter 7: Sketching Graphs

7.1: Domain, intercepts and asymptotes

- Sketch a function using information from precalculus (limits, intercepts) and its asymptotic behaviour.
- Efficiently find signs of factored functions (by determining where the signs change, or using another method).

7.2: First derivative — increasing or decreasing

- Determine where a graph is increasing or decreasing based on the signs of its first derivative. Represent this behaviour in a sketch.

7.3: Second derivative — concavity

- Explain what it means for a twice-differentiable function to be concave up or concave down on an interval.
- Determine whether a twice-differentiable function is concave up or concave down on an interval.
- Explain how information about the graph of a function may be extracted from the function, its derivative and its second derivative.
- Sketch the graph of a function $f(x)$ using the function, its derivative, and its second derivative.
- Sketch the graph of a function using characteristics determined from the function and its derivatives, *without* scaffolding from an external source.
- Recognize when functions are even, odd, or periodic, and understand how these properties influence the graph of a function.

Chapter 8: Optimization

- Determine the critical and singular points of a function.
- Identify local extrema of a function.
- Find the global extrema of a function on a closed interval.
- Explain how the algorithm can be used in optimization problems. (Note that finding a critical point is not enough to identify an extremum.)
- Convert geometric information into a function optimization problem.
- Interpret model optimization problems based on real-world examples according to their context.

Chapter 9: Approximating Functions Near a Specified Point— Taylor Polynomials

- Use a linear approximation to approximate a differentiable function that is difficult to evaluate exactly. This includes choosing an appropriate centre point.
- Use a linear approximation to approximate an irrational number with a rational number. This may include choosing an appropriate centre point as well as an appropriate function.
- Explain what a degree n approximation of a function is.
- Determine degree n approximations for appropriately differentiable functions.
- State the Maclaurin polynomials for the standard functions: $\frac{1}{1-x}$, e^x , $\cos x$, $\sin x$, $\log(1+x)$.

9.6: (Flavour A) Error in Taylor Polynomials

- Be able to use the formula for the error in Taylor polynomial approximations, and interpret its result. For example: determine a bound on the error of a polynomial approximation at a point; determine a range for which a particular approximation has an error within a certain tolerance; or determine which degree Taylor approximation will result in an error within a certain tolerance.

Chapter 10: (Flavour A) Newton's Method

- Given a function, find an integer that is reasonably close to the root.
- Given a differentiable function, find the x -intercept of the tangent line at a particular point.
- Explain how Newton's method works. That is, how you can use tangent lines to approximate the roots of a function.
- Write down the formula for Newton's method and explain what each term in the equation represents.
- Use Newton's method to estimate the root(s) of a function.
- Recognize pathological cases where Newton's Method doesn't converge to a root.

Chapter 11: (Flavours A, B) Introduction to Differential Equations

- Explain how a differential equation is different from an algebraic equation.
- Check whether a given function satisfies a differential equation.
- Understand basic differential-equation models of exponential growth and decay.
- Identify solutions to simple differential equations (of the form $y' = ay$) and interpret them in context.
- Given an initial condition, find a particular solution that satisfies a differential equation.

Chapter 12: (Flavours A, B) Solving differential equations

12.3: Euler's method and numerical solutions

- Explain how a differential equation may be solved computationally using linear approximations. That is, explain how Euler's method works.
- Explain what each term represents in the formula for Euler's method.
- Examine and compare computational (numerical) and exact (analytical) solutions to differential equations.
- Use Euler's method to solve a differential equation by hand (small number of steps)

Chapter 13: (Flavours A, B) Qualitative methods for differential equations

13.2: The geometry of change

- Find linear approximations of a solution to a DE, given a point.
- Sketch a linear approximation of a solution to a DE at a point.
- Interpret slope fields for a given differential equation and use them to roughly sketch solutions.

13.3: (Flavour B) State-space diagrams

- Explain what is meant by a “steady-state” solution.
- Find steady-state solutions to simple differential equations.
- Sketch a state-space diagram for a given differential equation and use it to describe the behaviour of solutions.
- Explain what it means for a steady-state solution to be “stable”. Determine the stability of a steady state.
- Use a state-space diagram to identify stability of steady states

Chapter 14: (Flavour C) Geometry in Three Dimensions

14.1: Points and planes

- Label points on the x - y - z axes and identify basic planes of constant x , y , or z .

14.2: Functions of two variables

- Given a simple function of two variables, $z = f(x, y)$, evaluate z values for given pairs (x, y) .

14.3: Sketching surfaces in 3D

Chapter 15: (Flavour C) Partial Derivatives

15.1: Partial derivatives

- Compute partial derivatives of two-variable functions.
- Provide a physical interpretation of a partial derivative in terms of directional steepness at a point on a surface.

15.2: Higher order derivatives

- Compute the second order partial derivatives given a function of two variables.
- State without proof that the mixed partials should be equal for “nice” functions.

Chapter 16: (Flavour C) Optimization of Multivariable Functions

16.1: Local maximum and minimum values

- Define critical point and singular point for a function of two variables.
- Compute the critical points and singular points of a given function of two variables.
- State (without proof) that extreme values of a continuous multivariable function will occur at critical or singular points.
- Be able to visualize critical points as ‘flat spots.’
- Use the second derivative test to classify critical points as either local maximums, local minimums, or saddle points.
- Explain using words or pictures what a saddle point is.

16.2: Absolute minima and maxima

- Reduce a constrained optimization problem in 3D, where the constraint is a single function (possibly with endpoints, possibly not), to a single-variable calculus problem.
- Understand that the global extrema of a two-variable function over a closed region occur along the boundary and/or at critical points of the interior
- Find the extreme values for a function of two variables on a closed region in cases where optimization on the boundary can be reduced to a single-variable calculus problem.

16.3: Lagrange multipliers

- Understand that solutions to a particular system of equations correspond to points along a curve that is locally flat.
- Use the method of Lagrange multipliers to find extrema along a constraint.
- Choose between the method of Lagrange multipliers, and simple plugging in, for determining extrema along a constraint.
- Find the absolute extrema of a surface over a closed region, using the appropriate method (Lagrange or plugging in) for investigating the boundary.